

Window automation technology

Automazione per sistemi
di evacuazione
fumo e calore (RWA)
e ventilazione naturale

Automation for smoke and
heat evacuation (RWA) and
natural ventilation systems





 **COMUNELLO**
MOWIN

General Catalogue



→ Index

6	Introduzione Introduction
12	La nuovissima Mowin App The brand new Mowin App
20	La tecnologia della sicurezza Security technology
22	L'estetica dell'invisibile The aesthetics of the invisible
24	Tipologie di aperture Types of opening
26	Sistema di fissaggio Agile Agile assembly system
28	Sincronizzazione Wi-Fi Wi-Fi synchronized
30	Smart home Smart home



48	Attuatori evacuazione fumo e calore - RWA Smoke and heat evacuation actuators - RWA
50	LIWIN L40
60	LIWIN L40 Slim - 350
70	LIWIN L40 Slim - 600
80	LIWIN L40 Slim - 800
90	LIWIN L40 Slim - 1000
100	BLOCK
102	Accessori - RWA - Accessories



108	Attuatori ventilazione naturale Natural ventilation actuators
114	SMART
124	STAR 25
134	STAR 30
144	FAST
152	LIWIN L20 Insert Wi-Fi
162	LIWIN L35 Slim
172	RAYWIN
192	AIRWIN
208	Accessori VN - NV Accessories



One Smart App



Mowin App®



Attuatori evacuazione fumo e calore - RWA
Smoke and heat evacuation actuators - RWA



Attuatori ventilazione naturale
Natural ventilation actuators



Sistema di installazione rapida AGILE
AGILE Rapid Installation System



Sincronizzazione multipla tramite Wi-Fi
Wi-Fi Multiple Actuator Synchronization



Sincronizzazione multipla
Multiple Actuator Synchronization



Tecnologia Wi-Fi
Wi-Fi Technology



Potenze disponibili
Power options available

→ Comunello Group dal particolare all'universale

Da oltre 50 anni in espansione

Comunello Group from the particular to the universal

Expanding for over 50 years

Dal particolare accessorio per cancelli scorrevoli, core business della prima azienda fondata da Vittorio Comunello nel 1965, ad un gruppo di 5 aziende leader nei settori di riferimento che esportano in oltre 105 Paesi nel Mondo. Tutti i prodotti di ciascuna azienda vengono progettati e realizzati interamente presso le relative sedi in Italia. Questo controllo totale sui processi produttivi garantisce il massimo livello di qualità negli accessori per cancelli e portoni industriali (COMUNELLO GATE), nei motori per cancelli, portoni e barriere (COMUNELLO AUTOMATION), nei componenti per infissi (COMUNELLO FRAME), nei maniglioni (HEXT) e nelle automazioni per finestre messe a punto negli stabilimenti COMUNELLO MOWIN.

From the particular accessory for sliding gates, the core business of the first company founded by Vittorio Comunello in 1965, to a group of 5 leading companies in the reference sectors which export to over 105 countries worldwide. All of the products of each company are designed and manufactured entirely at the relative offices in Italy. This total control over the production processes guarantees the highest level of quality in the accessories for industrial gates and doors (COMUNELLO GATE), in the motors for gates, doors and barriers (COMUNELLO AUTOMATION), in the components for fixtures (COMUNELLO FRAME), in the pull handles (HEXT) and in the window automation developed in the COMUNELLO MOWIN factories.





→ Research & design: il fulcro del nostro product development

Research & design: the core of our
product development

Da oltre 50 anni Ricerca e Design sono il fulcro dello sviluppo delle caratteristiche estetiche e formali del prodotto e da sempre sono fasi concettuali e pratiche che avvengono all'interno dei centri studio e dei laboratori presso la sede aziendale a Bassano del Grappa. Qui si concepiscono e si sperimentano le visioni del futuro.

For over 50 years, Research and Design have been the fulcrum of the development of the aesthetic and formal characteristics of the product and have always been conceptual and practical phases that take place within the study centers and laboratories at the company headquarters in Bassano del Grappa. Here visions of the future are conceived and experienced.

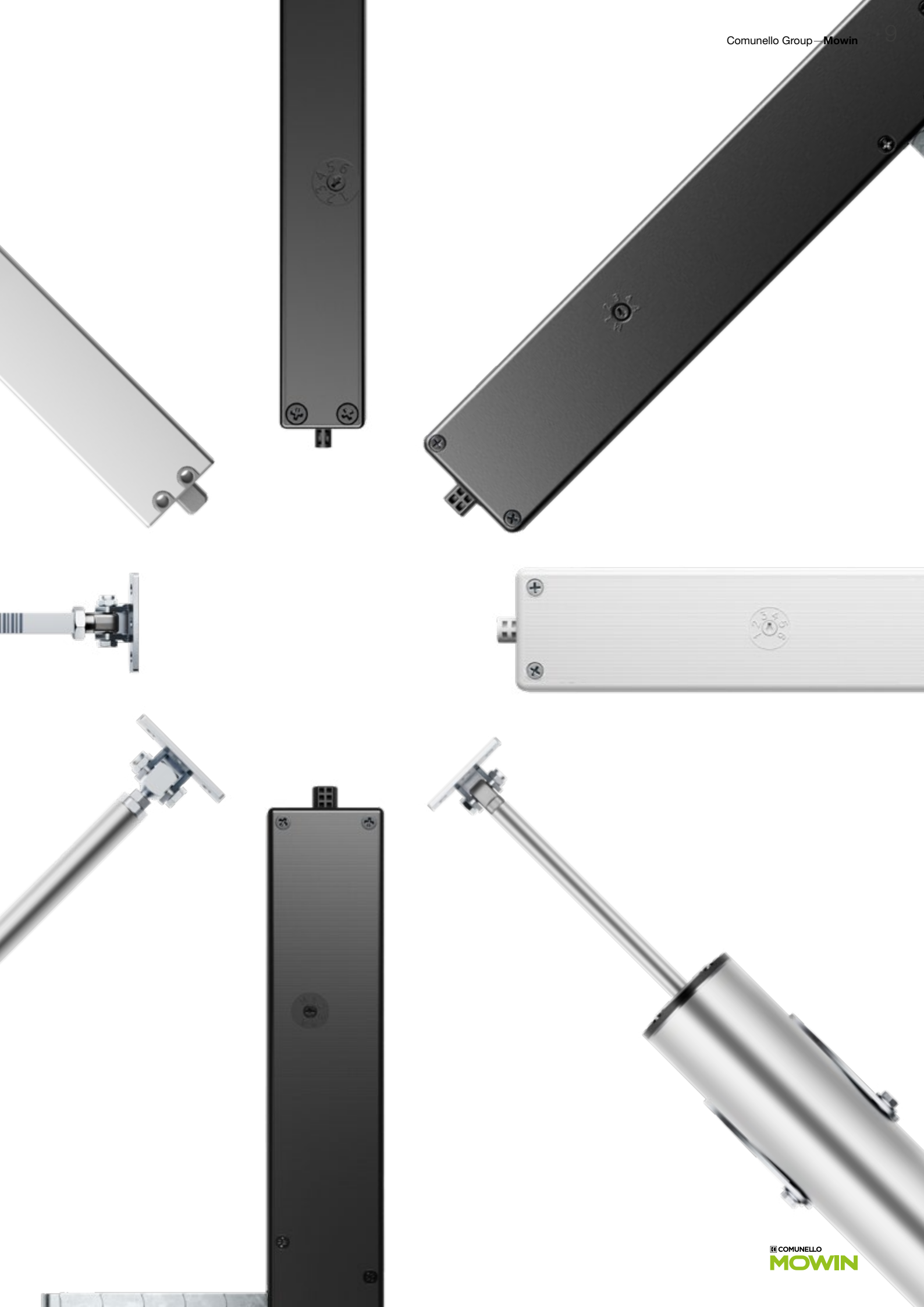

→ Produzione, quality control, customer care e technical service

All Made in Comunello

Production, quality control, customer
care and technical service

All made in Comunello

Per poter esercitare un controllo totale, e garantire così la massima qualità, ogni elemento viene prodotto in ogni sua parte all'interno degli stabilimenti Comunello che includono una fonderia dedicata, tecnologicamente avanzata ed efficiente. Rigorosamente made in Comunello anche la delicata fase dell'assemblaggio dei componenti elettronici di ogni singolo prodotto. Alla certezza della qualità, che si genera da queste scelte di base dell'azienda, per Comunello altrettanto importanti sono da sempre le garanzie dei servizi offerti alla propria clientela e cioè il supporto tecnico di personale qualificato e preparatissimo e l'assistenza in tutte le fasi della vendita e del post vendita.

In order to be able to exercise total control, and thus guarantee the highest quality, each element is produced in its entirety within the Comunello factories which include a dedicated, technologically advanced and efficient foundry. The delicate stage of assembling the electronic components of each individual product is also rigorously made in Comunello. To the certainty of quality, which is generated by these basic choices of the company, for Comunello the guarantees of the services offered to its customers have always been equally important, i.e. the technical support of qualified and highly trained personnel and assistance in all phases of sales and after-sales.



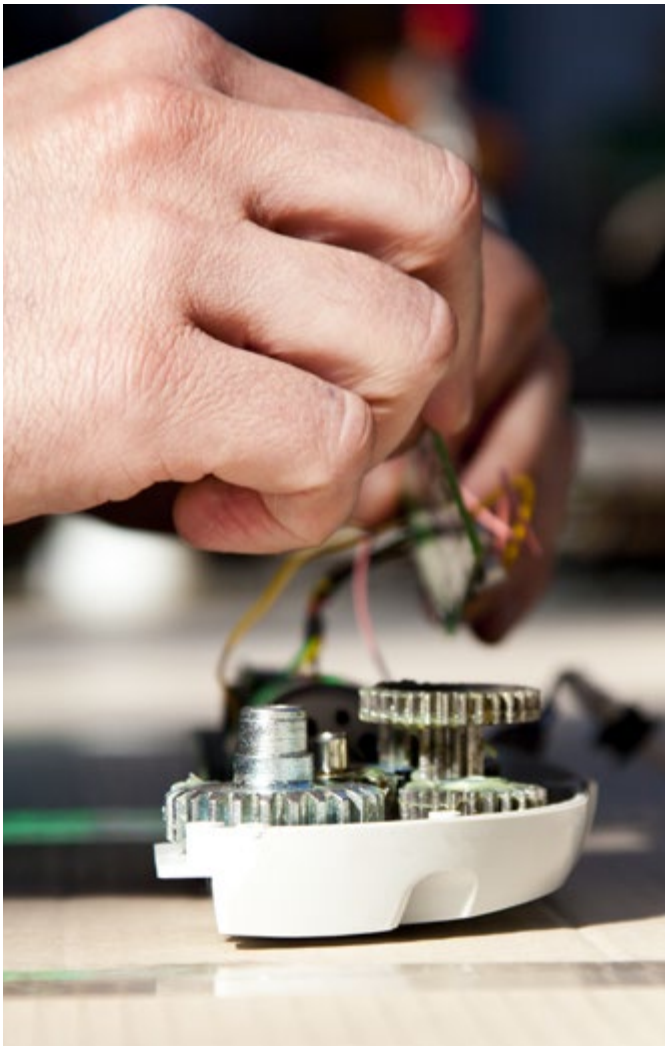

→ L'evoluzione intelligente dell'Interconnettività e della Sincronizzazione



La comunicazione diretta Sincronizzazione Wi-Fi

L'interconnettività IQ è un innovativo sistema di comunicazione wireless che, grazie al dispositivo Wi-Fi posto all'interno del motore e senza l'ausilio di router esterni, permette di connettersi con l'app MOWIN per la completa configurazione degli attuatori e garantire la perfetta sincronizzazione tra più attuatori installato sulla stessa finestra.

The direct communication Wi-Fi Synchronization

IQ interconnectivity is an innovative wireless communication system which, thanks to the Wi-Fi device placed inside the motor and without the aid of external routers, allows you to connect with the MOWIN app for complete configuration of the actuators and guarantee perfect synchronization between multiple actuators installed on the same window.

Gli attuatori della serie LIWIN nelle versioni Wi-Fi possono essere sincronizzati fino ad un massimo di 8 attuatori da installare in un'unica finestra. La sincronizzazione può essere effettuata tramite app o manualmente agendo sui trimmer degli attuatori ed è garantita da una comunicazione Wi-Fi stabile e sicura senza necessità di schede di interfaccia o collegamenti cablati tra gli attuatori.

The LIWIN series actuators in the Wi-Fi versions can be synchronized up to a maximum of 8 actuators to be installed in a single window. Synchronization can be performed via the app or manually by acting on the trimmers of the actuators and is guaranteed by stable and secure Wi-Fi communication without the need for interface cards or wired connections between the actuators.

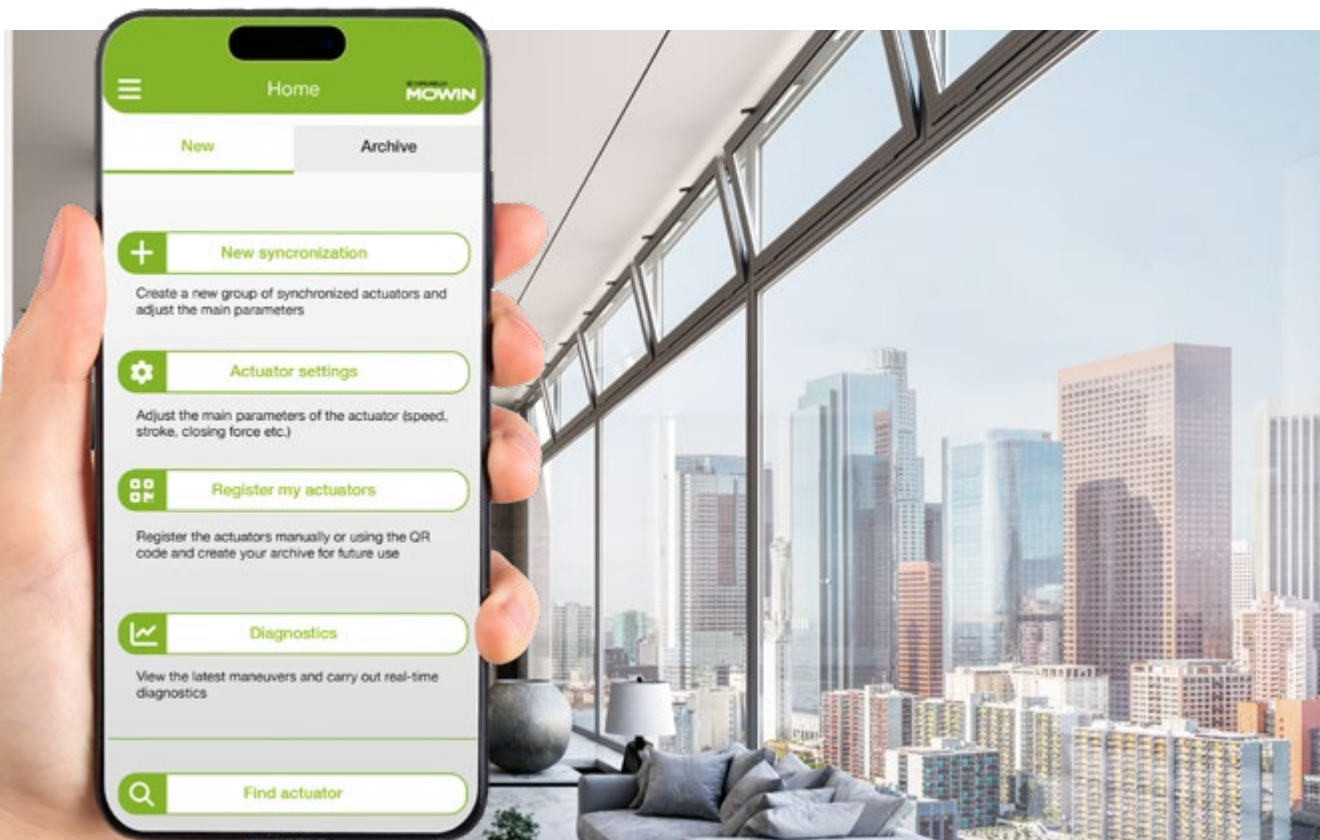

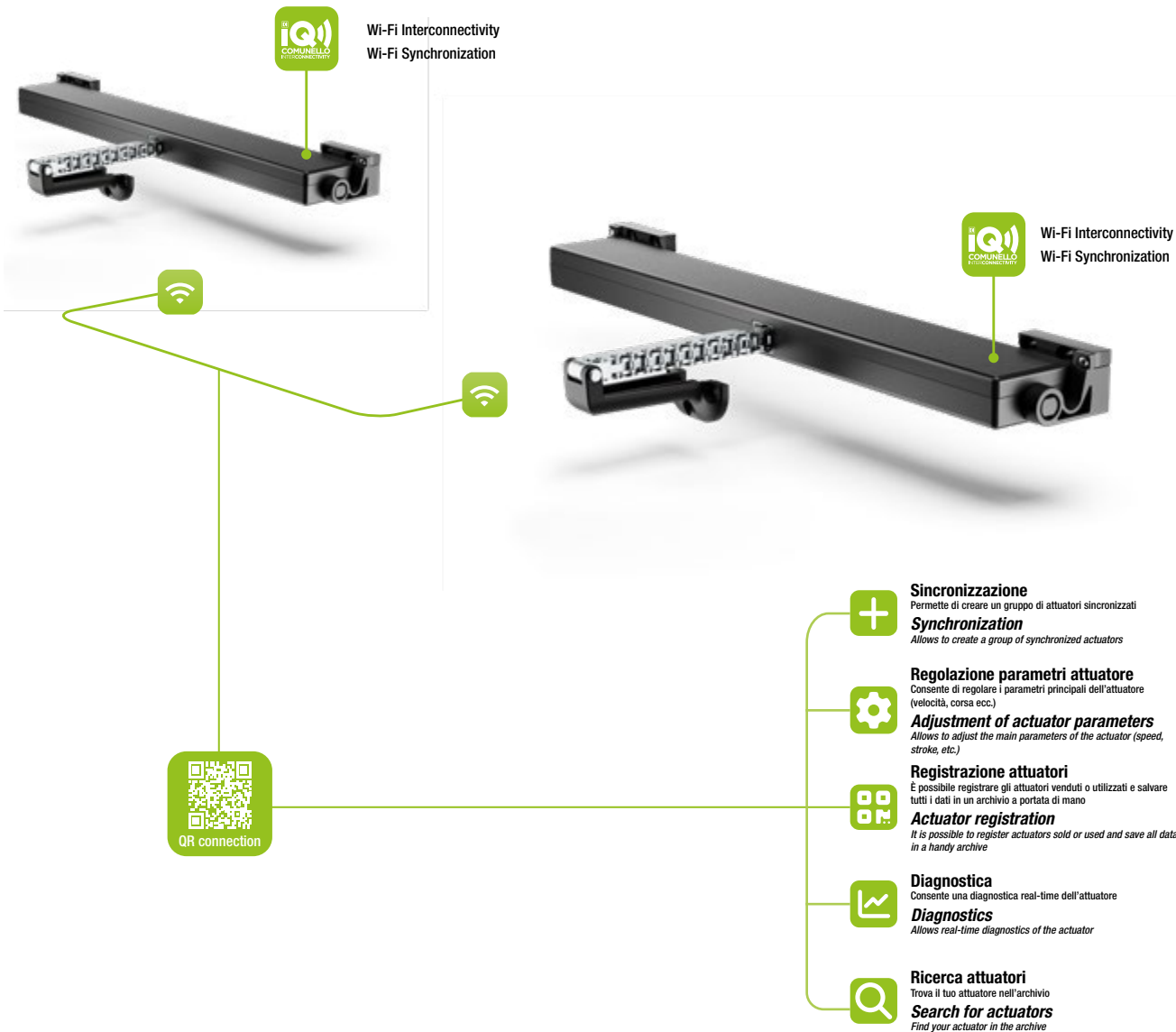

→ Sincronizzazione IQ Interconnectivity

Per tutte le lunghezze dell'anta
Wi-Fi Synchronization

Gli attuatori della serie LIWIN nelle versioni Wi-Fi possono essere sincronizzati fino ad un massimo di 8 attuatori da installare in un'unica finestra. La sincronizzazione può essere effettuata mediante app o manualmente intervenendo sui trimmer degli attuatori ed è garantita da una comunicazione Wi-Fi stabile e sicura senza la necessità di schede di interfaccia o di collegamenti filari tra gli attuatori.

For all sizes of window
Wi-Fi Synchronization

The LIWIN series actuators in the Wi-Fi versions can be synchronized up to a maximum of 8 actuators to be installed in a single window. Synchronization can be performed via the app or manually by acting on the trimmers of the actuators and is guaranteed by stable and secure Wi-Fi communication without the need for interface cards or wired connections between the actuators.

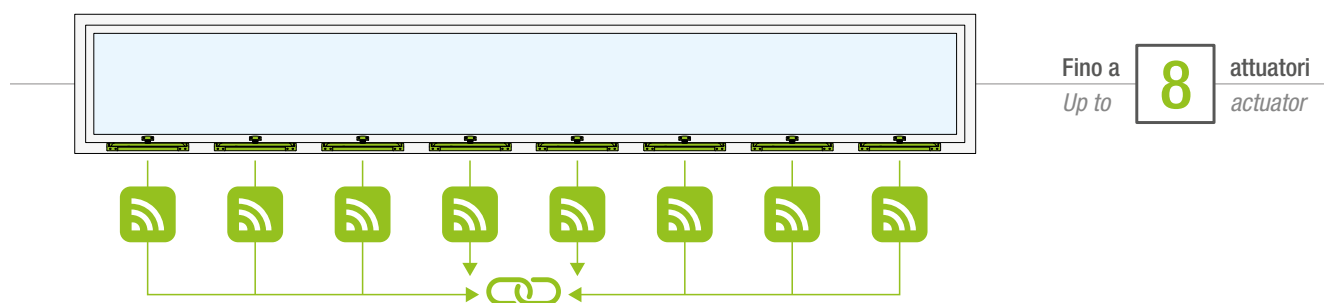

A seconda della rigidità del serramento si consiglia di installare almeno un attuttore ogni 1.5 metri di lunghezza della finestra come illustrato di seguito.

Depending on the stiffness of the window, it is recommended to install at least one actuator every 1.5 meters of window length.



Per ante fino a 1.5 metri

Per ante con lunghezza fino a 1.5 metri, se il serramento è sufficientemente rigido consigliamo l'installazione di un unico attuatore. Verificare che la forza sia sufficiente a movimentare il peso della finestra.

For leaves up to 1.5 metres

For leaves up to 1.5 metres long, if the window is sufficiently rigid, we recommend installing a single actuator. Check that the force is sufficient to move the weight of the window.

Attuatori indicati *Actuators indicated*

Tutti gli attuatori / *All actuators*

Comando a parete
Push-button



$L < 150$ cm
Base / Length

Fino a **30** finestre
Up to **30** windows

Per ante superiori a 1.5 metri

Con le versioni Wi-Fi degli attuatori **LIWIN L35 SLIM**, **L40**, **L40 SLIM** ed **L20 INSERT** è possibile installare più di un attuatore nella stessa finestra seguendo lo schema sotto riportato. La forza totale di spinta e trazione degli attuatori sincronizzati si calcola sommando la forza di ogni singolo attuatore e sottraendo il 30%.

For leaves wider than 1.5 metres

With the Wi-Fi versions of the **LIWIN L35 SLIM**, **L40**, **L40 SLIM** and **L20 INSERT** actuators it is possible to install more than one actuator in the same window by following the diagram below. The total thrust and traction force of the synchronized actuators is calculated by adding the force of each individual actuator and subtracting 30%.

Attuatori indicati *Actuators indicated*

LIWIN L35 slim Wi-Fi | **LIWIN L40 Wi-Fi** | **LIWIN L40 slim Wi-Fi** | **LIWIN L20 insert**

Comando a parete
Push-button

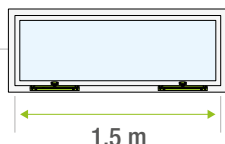

$L 150 < 300$ cm
Base / Length

Fino a **15** finestre
Up to **15** windows

Comando a parete
Push-button

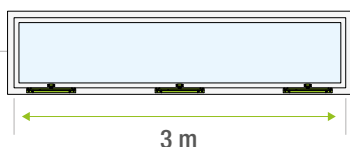

$L 300 < 450$ cm
Base / Length

Fino a **10** finestre
Up to **10** windows

Comando a parete
Push-button

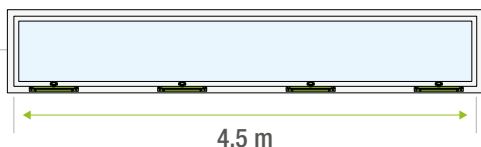

$L 450 < 600$ cm
Base / Length

Fino a **7** finestre
Up to **7** windows

Per ante superiori o che richiedono un forza maggiore contattare il service Comunello.

For higher windows or windows that require a more important force, contact the Comunello service department.

→ La nuovissima Mowin App

The brand new Mowin App

Cos'è la Mowin App?

La nuova APP MOWIN di Comunello è un'applicazione facile, intuitiva e graficamente rinnovata che può offrire numerosi vantaggi in termini di gestione delle vendite ed installazione di automazioni per finestre.

L'APP MOWIN è disponibile negli store IOS e ANDROID.

Perché la Mowin App?

I 3 principali vantaggi che rendono particolarmente utile l'app MOWIN sono:
GESTIONE DEL MAGAZZINO: grazie alla funzione "sincronizzazione" si può gestire a magazzino un solo codice che può essere utilizzato singolarmente o in sistemi sincronizzati.

GESTIONE DELLE VENDITE: tutti gli attuatori possono essere registrati al momento della vendita. I dati vengono salvati in un archivio a portata di mano.

INSTALLAZIONE: grazie alle regolazioni dei parametri principali è possibile adattare l'attuatore ad ogni esigenza ed applicazione. La diagnostica inoltre consente di risalire velocemente alle cause di eventuali malfunzionamenti.

What is the Mowin app?

The new MOWIN APP from Comunello is an easy, intuitive and graphically renewed application that can offer numerous advantages in terms of sales management and installation of window automation. The MOWIN APP is available in the IOS and ANDROID stores.

Why the Mowin app?

The 3 main advantages that make the MOWIN app particularly useful are:

WAREHOUSE MANAGEMENT: *Thanks to the "synchronization" function, a single code can be managed in the warehouse which can be used individually or in synchronized systems.*

SALES MANAGEMENT: *All actuators can be registered at the time of sale. The data is saved in a handy archive.*

INSTALLATION: *Thanks to the adjustments of the main parameters it is possible to adapt the actuator to every need and application. The diagnostics also allows you to quickly trace the causes of any malfunctions.*



Sincronizzazione Synchronization

Permette di creare un gruppo di attuatori sincronizzati.

Allows you to create a group of synchronized actuators.



Regolazione parametri attuatore Adjustment actuator parameters

Consente di regolare i parametri principali dell'attuatore (velocità, corsa ecc.)

It allows to adjust the main parameters of the actuator (speed, stroke, etc.)



Registrazione Attuatori Registration of Actuators

È possibile registrare gli attuatori venduti o utilizzati e salvare tutti i dati in un archivio a portata di mano.

It is possible to register the actuators sold or used and save all the data in a handy archive at your fingertips.

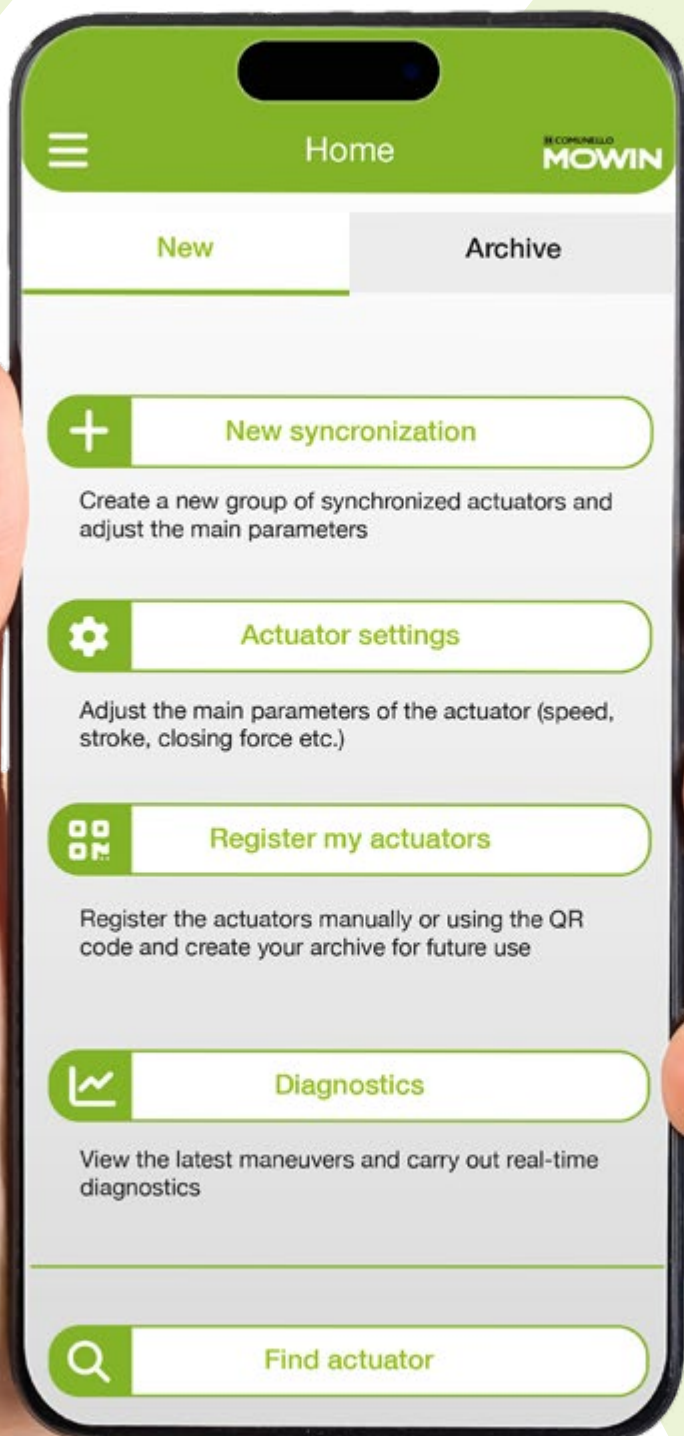

Diagnostica Diagnostics

Consente una diagnostica real time dell'attuatore.

Allows real-time diagnostics of the actuator.



Ricerca attuatori Find actuator

Trova il tuo attuatore nell'archivio.

Find your actuator in the archive.

→ Funzioni Mowin App: Sincronizzazione

Mowin App function: Synchronisation

Nel caso di più attuatori installati nella stessa finestra è fondamentale garantire la sincronizzazione tra gli stessi per preservare il serramento da eventuali rotture o deformazioni.

Grazie alla funzione "SINCRONIZZAZIONE" è sufficiente inquadrare i QRCode presenti all'esterno delle confezioni o nelle etichette degli attuatori per creare un sistema sincronizzato. Attraverso brevi passaggi guidati è infatti possibile sincronizzare un gruppo di attuatori, nominarlo e registrarlo nell'archivio con la relativa data di creazione ed eventuali note. Una volta creato e nominato un gruppo di attuatori è sufficiente collegarsi al Wi-Fi con un solo attuatore della famiglia per trasferire tutte le informazioni di sincronizzazione ed effettuare le regolazioni dei parametri principali di corsa catena, velocità ecc.

Al momento dell'installazione, una volta alimentati tutti gli attuatori, la nuova tecnologia Wi-Fi di Comunello consente la comunicazione e la trasmissione dei dati istantanea tra gli attuatori che diventano un sistema sincronizzato. È possibile sincronizzare fino ad 8 attuatori da poter installare nella stessa finestra. Gli attuatori sono in grado di variare la loro velocità singolarmente per garantire la sincronia tra di loro.

L'innovativo sistema di trasmissione dei dati Wi-Fi permette una corretta sincronia nel movimento degli attuatori durante la fase di apertura e di chiusura e garantisce una chiusura omogenea lungo tutta la lunghezza del serramento. Grazie ad un controllo millimetrico della corsa, in caso di malfunzionamento anche di un solo attuatore, tutto il sistema si ferma salvaguardando la meccanica del serramento.

Risparmio

Grazie alla comunicazione Wi-Fi non è necessario il collegamento filare tra gli attuatori; la sincronizzazione può essere effettuata dall'installatore a banco o in loco ad attuatori installati.

In the case of multiple actuators installed in the same window it is essential to ensure synchronization between them to preserve the window from any breakage or deformation.

Thanks to the "SYNCHRONIZATION" function, it is sufficient to scan the QRCode present on the outside of the packages or in the labels of the actuators to create a synchronized system. Through short guided steps it is in fact possible to synchronize a group of actuators, name it and record it in the archive with the relative creation date and any notes. Once a group of actuators has been created and named, it is sufficient to connect Wi-Fi with a single actuator in the group to transfer all the synchronization information and make the adjustments to the main parameters of chain travel, speed, etc.

At the time of installation, once all the actuators have been powered, the Comunello new Wi-Fi technology allows instantaneous communication and data transmission between the actuators which become one synchronized system. It is possible to synchronize up to 8 actuators to be installed in the same window. The actuators are able to vary their speed individually to ensure synchrony between them.

The innovative Wi-Fi data transmission system allows a correct synchrony in the movement of the actuators during the opening and closing phase and ensures uniform closing along the entire length of the window. Thanks to a millimetric control of the stroke, in the event of a malfunction of even just one actuator, the whole system stops, safeguarding the mechanics of the window.

Savings

Thanks to Wi-Fi communication, no wire connection is required between the actuators; synchronization can be done from the bench installer or on site to the installed actuators.

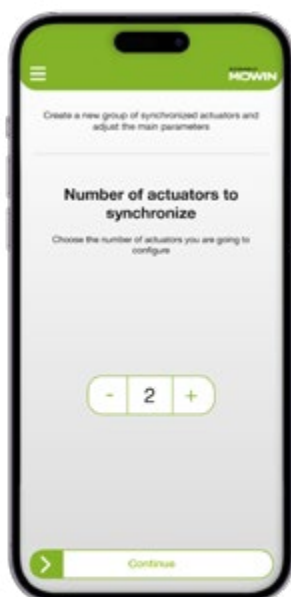

1. Decidi il numero di attuatori da sincronizzare.

1. Decide the number of actuators to synchronize.



2. Inquadra i QRCode degli attuatori.

2. Scan the QR Codes of the actuators.

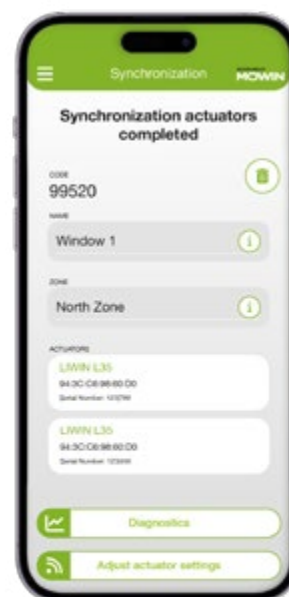

3. Nomina la famiglia di attuatori sincronizzati.

3. Name the family of synchronized actuators.



Attraverso l'app mowin con questi 3 semplici passaggi è possibile creare un sistema di attuatori sincronizzati. È quindi possibile anche in un secondo momento regolare i parametri principali di tutto il gruppo semplicemente alimentando uno solo degli attuatori.

Using the mowin app with these 3 simple steps it is possible to create a system of synchronized actuators. It is therefore also possible at a later time to adjust the main parameters of the whole group simply by powering just one of the actuators.

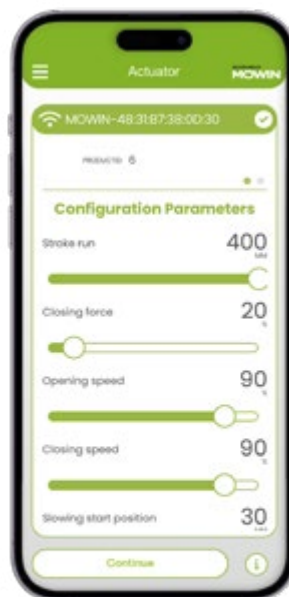
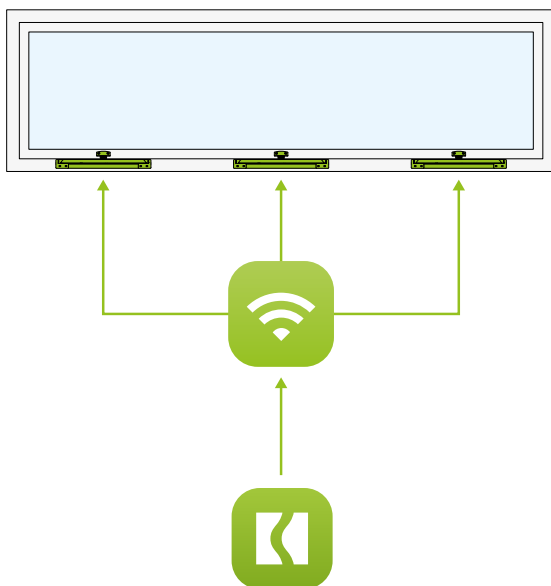

→ Funzioni Mowin App: Impostazioni

Programmazione e regolazione attuatori da app

Mowin App functions: Settings

Programming and adjusting actuators from app

Funzioni principali

La tecnologia Wi-Fi permette mediante l'app Mowin di interagire con l'attuatore e regolare alcuni dei parametri principali a seconda delle esigenze ed applicazioni. Tali regolazioni possono essere fatte in qualsiasi momento. È sufficiente alimentare l'attuatore e mediante la funzione "REGOLA PARAMETRI ATTUATORE" effettuare le regolazioni desiderate.

I parametri che si possono regolare sono:

Velocità

È possibile regolare la velocità di apertura e chiusura del serramento.

Forza di chiusura

Regolando questo parametro è possibile variare la pressione in chiusura dell'anta.

Corsa catena

L'app permette la regolazione millimetrica della lunghezza della catena.

Rilascio

Raggiunto il finecorsa in chiusura (per amperometrica) l'attuatore effettua una breve inversione del moto che è regolabile e consente di salvaguardare la meccanica dell'infisso e dell'automazione.

Main functions

The wifi technology allows the Mowin app to interact with the actuator and adjust some of the main parameters according to needs and applications.

These adjustments can be made at any time. It is sufficient to power the actuator and, using the "ADJUST ACTUATOR PARAMETERS" function, make the desired adjustments. The parameters that can be adjusted are:

Speed:

The opening and closing speed of the window can be adjusted.

Closing force

By adjusting this parameter it is possible to vary the closing pressure of the leaf.

Chain stroke

The app allows millimeter precision adjustment of the length of the chain

Release

Reached the closing limit switch (for amperometric) the actuator performs a brief inversion of the motion which is adjustable and allows to safeguard the mechanics of the window and of the automation.

FORZA / FORCE

VELOCITÀ / SPEED

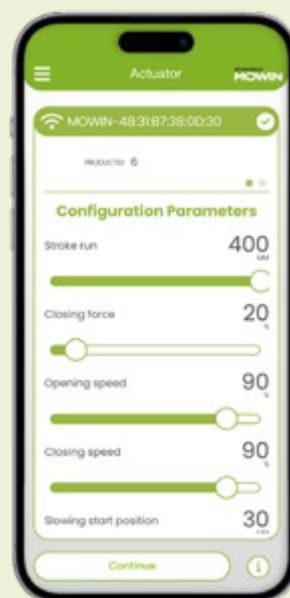

CORSA / STROKE

RILASCIO / RELEASE

→ Registra i miei attuatori

Register my actuators

Registrazione Attuatori

È possibile registrare in cloud qualsiasi attuatore Comunello con tecnologia Wi-Fi. Semplicemente inquadrando il QRCode nelle etichette dell'imballo o negli attuatori stessi si può risalire al tipo di attuatore con relativo numero di serie al quale si possono aggiungere tutte le informazioni che si desidera salvare.

Tutte le informazioni inserite con la registrazione vengono salvate in archivio e sarà sufficiente inquadrare nuovamente il QRCode per poterle consultare in qualsiasi momento.

In alternativa inserendo una parola chiave nella ricerca dell'archivio si riesce a risalire a tutte le informazioni salvate.

Accedere all'archivio degli impianti

Qualsiasi operazione di registrazione, sincronizzazione, o regolazione viene registrata in cloud e potrà essere facilmente consultabile nella sezione «archivio» dell'app. Inserendo il nome impianto oppure semplicemente inquadrando il QRCode si riesce a risalire direttamente a tutte le informazioni registrate relative a quell'attuatore. Attraverso l'archivio, inquadrando il QRCode di un attuatore è possibile ad esempio individuare se l'attuatore fa parte di un sistema sincronizzato o se ha ancora le impostazioni di fabbrica.

Registration of Actuators

Any Comunello actuator can be registered in the cloud with wifi technology. Simply by scanning the QRCode on the packaging label or on the actuators themselves, the actuator type can be traced with its serial number to which you can add all the information you want to save. All the information entered with the registration is saved in the archive and it will be sufficient to scan the QRCode again to be able to consult it at any time. Alternatively, by inserting a keyword in the archive search, it is possible to go back to all the saved information.

Access the systems archive

Any record, sync, or adjustment operation is recorded in the cloud and can be easily consulted in the «archive» section of the app. By entering the system name or simply by framing the QRCode you can trace it directly to all recorded information relating to that actuator.

Through the archive, by scanning the qrcode of an actuator it is possible, for example, to identify if the actuator is part of a synchronized system or if it still has the factory settings.

1. Entra nella funzione "Registra i miei Attuatori"
1. Enter the "Register my Actuators" function



2. Inquadra i QRCode degli attuatori che vuoi registrare
2. Scan the QRcodes of the actuators you want to register



3. Nomina l'impianto e tutte le informazioni verranno salvate nel tuo archivio
3. Name the plant and all the information will be saved in your archive

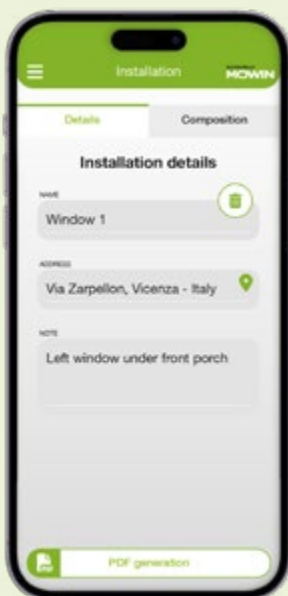

→ Funzioni Mowin App: Diagnostica

Mowin App Functions: Diagnostics

L'applicazione «MOWIN» consente di effettuare una diagnostica puntuale sullo stato delle automazioni. In particolare è dotata di memoria eventi che permette di registrare le ultime manovre eseguite e verificare se ci sono state eventuali anomalie. È sufficiente inoltre alimentare l'attuatore per eseguire un test di diagnostica in tempo reale effettuando delle manovre di apertura e chiusura e ricevendo un feedback puntuale sull'esito della manovra.

L'app infatti è in grado di visualizzare sia nella memoria eventi che nel test real time una serie di errori che permettono di individuare la tipologia di mal funzionamento riscontrato durante la manovra:

Errore di sovraccarico

Errore ostacolo

Errore sincronizzazione

Grazie alla funzione DIAGNOSTICA dell'app Mowin è quindi possibile verificare se ci sono delle anomalie, risalire alla causa di eventuali malfunzionamenti ed intervenire in maniera veloce e puntuale nella risoluzione del problema.

The «MOWIN» application allows you to carry out precise diagnostics on the status of the automation systems. In particular, it is equipped with both an event memory that allows you to record the last manoeuvres performed and check if there have been any anomalies. Furthermore, it is sufficient to power the actuator to perform a diagnostic test in real time by carrying out opening and closing manoeuvres and receiving timely feedback on the outcome of the manoeuver.

In fact, the app is able to display a series of errors both in the events memory and in the real-time test, which allow for the identification of the type of malfunction encountered during the manoeuver:

Overload error

Obstacle error

Sync Error

Thanks to the DIAGNOSTICS function of the Mowin app it is therefore possible to check if there are any anomalies, trace the cause of any malfunctions and intervene quickly and promptly in solving the problem.



Entra nella funzione "Diagnostica"
Enter the "Diagnostics" function



Inquadra il QRCode dell'attuatore che desideri diagnosticare
Scan the QRCode of the actuator you wish to diagnose

1. MANOVRE TOTALI / TOTAL MANOEUVERS

L'app indica il numero di manovre totali effettuate dall'installazione.

The app indicates the total number of manoeuvres performed since installation.

2. ULTIME MANOVRE / TOTAL MANOEUVERS

L'app visualizza le ultime manovre effettuate specificando se sono andate a buon fine o se ci sono state eventuali anomalie. Il pallino verde indica le aperture/chiusure completate mentre il pallino rosso indica un'anomalia con relativa tipologia di errore.

The app displays the last manoeuvres carried out, specifying if they were successful or if there were any anomalies. The green dot indicates the openings/closures completed while the red dot indicates an anomaly with relative type of error.

3. APRI/CHIUDI REAL TIME / OPEN/CLOSE REAL TIME

È possibile inviare dei comandi apri - chiudi direttamente dall'app per verificare in tempo reale il comportamento dell'attuatore.

It is possible to send open - close commands directly from the app to check the behavior of the actuator in real time.

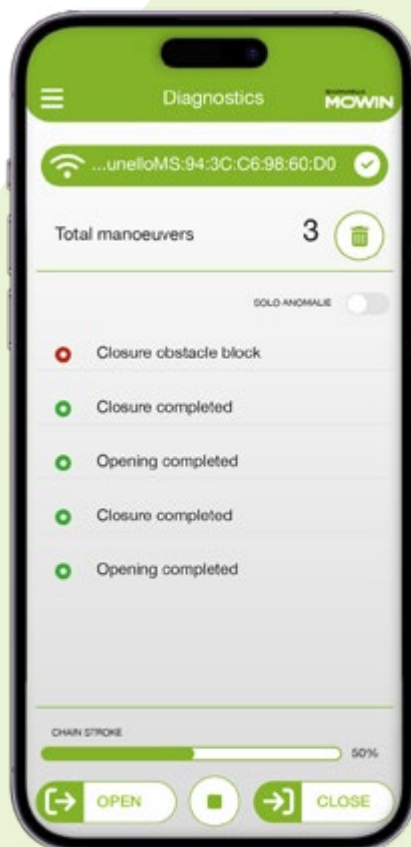

La tecnologia della sicurezza

Security technology





Wi-Fi



Mowin App



Test RWA
SHEVS Test

Prestazione - Certificata
Certified performance

Sistemi di controllo di fumo e calore

Accanto a soluzioni tecniche che garantiscono performance di prodotto sempre più innovative, affidabili e precise, la sicurezza occupa nella ricerca e nello sviluppo delle tecnologie una posizione di primaria importanza. I nuovi dispositivi di controllo del fumo e del calore, nella prevenzione antincendio, ne sono la prova.

Si tratta di sistemi di evacuazione di fumo e calore generalmente associati alla sigla RWA che deriva dalla nomenclatura tedesca Rauch und Warm Abzug. La centralina RWA è in grado di gestire sistemi di evacuazione e calore e ventilazione naturale con attuatori Comunello e relativi accessori. Può essere inoltre interfacciata alle centraline antincendio.

Smoke and heat control systems

Alongside technical solutions that guarantee increasingly innovative, reliable and precise product performance, safety occupies a position of primary importance in the research and development of technologies. The new smoke and heat control devices in fire prevention are proof of this.

These are smoke and heat evacuation systems generally associated with the acronym RWA which derives from the German nomenclature Rauch und Warm Abzug. The RWA control unit is able to manage evacuation and heat and natural ventilation systems with Comunello actuators and relative accessories. The systems can also be interfaced with fire control units.



L'Estetica dell'invisibile

Dimensioni minime, qualità massima

The aesthetics of the invisible

Minimum size, maximum quality

Ottimizzazione e materiali di prima scelta

La scelta estetica di un design tra i più ridotti in dimensione disponibili sul mercato risponde alla precisa volontà di offrire prodotti innovativi, funzionali ed affidabili, ma sempre meno invasivi. Le soluzioni più avanzate proposte da COMUNELLO MOWIN prevedono la possibilità di inserire i motori all'interno del serramento. Un'ottimizzazione che incontra il gusto di designer e architetti. Al principio della qualità assoluta, istituzionale e storico in Comunello, fa riferimento la scelta di impiegare materiali qualitativamente di massimo livello.

Optimization and first class materials

The aesthetic choice of a design among the smallest in size available on the market responds to the specific desire to offer innovative, functional and reliable products, but less and less invasive. The most advanced solutions proposed by COMUNELLO MOWIN provide for the possibility of inserting the motors inside the window profile. An optimization that meets the taste of designers and architects. The decision to use materials of the highest quality refers to the principle of absolute institutional and historic quality in Comunello.

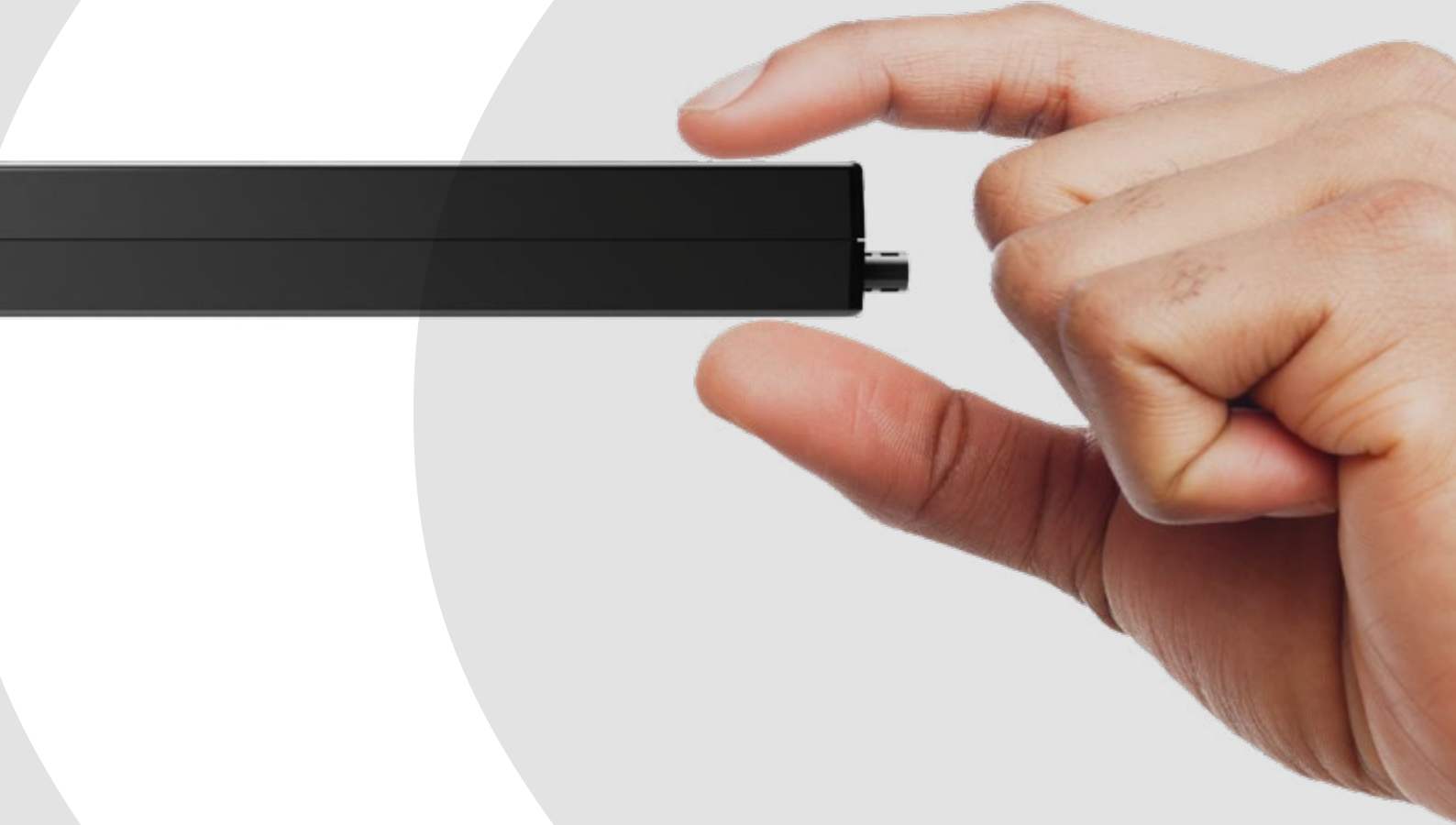

→ Tipologie di aperture

Types of opening



Battente Side hung

Finestra standard incernierata da un lato ed apribile verso l'interno. Adatta ad una aerazione ampia che sfrutta tutta la superficie del serramento.

Standard window hinged on one side and can be opened inwards. Suitable for wide ventilation that exploits the entire surface of the window.

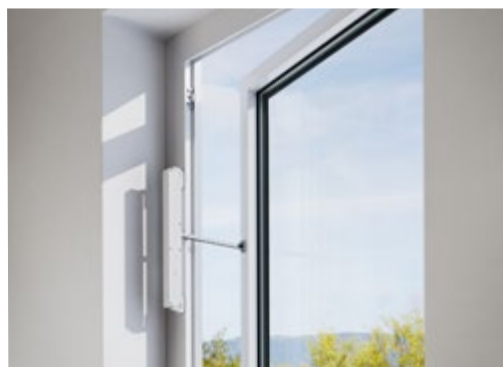

A Sporgere Top hung, outward opening

Finestre incernierate nella parte superiore ed apribili, verso l'esterno, nella parte inferiore. Adatte ad una aerazione parziale che non raggiunge direttamente l'utente. Utilizzabili anche durante le giornate di pioggia.

Outward opening - Are top hung with the bottom part of the sash opening outwards. This type of window is especially suitable for indirect and draught-free ventilation that can be utilised even in inclement weather conditions.



Bilico Pivot

Tipologia di serramento con un duplice vantaggio: da un lato permette la ventilazione totale, dall'altro semplifica le operazioni di pulizia grazie al comodo rovesciamento della finestra.

Pivot casement is a window which provides a dual function. On the one hand it allows total ventilation utilising the full section of the opening, and on the other hand it allows easy cleaning because the casement can be pivoted to gain access to the exterior face.



Vasistas Bottom hung, inward opening

Finestre incernierate nella parte inferiore ed apribili, verso l'interno, nella parte superiore. Adatte ad una aerazione parziale che non raggiunge direttamente l'utente. Sfruttabile anche durante giornate di pioggia.

Inward opening are bottom hung, with the top part of the sash opening inwards. This window is especially suitable for indirect and draught-free ventilation, even in inclement weather conditions.





Apertura Parallela Parallel

Tipologia di apertura verso l'esterno in cui la finestra si apre parallelamente alla facciata su cui è installata.

Type of outward opening in which the window opens parallel to the facade on which it is installed.



Frangisole Louvre

Oscura gli ambienti interni e regola l'ingresso di luce. Migliora l'isolamento termico quando è in posizione completamente verticale.

Solar shading blades - Apart from darkening the room and modulating the entry of sunlight, when the system is moved to a fully vertical position it increases the heat insulation performance of the building.



Cupolini Domes

È l'apertura orizzontale classica per l'aerazione di edifici industriali. Il cupolino è solitamente sostenuto da cerniere, perni o bracci.

Dome - It is the classic horizontal opening for the ventilation of industrial buildings and is usually supported by hinges, pins or arms.

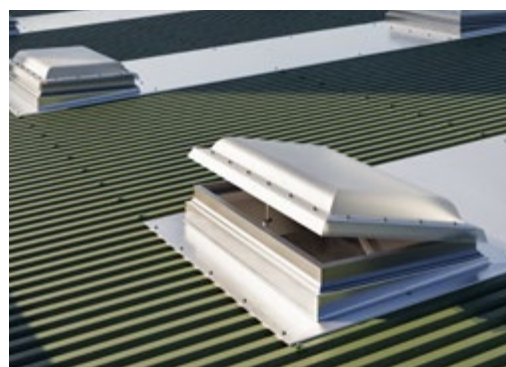

Lucernai Skylights

Apertura ideale per la ventilazione e l'illuminazione del sottotetto. Il lucernaio è usato sia in ambito residenziale che commerciale.

Skylight - It's the perfect opening for ventilation and lighting under roof. Used in both residential and commercial fields.



Shed Shed

Rappresenta in modo estremo la tipologia dell'apertura a sporgere garantendo ampia illuminazione e ventilazione all'interno delle strutture per uso industriale e rendendo l'abitabilità quanto più confortevole all'interno delle strutture stesse.

Shed provides a comprehensive representation of the top hung window, ensuring ample illumination and ventilation of the interior of industrial facilities, maximising the level of occupancy comfort.



→ Sistema di fissaggio Agile

Agile assembly system



Nuove staffe «AGILE»

Le innovative staffe di supporto in metallo «AGILE», disponibili per la serie L35 e per i modelli L40 e L40 SLIM, sono composte da 2 pezzi: il primo, di ingombro minimo, può già essere fissato al serramento durante la fase di produzione in fabbrica, mentre il secondo viene facilmente agganciato al momento dell'installazione dell'attuatore direttamente in cantiere.

New «AGILE» brackets

The innovative «AGILE» support brackets, available for the L35 series and for the L40 and L40 SLIM models, are made up of 2 pieces: the first, which takes up minimal space, can be fixed to the frame during the factory production, while the second is easily hooked up when the actuator is installed directly on site.

01. La staffa AGILE è composta di 2 pezzi.

01. The AGILE bracket consists of 2 pieces.



02. Un pezzo, con ingombro minimo, può essere installato in fabbrica prima di trasportare il serramento in cantiere.

02. One piece, occupying minimum space, can be installed in the factory before transporting the frame to the construction site.



03. Al momento dell'installazione del serramento è sufficiente agganciare le staffe e bloccarle con una vite.

03. At the moment of the installation of the window it is sufficient to hook on the brackets and block them with a screw.



Vantaggi

Questa soluzione offre diversi vantaggi in termini di semplicità di installazione ma soprattutto di comodità di trasporto.

L'installazione direttamente in fabbrica di un solo pezzo della staffa AGILE limita notevolmente l'ingombro rispetto all'installazione della staffa completa. Questo facilita l'operazione di trasporto dei serramenti in cantiere riducendo la possibilità di rottura delle staffe stesse. Al momento dell'installazione l'aggancio dell'attuatore alle staffe è facile ed immediato.

1. Trasporto facile e sicuro.

L'ingombro minimo delle staffe facilita l'operazione di trasporto.

1. Easy and safe transportation.

The minimum size of the brackets facilitates the transport operation.



2. Semplicità d'installazione.

L'aggancio delle staffe è facile, veloce e sicuro.

2. Ease of installation.

The hooking of the brackets is easy, fast and safe.

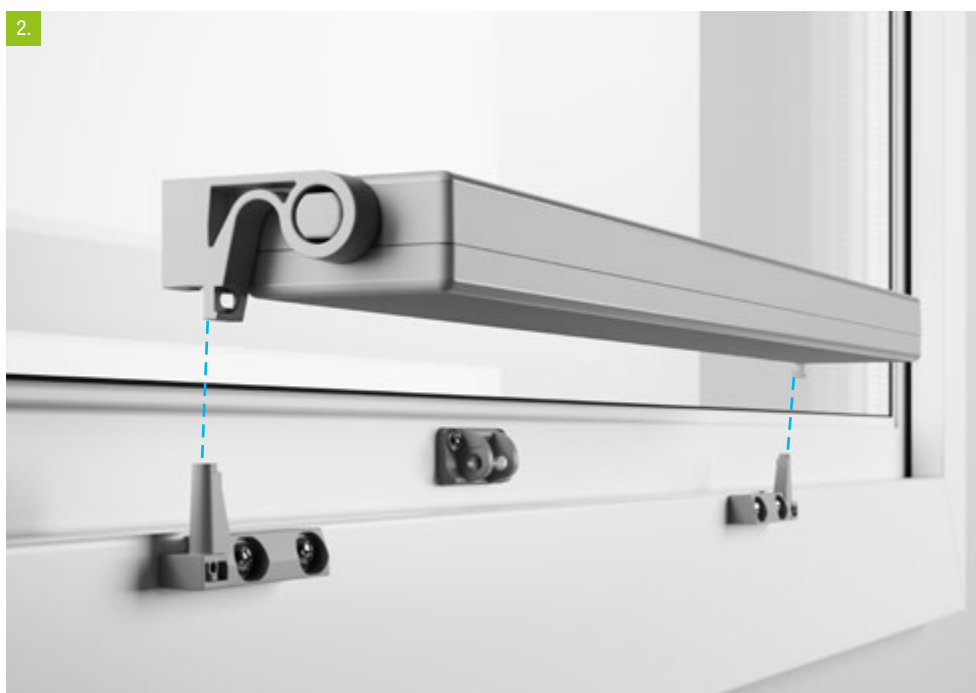

Advantages

This solution offers various advantages in terms of simplicity of installation but above all of ease of transport. The installation directly in the factory of a single piece of the AGILE bracket considerably limits the overall dimensions compared to the installation of the complete bracket. This facilitates the operation of transporting the windows to the construction site, reducing the possibility of breaking the brackets themselves. At the time of installation, the coupling of the actuator to the brackets is easy and immediate.

→ Smart home: connectivity made easy

Le centrali di comando Comunello integrano ingressi per il comando filare, ricevente RF 433,92MHz e modulo WiFi. Grazie alla tecnologia Cloud è possibile controllare un dispositivo da qualsiasi parte nel mondo. È sufficiente una connessione internet WiFi 2,4 GHz per configurare in pochi minuti un dispositivo OneSmart e gestire fino a 50 installazioni in luoghi differenti con 1000 dispositivi ciascuna. Le funzioni principali sono:

Controllo remoto

Con OneSmart è possibile controllare i dispositivi da qualsiasi parte nel mondo, creare programmazioni orarie e scenari.

Sistema multi-impianto

Con un'unica interfaccia è possibile controllare fino a 50 impianti sparsi nel mondo.

Programmazione oraria

Programmi orari e settimanali di apertura o chiusura. È possibile impostare un evento ad un preciso orario o per fasce orarie.

Scenario

Con una semplice programmazione è facile realizzare tasti che inviano comandi su più dispositivi in modo simultaneo.

Notifica eventi

È possibile ricevere un messaggio di notifica al verificarsi di un evento, come per esempio la chiusura di una finestra.

Centralizzazione

È possibile comandare i dispositivi in modo singolo o in gruppo creando facili comandi di apertura o chiusura totale.

Controllo meteo

È possibile impostare un'azione di apertura o chiusura in base alle condizioni atmosferiche.

Installazione facile

Non è necessario installare nessun gateway, è sufficiente una connessione internet WiFi 2,4 GHz per configurare in pochi minuti un dispositivo OneSmart

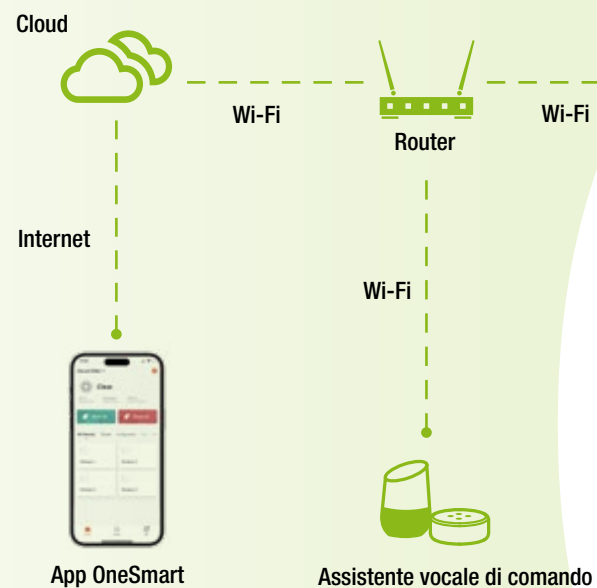
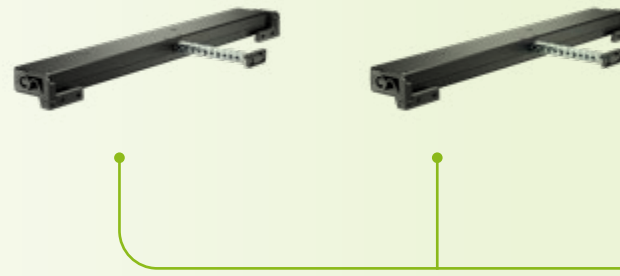

App OneSmart

Assistente vocale di comando per la gestione dei dispositivi OneSmart tramite voce.

Command voice assistant for managing OneSmart devices via voice.

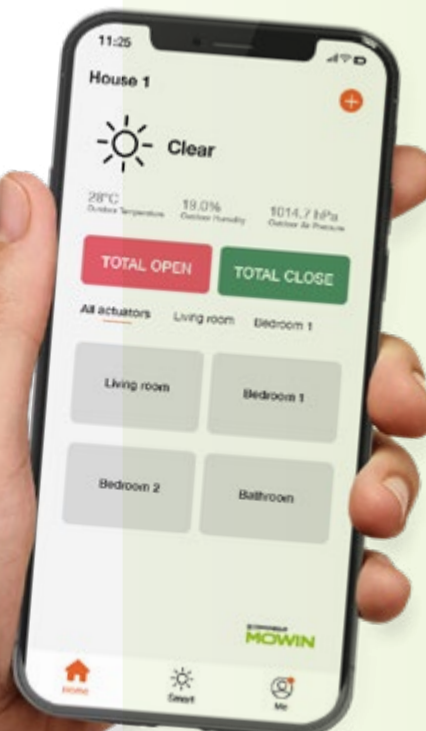



RF

**Radiocomandi***Radio controls***Comando push filare***Wired push command***Rilevatore vento per centrale RWA***RWA comand unit wind sensor***Rilevatore di pioggia***Rain sensor*

Comunello control units integrate inputs for wired control, 433.92MHz RF receiver and WiFi module. Thanks to Cloud technology it is possible to control a device from anywhere in the world. A 2.4 GHz WiFi internet connection is sufficient to configure a OneSmart device in just a few minutes and manage up to 50 installations in different places with 1000 devices each.

The main functions are:

Remote Control

With OneSmart it is possible to control the devices from anywhere in the world, create time schedules and scenarios.

Multi-plant system

With a single interface it is possible to control up to 50 systems around the world.

Hourly programming

Hourly and weekly opening or closing programs. It is possible to set an event at a precise time or by time slots.

Scenario

With simple programming it's easy to make keys that send commands on multiple devices simultaneously.

Event Notification

It is possible to receive a notification message when an event occurs, such as the closing of a window.

Centralization

It is possible to control the devices individually or in groups, creating easy total opening or closing commands.

Weather Check

It is possible to set an opening or closing action based on the weather conditions.

Easy installation

It is not necessary to install any gateway, a 2.4 GHz WiFi internet connection is sufficient to configure a device in just a few minutes One Smart

→ Smart home accessori

Smart home accessories



AF-800
Modulo Radio 110-240 Vac
Radio Module 110-240 Vac

cod. MX00 AU 05 H 0W 00



AF-820
Modulo Radio / WIFI
110-240 Vac
*Radio / Wifi Module
110-240 Vac*

cod. MX00 AU 06 H 0W 00



AF-840
Modulo Radio / Sensori meteo
110-240Vac
*Radio / Weather sensors
module 110-240Vac*

cod. MX00 AU 07 H 0W 00



AF-850
Modulo Radio / WiFi / Sensori
meteo 110-240Vac
*Radio / WiFi / Weather sensors
module 110-240Vac*

cod. MX00 AU 08 H 0W 00



AF-860
Modulo Radio / WiFi / Contatti
NO 24V
*Radio/ WiFi / NO contact
module 24V*

cod. MX00 AU 09 L 0W 00



AF-880
Radiocomando 1 canale
Remote control 1 channel

cod. MX00 AT 11 N 0B 00



AF-890
Radiocomando 6 canali
Remote control 6 channels

cod. MX00 AT 16 N 0B 00



AF-870
Comando a muro radio 1 canale
*Wall mounted radio control 1
channel*

cod. MX00 AT 10 N 0W 00



Rilevatore vento sole
Wind sun sensor

cod. MX00 AR 02 N 0T 00



Rilevatore di pioggia
Rain sensor

cod. MX00 AR 01 N 0T 00

Attuatori compatibili / Compatible actuators



LIWIN L40 / L40
SLIM



BLOCK



SMART



STAR



LIWIN L20 / L35



FAST



RAYWIN



AIRWIN



Sensori di pioggia e vento/sole.
Rain and wind/sun sensors.



Centrale di comando a scomparsa per controllo finestre e tapparelle motorizzate.
Concealed control unit for controlling motorized windows and rolling shutters.



Attivatore tramite pulsante radio Rolling Code.
Activator via Rolling Code radio button.



Assistente vocale di comando per la gestione dei dispositivi OneSmart tramite voce.
Command voice assistant for managing OneSmart devices via voice.



Radiocomando multi-canale per il controllo di finestre e tapparelle.
Multi-channel remote control for controlling windows and shutters.



Controllo remoto con Smartphone tramite connessione Wi-Fi.
Remote control with Smartphone via Wi-Fi connection.

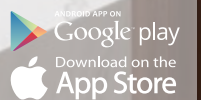

→ Smart home accessori

Smart home accessories



AF-800

Centrale per comandare attuatori 230Vac mediante radiocomando o pulsante filare: alimentazione 110/240Vac, 2 ingressi filari impostabili con funzione passo-passo o uomo presente, 1 uscita di potenza massima 500W per attuatori 230Vac, ricevente radio 433,92MHz.

Control unit for controlling 230Vac actuators by radio control or wired button: 110/240Vac power supply, 2 wired inputs that can be set with step-by-step or dead-man function, 1 output of maximum power 500W for 230Vac actuators, 433.92MHz radio receiver.

Codice / Code	MX00 AU 05 H 0W 00
Alimentazione / Power supply	110-240 Vac
Uscita / Output	1 x Max 500W Motori a 3 fili con fincorsa / 3 wires tubular motors
Funzione / Function	Apre/Stop/Chiude Open/Stop/Close
Ingressi / Input	2 pulsanti NA impostabili 2 NO push buttons
Trasmettitori Programmabili Programmable Transmitters	30
Frequenza radio / Radio Frequency	433.920MHz ISM
Grado di protezione / Protection rating	IP20
Temperatura di funzionamento / Working Temperature	-20 +55 °C
Dimensioni / Dimensions	67x43x21 mm

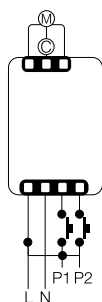

AF-820

Centrale per comandare attuatori 230Vac mediante app OneSMART, radiocomando, pulsante filare o comando vocale: alimentazione 110/240Vac, 2 ingressi filari impostabili con funzione passo-passo o uomo presente, 1 uscita di potenza massima 500W per attuatori 230Vac, ricevente radio 433,92MHz, modulo WiFi integrato per il controllo remoto tramite App OneSmart e comando vocale.

Control unit for controlling 230Vac actuators via OneSMART app, remote control, wired button or voice command: 110/240Vac power supply, 2 wired inputs that can be set with step-by-step or dead man function, 1 output with maximum power 500W for 230Vac actuators, 433.92MHz radio receiver, integrated WiFi module for remote control via OneSmart App and voice command.

Codice / Code	MX00 AU 06 H 0W 00
Alimentazione / Power supply	110-240 Vac
Uscita / Output	1 x Max 500W Motori a 3 fili con fincorsa / 3 wires tubular motors
Funzione / Function	Apre/Stop/Chiude Open/Stop/Close
Ingressi / Input	2 pulsanti NA impostabili 2 NO push buttons
Trasmettitori Programmabili / Programmable Transmitters	30
Frequenza radio / Radio Frequency	433.920MHz ISM
Wireless Smart	WiFi 2,4GHz
Controllo Smart remoto / Smart Remote control	App OneSmart
Controllo Vocale / Voice control	Google Home, Alexa Amazon
Grado di protezione / Protection rating	IP20
Temperatura di funzionamento / Working Temperature	-20 +55 °C
Dimensioni / Dimensions	67x43x21 mm

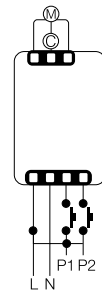

AF-840

Centrale per comandare attuatori 230Vac mediante radiocomando o pulsante filare: alimentazione 110/240Vac, 3 ingressi filari impostabili con funzione passo-passo, uomo presente o sensori meteo, 4 uscite di potenza massima 500W per attuatori 230Vac, ricevente radio 433,92MHz.

Control unit for controlling 230Vac actuators by remote control or wired button: 110/240Vac power supply, 3 wired inputs that can be set with step-by-step, dead man function or weather sensors, 4 outputs with a maximum power of 500W for 230Vac actuators, 433.92MHz radio receiver.

Codice / Code	MX00 AU 07 H 0W 00
Alimentazione / Power supply	110-240 Vac
Uscita / Output	4 x Max 500W Motori a 3 fili con finecorsa / 3 wires tubular motors
Funzione / Function	Apre/Stop/Chiude Open/Stop/Close
Ingressi / Input	3 input programmabili 3 programmable inputs
Trasmittitori Programmabili / Programmable Transmitters	30
Frequenza radio / Radio Frequency	433.920MHz ISM
Grado di protezione / Protection rating	IP20
Temperatura di funzionamento / Working Temperature	-20 +55 °C
Dimensioni / Dimensions	174x46x35mm

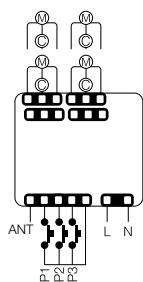

→ Smart home accessori

Smart home accessories



AF-850

Centrale per comandare attuatori 230Vac mediante app OneSMART, radiocomando, pulsante filare o comando vocale: alimentazione 110/240Vac, 3 ingressi filari impostabili con funzione passo-passo, uomo presente o sensori meteo, 4 uscite di potenza massima 500W per attuatori 230Vac, ricevente radio 433,92MHz, modulo WiFi integrato per il controllo remoto tramite App OneSmart e comando vocale.

Control unit for controlling 230Vac actuators via OneSMART app, remote control, wired button or voice command: 110/240Vac power supply, 3 wired inputs that can be set with step-by-step function, dead man or weather sensors, 4 outputs with a maximum power of 500W for 230Vac actuators, 433.92MHz radio receiver, integrated WiFi module for remote control via OneSmart App and voice command.

Codice / Code	MX00 AU 08 H 0W 00
Alimentazione / Power supply	110-240 Vac
Uscita / Output	4 x Max 500W Motori a 3 fili con finecorsa/ 3 wires tubular motors
Funzione / Function	Apri/Stop/Chiude Open/Stop/Close
Ingressi / Input	3 input programmabili 3 programmable inputs
Trasmettitori Programmabili / Programmable Transmitters	30
Frequenza radio / Radio Frequency	433.920MHz ISM
Wireless Smart	WiFi 2,4GHz
Controllo Smart remoto / Smart remote control	App OneSmart
Controllo Vocale / Voice commands	Google Home, Alexa Amazon
Grado di protezione / Protection rating	IP20
Temperatura di funzionamento / Working Temperature	-20 +55 °C
Dimensioni / Dimensions	174x46x35mm

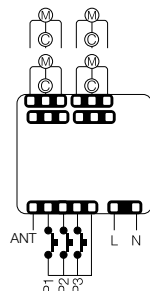

AF-860

Centrale di comando con funzionalità contatto pulito: alimentazione 12/24 Vac/dc, 2 uscite con contatto normalmente aperto, ricevente radio 433,92MHz, modulo WiFi integrato per il controllo remoto tramite App OneSmart e comando vocale, ingresso per finecorsa o spia cancello per controllare lo stato del dispositivo.

Control unit with dry contact function: 12/24 Vac/dc power supply, 2 outputs with normally open contact, 433.92MHz radio receiver, integrated WiFi module for remote control via OneSmart App and voice command, input for limit switch or signal light for checking the device status.

Codice / Code	MX00 AU 09 L 0W 00
Alimentazione / Power supply	12-24 Vac/dc
Uscita / Output	Due contatti NO max 1A (Funzione START) 2 NO contact max 1A (Function START)
Ingressi / Input	2 input settabili con funzione di "stato automazione" 2 programmable inputs with automation status function
Funzione / Function	Impulso / 1 Impulse
Trasmettitori Programmabili / Programmable Transmitters	30
Frequenza radio / Radio Frequency	433.920MHz ISM
Wireless Smart	WiFi 2,4GHz
Controllo Smart remoto / Smart remote control	App OneSmart
Controllo Vocale / Voice commands	Google Home, Alexa Amazon
Grado di protezione / Protection rating	IP20
Temperatura di funzionamento / Working Temperature	-20 +55 °C
Dimensioni / Dimensions	80x80x16

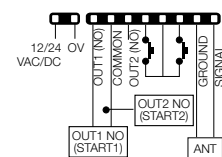



AF-870

Comando a muro radio 433.92MHz Rolling code:

Funzione apre-chiude-stop

up/down, apre-chiude-stop

Batteria CR2450.

433.92MHz radio Rolling code switch:

Open-close-stop function

up/down, open-close-stop

CR2450 battery.



AF-880

Radiocomando 1 canale 433,92 MHz Rolling code:

Funzione apre-stop-chiude-apertura parziale.

Batteria CR2230.

Supporto a parete incluso.

1-channel 433.92 MHz Rolling code remote control:

Open-stop-close-partial opening function.

CR2230 battery.

Wall mount included.



AF-890

Radiocomando 6 canali 433,92 MHz Rolling code:

Funzione apre-stop-chiude-apertura parziale.

Batteria CR2230.

Supporto a parete incluso.

6-channel remote control 433.92 MHz Rolling code:

Open-stop-close-partial opening function.

CR2230 battery.

Wall mount included.



→ Perché è importante il controllo del fumo e del calore

Why the control of smoke and heat is important



Nella maggior parte dei casi di incendio la causa principale di decessi nonché intossicazioni o bruciature è il soffocamento dovuto ai gas e fumi che non hanno modo di defluire all'esterno. La probabilità che questo succeda aumenta in considerazione del fatto che in uno stabile pieno di fumo le squadre di soccorso non sono messe nelle condizioni di poter intervenire in maniera rapida e tempestiva per far evacuare il personale all'interno e spegnere l'incendio.

In most cases of fire, the main cause of death, in addition to poisoning or burns is suffocation due to gases and fumes that have no way of flowing outside. The likelihood of this happening increases in consideration of the fact that in a smoke-filled building the rescue teams are not in a position to intervene quickly and promptly to evacuate the personnel inside and extinguish the fire.



Per questo motivo, dopo una fase iniziale di sostanziale sperimentazione è diventato necessario e spesso obbligatorio prevedere sistemi per il controllo del fumo e calore perfettamente in linea con tutte le disposizioni previste dalle normative di riferimento. Uno dei sistemi più efficaci ed utilizzati è il sistema naturale di evacuazione fumo e calore SENFC.

Anche nel caso in cui non ci sia la presenza di persone coinvolte nell'incendio, all'interno del locale la pronta evacuazione dei fumi limita i danni a merci e impianti.

For this reason, after an initial phase of substantial experimentation, it has become necessary and often mandatory to provide systems for controlling smoke and heat that are perfectly in line with all the provisions set forth in the reference regulations. One of the most effective and used systems is the natural smoke and heat evacuation system SENFC.

Even if there are no people involved in the fire, the prompt evacuation of fumes inside the room limits damage to goods and systems.

→ Definizioni principali

Main definitions

SEFC / SHEVS

Sistemi di evacuazione fumo e calore SEFC

Componenti selezionati congiuntamente per evacuare fumo e calore in modo da creare uno strato in sospensione di gas caldi al disopra di aria più fresca e pulita.

SHEVS smoke and heat evacuation systems

Jointly selected components to evacuate smoke and heat to create a suspended layer of hot gases above cooler, cleaner air.

EFC

Evacuatore naturale di fumo e calore automatico EFC

Dispositivo appositamente progettato per spostare fumo e gas caldi all'esterno di un fabbricato in caso di incendio.

EFC automatic natural smoke and heat evacuator

Device specially designed to move smoke and hot gases out of a building in case of fire.

AV

Superficie Geometrica "Av"

Superficie della sezione dell'evacuatore, misurata nel piano definito dalla superficie del fabbricato a contatto con la struttura dell'evacuatore. Non è fatta alcuna riduzione per controlli, lamelle o altre soluzioni.

Geometric Surface "Av"

Surface area of the vent section, facially measured defined by the surface of the building in contact with the vent structure. No reduction is made for controls, slats or other solutions.

Aa

Superficie utile di apertura "Aa"

Prodotto della superficie geometrica moltiplicata per il coefficiente di efflusso.

Useful opening area "Aa"

Product of the geometric surface multiplied by the coefficient of outflow.

Cv

Coefficiente di efflusso "Cv"

Rapporto fra la portata effettiva, misurata in condizioni specifiche, e la portata teorica attraverso il ventilatore (Cv).

Flow coefficient "Cv"

Ratio between the actual flow rate, measured under specific conditions, and the theoretical flow rate through the fan (Cv).



Molto spesso i sistemi di evacuazione fumo e calore (SHEVS) vengono associati alla sigla RWA che deriva dalla nomenclatura tedesca Rauch und Warm Abzug per definire questo tipo di sistemi

Very often smoke and heat evacuation systems (SHEVS) are associated with the acronym RWA which derives from the German nomenclature Rauch und Warm Abzug to define this type of system

→ Cos'è un evacuatore fumo e calore ENFC

What is an ENFC smoke and heat extractor



L'evacuatore naturale di fumo e calore (ENFC) è un elemento del sistema di evacuazione SENFC atto alla fuoriuscita di gas e fumi in caso di incendio. Viene posizionato nella parte superiore del compartimento a parete o nella copertura dello stabilimento. Una caratteristica principale e significativa degli evacuatori è la superficie utile di apertura "Aa" che caratterizza l'efficienza dell'evacuatore. Tale valore è ottenibile determinando il valore del coefficiente di efflusso Cv necessariamente mediante prova pratica su apposito impianto e relativi dispositivi in scala reale.

La superficie utile di apertura Aa infatti non è altro che la superficie geometrica dell'evacuatore moltiplicato per il coefficiente di efflusso Cv che viene estrapolato da i test stabiliti dalla normativa di riferimento [UNI EN 12101-2](#)

Per essere immesso sul mercato, l'Evacuatore Naturale di Fumo e Calore (ENFC) deve essere accompagnato da Dichiarazione di Prestazione e relativa marcatura CE secondo la norma armonizzata UNI EN 12101-2:2004 che contiene metodi e criteri per valutare le prestazioni degli ENFC in relazione alle loro caratteristiche essenziali.

Con la nuova serie MOWIN, Fratelli Comunello Spa è in grado di offrire una gamma completa di attuatori che hanno prestazioni elevate ottenute nel corso di test di qualifica di ENFC eseguiti da enti notificati. Questi risultati rendono gli attuatori particolarmente idonei per essere incorporati in ENFC e consentono di realizzare idonee aperture di smaltimento fumo e calore installandoli su serramenti esistenti. La loro affidabilità permette inoltre di svolgere l'ulteriore funzione di ventilazione naturale giornaliera.

The natural smoke and heat extractor (ENFC) is an element of the SENFC evacuation system suitable for the escape of gas and fumes in the event of a fire. It is placed in the upper part of the wall compartment or in the roof of the establishment. A main and significant feature of the evacuators is the useful opening surface "Aa" which characterizes the efficiency of the evacuator. This value can be obtained by determining the value of the Cv outflow coefficient necessarily by means of a practical test on a specific plant and relative devices on a real scale.

In fact, the useful opening surface Aa is nothing more than the geometric surface of the vent multiplied by the outflow coefficient Cv which is extrapolated from the tests established by the reference standard [UNI EN 12101-2](#)

To be placed on the market, the Natural Smoke and Heat Evacuator (SNF) must be accompanied by the Declaration of Performance and relative CE marking according to the harmonized standard UNI EN 12101-2:2004 which contains methods and criteria for evaluating the performance of SNF in relation to their essential characteristics.

With the new MOWIN series, Fratelli Comunello Spa is able to offer a complete range of actuators which have high performances obtained in the course of ENFC qualification tests carried out by notified bodies. These results make the actuators particularly suitable for incorporation in ENFC and allow for the creation of suitable smoke and heat dissipation openings by installing them on existing frames. Their reliability also allows them to perform the dual function of natural daily ventilation.

→ Sistema di evacuazione fumo e calore SEFC

Smoke and Heat Evacuation system SHEVS



Il controllo del fumo e calore è una misura determinante e fondamentale per la sicurezza antincendio e assicurare la salvaguardia sia delle persone che dei beni comuni in caso di incendio. Esistono 3 tipologie di sistemi per il controllo di fumo e calore previsti dalle normative vigenti:

The control of smoke and heat is a decisive and fundamental measure for fire prevention and to ensure the protection of both people and common property in the event of a fire. There are 3 types of smoke and heat control systems required by current regulations:

1 Sistemi di Evacuazione di Fumo e Calore SEFC

Creazione di uno strato libero da fumo su cui galleggia uno strato di fumo.

Smoke and Heat Evacuation Systems, SHEVS

Creation of a smoke-free layer on which a layer of smoke floats.

2 Sistemi di ventilazione del fumo

Espulsione e/o smaltimento di fumo e calore dal fabbricato o parte di esso.

Smoke ventilation systems

Expulsion and/or disposal of smoke and heat from the building or part of it.

3 Sistemi a differenza di pressione

Pressure differential systems

Strato "X" libero dai fumi grazie alle aperture e agli evacuatori
 Layer "X" free from fumes thanks to the openings and vents



L'obiettivo principale di un sistema di evacuazione del fumo e calore è quello di creare, in caso di incendio, uno strato libero da fumi alto almeno 2.5 metri che consenta l'esodo in sicurezza degli occupanti dall'edificio e favorisca le operazioni da parte delle squadre di soccorso.

Essendo la temperatura di gas e fumi maggiore rispetto alla temperatura dell'aria ambiente, in caso di incendio, il fumo tende ad occupare la parte superiore del compartimento.

Il sistema naturale di evacuazione SENFC sfrutta questo principio e, grazie alle idonee aperture per l'entrata di aria fresca e agli evacuatori (entrambi opportunamente dimensionati) che favoriscono la fuoriuscita dei fumi, si riesce a creare uno strato "X" libero da fumi.

La superficie utile di apertura (A_a) rispetta i test stabiliti dalla norma armonizzata di riferimento **UNI EN 12101**. $A_a = A_v \times C_v$

The main objective of a smoke and heat evacuation system is to create, in the event of a fire, a smoke-free layer at least 2.5 meters high which allows people to escape from the establishment and favors rescue team operations .

Since the gas and fume temperature is higher than the ambient air temperature, in the event of a fire, the smoke tends to occupy the upper part of the compartment.

The SENFC natural evacuation system exploits this principle and, thanks to the suitable openings for the entry of fresh air and the vents (both suitably sized) which favor the escape of the fumes, it is possible to create a "X" layer free from fumes.

*The useful opening surface (A_a) complies with the tests established by the reference harmonized standard **UNI EN 12101**. $A_a = A_v \times C_v$*

→ Impianti di evacuazione del fumo e del calore

Smoke and heat evacuation systems



TEST secondo normativa 12101-2:

Gli attuatori Comunello LIWIN L40 ed L40 SLIM, (nelle versioni a 24 VDC), opportunamente installati in evacuatori fumo e calore hanno superato i test di resistenza al calore presso l'ente notificato secondo la normativa di riferimento UNI EN 12101-2.

Gli attuatori sono stati sottoposti a prova, in conformità l'appendice G della UNI EN 12101-2, alla temperatura di 300°C.

Le caratteristiche di questi attuatori sono quindi particolarmente adatte per un utilizzo con evacuatori fumo e calore che devono essere certificati.

TEST secondo normativa 12101-2:

The Comunello LIWIN L40 and L40 SLIM actuators (in the 24 VDC versions), suitably installed in smoke and heat extractors, have passed the heat resistance tests at a notified body according to the reference standard UNI EN 12101-2.

The actuators have been tested, in compliance with appendix G of UNI EN 12101-2, at a temperature of 300°C.

The characteristics of these actuators are therefore particularly suitable for use with smoke and heat extractors which must be certified.

Sistema di evacuazione naturale fumo e calore

Natural smoke and heat evacuation system



Barriere al fumo
Smoke barriers

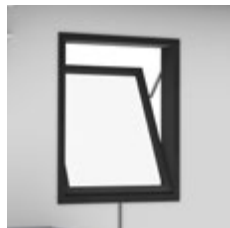

Evacuatori naturali di fumo e calore, aperture per l'afflusso di aria
Natural smoke and heat evacuators, openings for the inflow of air

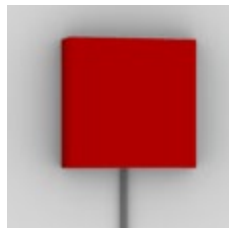

Quadri comando e controllo
Command and control panels



Linee di collegamento
Connecting lines

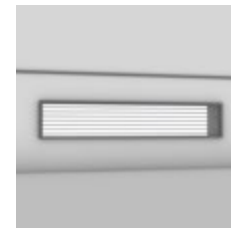

Ingresso aria
Air inlet

Un sistema completo di evacuazione naturale fumo e calore SENFC è composto dai seguenti componenti:

Serbatoio di fumo (1600 m2)
Evacuatori Naturali di Fumo e Calore (ENFC)
Barriere al fumo
Aperture per l'afflusso di aria fresca
Alimentazioni
Quadri comando e controllo
Linee di collegamento

A complete SENFC natural smoke and heat evacuation system consists of the following components:

Smoke tank (1600 m2)
Natural Smoke and Heat Evacuators (NFC)
Smoke barriers
Openings for the inflow of fresh air
Power supplies
Command and control panels
Connecting lines

Test affidabilità:

Gli attuatori STAR 25, STAR 30, LIWIN L35 SLIM, L40, L40 SLIM E L20 INSERT sono stati sottoposti ai più severi test di affidabilità nelle varie applicazioni dichiarate superando i 10 000 cicli a carico massimo dichiarato. I test di ciclica a massimo carico sono stati effettuati a temperatura ambiente.

Reliability tests:

The STAR 25, STAR 30, LIWIN L35 SLIM, L40, L40 SLIM AND L20 INSERT actuators have been subjected to the strictest reliability tests in the various declared applications exceeding 10,000 cycles at maximum declared load. The cycling tests at maximum load were carried out at room temperature.

→ Nuova elettronica RWA

RWA new electronics

Le centrali CU RWA sono certificate secondo DIN EN 12101-10 in grado di gestire sistemi di evacuazione e calore e ventilazione naturale con attuatori Comunello e relativi accessori. Può essere inoltre interfacciata alle centraline antincendio.

The CU RWA control units are certified according to DIN EN 12101-10 capable of managing evacuation and heat and natural ventilation systems with Comunello actuators and related accessories. It can also be interfaced with fire control units.



Caratteristiche principali

Main features

4 uscite per il collegamento di attuatori 24Vdc.

4 outputs for the connection of 24V actuators.

Omologato VdS secondo le direttive VdS 2581 e VdS 2593.*

*VdS approved according to VdS 2581 and VdS 2593 guidelines.**

Alimentazione interna certificata secondo DIN EN 12101-10.

Internal power supply certified according to DIN EN 12101-10.

Centralina testata secondo la ISO 21927-9**

*Control unit tested according to ISO 21927-9***

Rivelatore d'incendio automatico.

Automatic fire detector.

Pulsante manuale di emergenza con indicatori LED di funzionamento corretto, allarme, malfunzionamento e ripristino.

Emergency manual call point with LED indicators for correct operation, alarm, malfunction and reset.

Possibilità di collegare una centrale rilevamento incendio.

Possibility of connecting a fire detection control unit.

Reset dell'allarme (mediante il pulsante di emergenza o direttamente dalla centralina).

Alarm reset (by means of the emergency button or directly from the control unit).

Chiusura automatica dopo il reset di un allarme (funzione impostabile).

Automatic closing after the reset of an alarm (settable function).

Allarme in caso di malfunzionamento di una linea di segnale (rilevatore fumo / pulsante di emergenza / centrale antincendio).

Alarm in case of malfunction of a signal line (smoke detector / emergency button / fire control panel).

I comandi automatici, esclusi gli allarmi, vengono disabilitati (funzione impostabile).

The automatic commands, excluding the alarms, are disabled (settable function).

Allarme termico: allarme per superamento della temperatura di 70°C all'interno della centralina.

Thermal alarm: alarm for exceeding the temperature of 70 °C inside the control unit.

Possibilità di collegare pulsanti per la ventilazione naturale.

Possibility to connect buttons for natural ventilation.

Posizione di ventilazione regolabile.

Adjustable ventilation position.

Possibilità di collegare rilevatori vento e pioggia esterni.

Possibility to connect external wind and rain detectors.

Allarme incendio e malfunzionamento vengono visualizzati mediante led dedicati nel pulsante di emergenza.

Fire alarm and malfunction are displayed by dedicated LEDs in the emergency button.

Display di servizio interno che mostra informazioni dettagliate sullo stato per l'installazione e manutenzione.

Internal service display showing detailed status information for installation and maintenance.

Morsetti estraibili (esclusa l'uscita per gli attuatori).

Removable terminals (excluding the output for the actuators).

La centralina è fissata all'interno del box in acciaio verniciato.

The control unit is fixed inside the painted steel box.

Batterie tampone incluse.

Backup batteries included.

* CU RWA 4A/CU RWA 8A

** CU RWA 40A

Specifiche tecniche

Technical specifications	CU RWA 4A	CU RWA 8A	CU RWA 40A
Codice / Code	MX 00 AU 4A L 0W 00	MX 00 AU 8A L 0W 00	MX 00 AU 40L 0W 00
Alimentazione di rete / Mains power	230 VAC		
Consumo di corrente / Current consumption	0,7 A / 230 VAC	1,1 A / 230 VAC	5,0 A / 230 VAC
Corrente in uscita / Outgoing current	4 A (24 V- / 96 W)	8 A (24 V- / 192 W)	40 A (24 V- / 960 W)
Batteria / Battery	2,0 Ah (includere)	7,0 Ah (includere)	12V / 17,0Ah (non includere/not included)
Dimensioni / Dimensions	330 x 330 x 110	400 x 400 x 125	430 x 525 x 185 mm
Gruppi ventilazione / Ventilation groups	1	1	1-4
Gruppi evacuazione fumo e calore / Smoke and heat evacuation groups	1	1	1-2
Grado di protezione / Degree of protection	IP 30	IP 40	IP 30
Regolazione posizione ventilazione / Ventilation position adjustment	Sì / Yes	Sì / Yes	Sì / Yes

	Description	Product code
	Centrale RWA 40A CU RWA 40A	MX00AU40LOW00
	Centrale RWA 8A CU RWA 8A	MX00 AU 8A L 0W 00
	Centrale RWA 40A CU RWA 40A	MX00AU40LOW00
	Rilevatore di pioggia Rain sensor	MX00 AR 01 N 0G 00
	Pulsante di emergenza Emergency button	MX00 EB 00 L 0A 00

	Description	Product code
	Rilevatore fumo Smoke detector	MX00 SD 00 L 0W 00
	Rilevatore calore Heat detector	MX00 HD 00 L 0W 00
	Rilevatore pioggia trasparente Transparent rain sensor	MX00 AR 01 N 0T 00
	Rilevatore vento per centrale RWA Wind sensor for RWA control unit	MX00 AR 05 L 0W 00
	Interfaccia rilevatore vento per centrale RWA Wind sensor interface for RWA control unit	MX00 AU 03 N 0B 00



1

LIWIN L40



p. 50

Attuatore a catena in alluminio pressofuso per apertura e chiusura di finestre in legno, PVC, alluminio e acciaio. Adatto ad aperture a vasistas, sporgere, battente, apertura parallela, shed, lucernai e cupolini.

Chain actuator in die-cast aluminum for opening and closing windows in wood, PVC, aluminum and steel. Suitable for bottom-hung, protruding, swing, parallel opening, shed, skylights and cupolas.

RWA 24 V
NV 24 / 110 / 230 V



LIWIN L40 SLIM - 350



p. 60

Attuatore a catena in alluminio estruso per apertura e chiusura di finestre in legno, PVC, alluminio e acciaio. Adatto ad aperture a vasistas, sporgere, battente, apertura parallela, shed, lucernai e cupolini.

Chain actuator in extruded aluminum for opening and closing wooden, PVC, aluminum and steel windows. Suitable for bottom-hung, protruding, swing, parallel opening, shed, skylights and cupolas.

RWA 24 V
NV 24 / 110 / 230 V



LIWIN L40 SLIM - 600



p. 70

Attuatore a catena in alluminio estruso per apertura e chiusura di finestre in legno, PVC, alluminio e acciaio. Adatto ad aperture a vasistas, sporgere, battente e aperture parallele.

Chain actuator in extruded aluminium for opening and closing wooden, PVC, aluminum and steel windows. Suitable for bottom-hung, projecting, casement and parallel openings.

RWA 24 V
NV 24 / 110 / 230 V



LIWIN L40 SLIM - 800**LIWIN L40 SLIM - 1000****BLOCK**

p. 80

Attuatore a catena in alluminio estruso per apertura e chiusura di finestre in legno, PVC, alluminio e acciaio. Adatto ad aperture a vasistas, sporgere, battente, apertura parallela.

Chain actuator in extruded aluminium for opening and closing wooden, PVC, aluminum and steel windows. Suitable for bottom-hung, protruding, hinged, parallel openings.

p. 90

Attuatore a catena in alluminio estruso per apertura e chiusura di finestre in legno, PVC, alluminio e acciaio. Adatto ad aperture a vasistas, sporgere, battente, apertura parallela.

Chain actuator in extruded aluminium for opening and closing windows in wood, PVC, aluminum and steel. Suitable for bottom-hung, protruding, hinged, parallel openings.

p. 100

Serratura elettromeccanica in alluminio pressofuso per la movimentazione della ferramenta interna di una finestra.

Electromechanical lock in die-cast aluminum for movement of the internal hardware of a window.

RWA 24 V
NV 24 / 110 / 230 V



RWA 24 V
NV 24 / 110 / 230 V



RWA 24 V
NV 24 V



LIWIN L40

LIWIN L40 - Wi-Fi



Attuatore elettromeccanico in alluminio pressofuso modello LIWIN L40 con catena a doppia maglia e spessore maggiorato. Grazie alle dimensioni complessivamente ridotte ed in particolare allo spessore di soli 30 mm LIWIN L40 è particolarmente adatto ad installazioni su spazi ristretti. La nuova tecnologia Wi-Fi, oltre a dare la possibilità di regolare parametri come lunghezza della catena e velocità di apertura/chiusura consente la sincronizzazione fino a 8 attuatori da poter installare in un'unica finestra di grandi dimensioni o su sistemi in cui è necessaria una forza elevata. La nuova app Comunello Mowin consente inoltre di fare una diagnostica real time degli attuatori molto utile per risalire alle cause di eventuali anomalie.

L'attuatore LIWIN L40 ha superato tutti i test di resistenza al calore previsti dalla normativa EN 12101-2 per la certificazione di evacuatori fumo e calore ed è quindi in grado di soddisfare i relativi requisiti necessari per essere implementato nei sistemi RWA.

Electromechanical actuator in die-cast aluminum model LIWIN L40 with double link chain and increased thickness. Thanks to the overall reduced dimensions and in particular to the thickness of only 30 mm, LIWIN L40 is particularly suitable for installations in confined spaces. The new Wi-Fi technology, in addition to making it possible to adjust parameters such as chain length and opening/closing speed, allows synchronization of up to 8 actuators that can be installed in a single large window or on systems where a high force is necessary. The new Comunello Mowin app also allows real-time diagnostics of the actuators, which is very useful for tracing the causes of any anomalies.

The LIWIN L40 actuator has passed all the heat resistance tests required by the EN 12101-2 standard for the certification of smoke and heat extractors and is therefore able to meet the related requirements necessary to be implemented in RWA systems.





LIWIN L40

LIWIN L40 - Wi-Fi



Attuatore a catena per apertura e chiusura di finestre in legno, PVC, alluminio e acciaio. Adatto ad aperture a vasistas, sporgere, battente, apertura parallela, shed, lucernai e cupolini.

Chain actuator for opening and closing wooden, PVC, aluminum and steel windows. Suitable for bottom-hung, projecting, swing, parallel openings, sheds, skylights and small domes.





LIWIN L40

LIWIN L40 - Wi-Fi

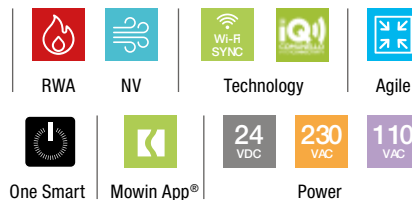

Trimmer

Posizione M: Stato attuatore SLAVE
 Posizioni 1-2-3-4: Impostazione corsa catena: 200-300-400-500 mm. La corsa dell'attuatore può essere regolata millimetricamente fino a 500 mm mediante Mowin App.
 Posizione A: Wi-Fi attivo - MASTER.

Trimmer

*Position M: Slave actuator status
 Positions 1-2-3-4: Chain stroke setting: 200-300-400-500 mm. The stroke of the actuator can be adjusted in millimeters up to 500 mm using the Mowin App.
 Position A: WiFi activated - MASTER.*

 **Vasistas**
Bottom hung



 **Sporgere**
Top hung



Caratteristiche principali

Main features

Forza

Force

Gli attuatori della serie LIWIN L40 hanno una forza di spinta e trazione massima pari a 400N. Grazie alla funzione di sincronizzazione è possibile ottenere una forza massima totale fino a 2240N.

The LIWIN L40 series actuators have a maximum push and pull force of 400N. Thanks to the synchronization function it is possible to obtain a total maximum force up to 2240N.

QRCode Sync

QRCode Sync

Sincronizzazione di più attuatori, Regolazione parametri, Registrazione e Diagnostica in tempo reale tramite una semplice scansione del QRCode.

Synchronization of multiple actuators, Parameter adjustment, Recording and Diagnostics in real time by simply scanning the QRCode.

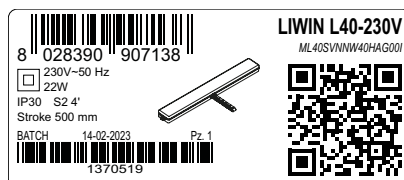

Resistenza

Resistance

L'involucro e le staffe in alluminio pressofuso garantiscono un'elevata resistenza anche in ambienti particolarmente difficili; l'attuatore ha superato i test di resistenza al calore previsti dalla normativa EN12101-2

The die-cast aluminum casing and brackets guarantee high resistance even in particularly difficult environments; the actuator has passed the heat resistance tests required by the EN12101-2 standard.

Caratteristiche tecniche / Technical data sheet

	LIWIN L40		LIWIN L40 Wi-Fi	
Forza trazione / <i>Traction force</i>	400 N*	400 N*	400 N*	400 N*
Forza spinta / <i>Thrust force</i>	400 N*	400 N*	400 N*	400 N*
Alimentazione / <i>Power supply</i>	110/230 V	24 V	110/230 V	24 V
Frequenza / <i>Frequency</i>	50/60 hz	-	50/60 hz	-
Tipo di servizio / <i>Type of service</i>	3 min ON 7 min OFF	3 min ON 7 min OFF	3 min ON 7 min OFF	3 min ON 7 min OFF
Velocità a vuoto / <i>Unloaded stroke speed</i>	11 mm/s	11 mm/s	11mm/s	11 mm/s
Corse disponibili / <i>Strokes available</i>	200 - 300 - 400 - 500**	200 - 300 - 400 - 500	200 - 300 - 400 - 500** Regolazione millimetrica con app Mowin <i>Millimetric adjustment with Mowin app</i>	200 - 300 - 400 - 500 Regolazione millimetrica con app Mowin <i>Millimetric adjustment with Mowin app</i>
Temperatura di funzionamento / <i>Operating temperature</i>	-5°c + 50°c	-5°c + 50°c	-5°c + 50°c	-5°c + 50°c
Grado di protezione IP / <i>IP protection class</i>	30	30	30	30
Soft START / Soft STOP	Si / Yes	Si / Yes	Si / Yes	Si / Yes
Assorbimento corrente / <i>Current draw</i>	0,4 A	1 A	0,4 A	2 A
Potenza assorbita / <i>Power draw</i>	42W	24 W	42 W	24 W
Rilevamento ostacolo / <i>Obstacle detection</i>	Assorbimento di corrente <i>Current draw</i>	Assorbimento di corrente <i>Current draw</i>	Assorbimento di corrente <i>Current draw</i>	Assorbimento di corrente <i>Current draw</i>
Collegamento in parallelo / <i>Connection in parallel</i>	Si / Yes Max 30 attuatori <i>Max 30 actuators</i>	Si / Yes Max 30 attuatori <i>Max 30 actuators</i>	Si / Yes Max 30 attuatori <i>Max 30 actuators</i>	Si / Yes Max 30 attuatori <i>Max 30 actuators</i>
Sincronizzazione / <i>Synchronisation</i>	No	No	Fino a 8 attuatori <i>Up to 8 actuators</i>	Fino a 8 attuatori <i>Up to 8 actuators</i>
Dimensioni / <i>Dimensions</i>	30 x 58 x 498 mm	30 x 58 x 498 mm	30 x 58 x 498 mm	30 x 58 x 498 mm
Finecorsa in apertura / <i>Open limit switch</i>	Encoder	Encoder	Encoder	Encoder
Finecorsa in chiusura / <i>Closed limit switch</i>	Amperometrica <i>Amperometric</i>	Amperometrica <i>Amperometric</i>	Amperometrica <i>Amperometric</i>	Amperometrica <i>Amperometric</i>
Peso attuatore / <i>Actuator weight</i>	1,85 Kg	1,85 Kg	1,85 Kg	1,85 Kg

*Vedi grafici portate pag 58-59 / See actuators graph pag. 58-59

**Escluso codice L40 C Z / L40 WiFi C Z : 100-200-300-380mm / Excluding L40 C Z / L40 WiFi C Z : 100-200-300-380mm

Catena Chain

La qualità elevata e la robustezza della catena inox a doppia maglia garantiscono la trasmissione della forza massima sia in trazione che in spinta. È disponibile anche la versione con catena zincata.

The high quality and sturdiness of the double link stainless steel chain guarantee the transmission of the maximum force both in traction and in thrust. The version with zinc plated chain is also available.

IQ Interconnectivity IQ Interconnectivity

L'interconnettività IQ è un innovativo sistema di comunicazione wireless. Grazie al dispositivo Wi-Fi posto all'interno del motore è possibile connettersi con l'app MOWIN per una completa configurazione degli attuatori e garantisce una perfetta sincronizzazione tra più attuatori installati sulla stessa finestra.

IQ interconnectivity is an innovative wireless communication system. Thanks to the Wi-Fi device placed inside the motor, it allows you to connect with the MOWIN app for complete configuration of the actuators and guarantee perfect synchronization between multiple actuators installed on the same window.

Diagnostica Diagnostics

La Mowin App consente sia la registrazione delle ultime manovre con le eventuali anomalie segnalate, sia di effettuare una diagnostica in tempo reale per individuare eventuali errori di malfunzionamento.

L'attuatore è anche dotato di un led in grado di segnalare se ci sono eventuali anomalie.

The Mowin App allows both the recording of the last manoeuvres with any reported anomalies and real-time diagnostics to identify any malfunction errors. The actuator is also equipped with a led able to signal if there are any anomalies.

LIWIN L40

LIWIN L40 - Wi-Fi



Configurazione dell'attuatore

Actuator configuration

Sporgere Top hung

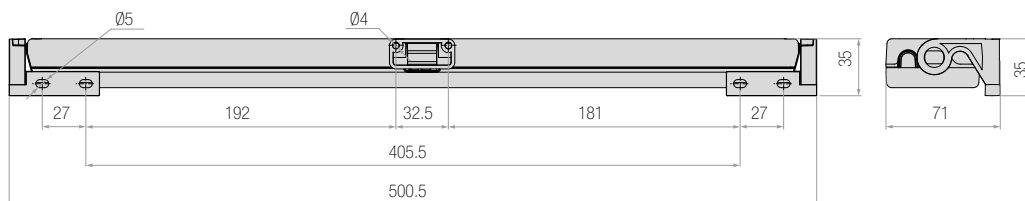

L40 - Angolo di apertura anta a sporgere

L40 - Top hung opening angle

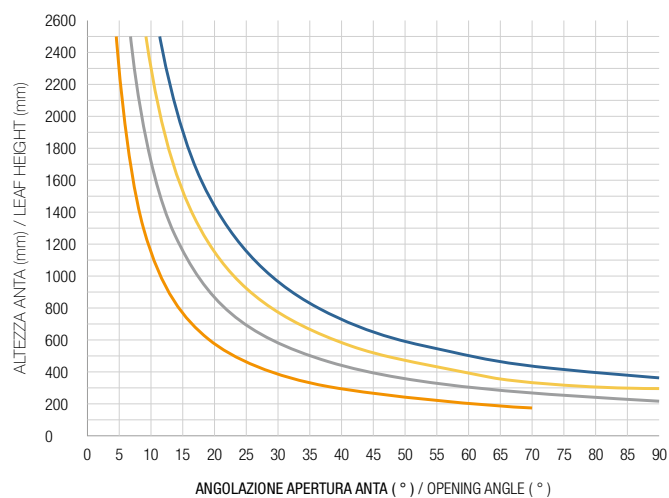

CORSA / STROKE — 200 mm — 300 mm — 400 mm — 500 mm

L40 - Portate attuatori a sporgere e cupola

L40 - Actuator force - top hung and dome

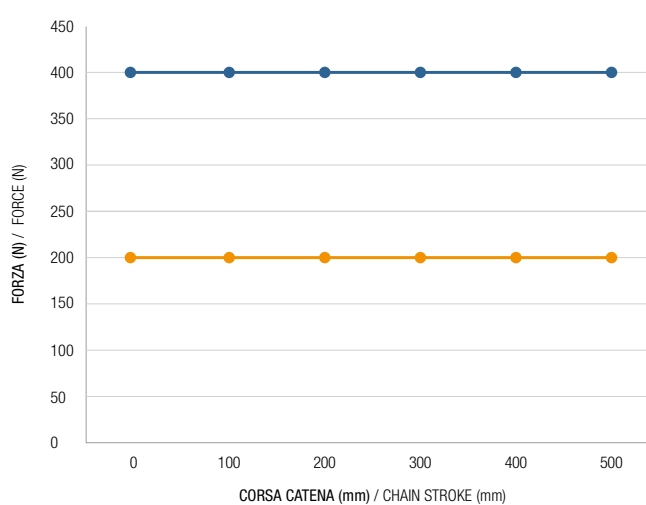

—●— SPORGERE / TOP HUNG OUTWARD OPENING —●— CUPOLA / DOME

I valori indicati nei grafici sono da considerarsi indicativi e non considerano eventuali deformazioni dovute a fattori esterni.
The values indicated in the graphs are to be considered indicative and do not consider any deformations due to external factors.

Per scegliere l'attuatore Comunello Mowin più adatto, è necessario calcolare la FORZA (F) necessaria a sostenere il movimento della finestra. Il tipo di attuatore va selezionato considerando la combinazione tra la dimensione di BASE del serramento e la forza calcolata (N).

Per ante con BASE superiore a 1.5 metri, se il serramento è sufficientemente rigido, consigliamo l'installazione di sistemi sincronizzati come illustrato nel paragrafo Sincronizzazione di p.28.

In order to choose the most suitable Comunello Mowin actuator, you have to calculate the necessary FORCE (F) to sustain the window movement. Choose the actuator type in accordance with the CALCULATED FORCE (N) and the FRAME DIMENSION.

For leaves with a BASE greater than 1.5 metres, if the window is sufficiently rigid, we recommend the installation of synchronized systems as illustrated in the Synchronization paragraph on p.28.



Vasistas
Bottom hung

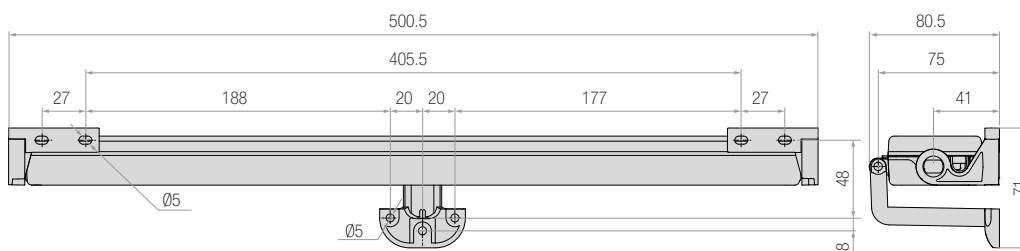

L40 - Angolo di apertura anta vasistas
L40 - Bottom hung opening angle

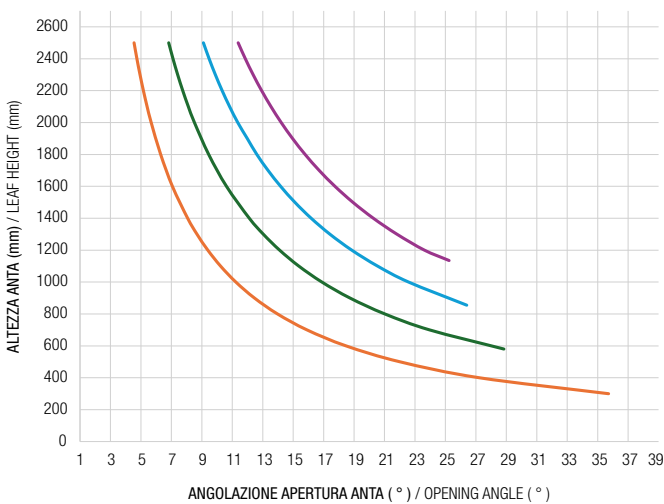

L40 - Portate attuatori vasistas
L40 - Actuator force - bottom hung

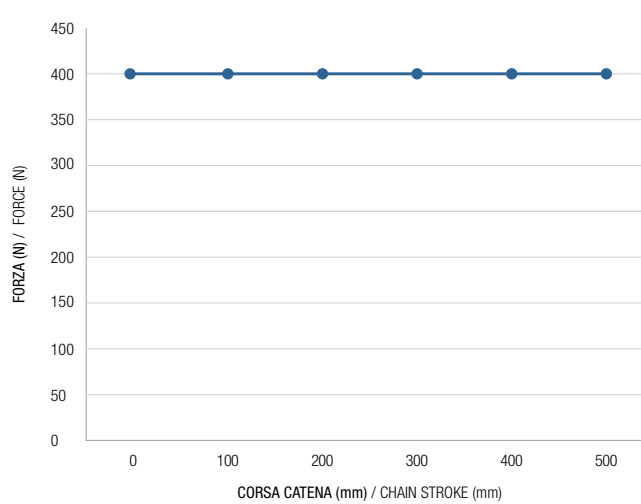

I valori indicati nei grafici sono da considerarsi indicativi e non considerano eventuali deformazioni dovute a fattori esterni.
The values indicated in the graphs are to be considered indicative and do not consider any deformations due to external factors.

Formule per il calcolo della forza necessaria a movimentare il serramento *Formulas for calculating the force necessary to move the window*

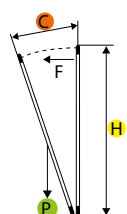

$$\frac{C \div H}{F} \times \frac{P \div 2}{N} = F \text{ Kg}$$

$$F \text{ (Kg)} \times 9,8 = \mathbf{N \text{ (N)}}$$

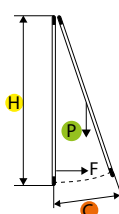

$$\frac{C \div H}{F} \times \frac{P \div 2}{N} = F \text{ Kg}$$

$$F \text{ (Kg)} \times 9,8 = \mathbf{N \text{ (N)}}$$

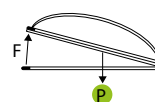

$$\frac{P}{2} = F \text{ Kg}$$

$$F \text{ (Kg)} \times 9,8 = \mathbf{N \text{ (N)}}$$

F = Forza necessaria
Necessary Force (Kg)

C = Corsa di apertura
Opening stroke (mm)

H = Altezza serramento
Window height (mm)

P = Peso serramento
Window weight (Kg)

LIWIN L40

LIWIN L40 - Wi-Fi





Articolo	Commercial code	Product code	Push / pull*	Strokes	Color	Power supply	Weight	Pcs
LIWIN L40	L40 RWA	ML40 S RW NW 50L AG00 I	400 N	200 - 300 - 400 - 500 mm	Grigio / Grey	24VDC	1,85 kg	1
LIWIN L40	L40 RWA	ML40 S RW NW 50L AB00 I	400 N	200 - 300 - 400 - 500 mm	Nero / Black	24VDC	1,85 kg	1
LIWIN L40	L40 RWA	ML40 S RW NW 50L AW00 I	400 N	200 - 300 - 400 - 500 mm	Bianco / White	24VDC	1,85 kg	1
LIWIN L40 Wi-Fi	L40 RWA-WF	ML40 S RW WF 50L AG00 I	400 N	200 - 300 - 400 - 500 mm	Grigio / Grey	24VDC	1,85 kg	1
LIWIN L40 Wi-Fi	L40 RWA-WF	ML40 S RW WF 50L AB00 I	400 N	200 - 300 - 400 - 500 mm	Nero / Black	24VDC	1,85 kg	1
LIWIN L40 Wi-Fi	L40 RWA-WF	ML40 S RW WF 50L AW00 I	400 N	200 - 300 - 400 - 500 mm	Bianco / White	24VDC	1,85 kg	1

*Vedi grafici portate attuatori p.58-59 / *See actuator flow charts p.58-59

Article	Commercial code	Product code	Push / pull*	Strokes	Color	Power supply	Weight	Pcs
LIWIN L40	L40-230V	ML40 S VN NW 50H AG00 I	400 N	200 - 300 - 400 - 500 mm	Grigio / Grey	110/230VAC	1,85 kg	1
LIWIN L40	L40-230V	ML40 S VN NW 50H AB00 I	400 N	200 - 300 - 400 - 500 mm	Nero / Black	110/230VAC	1,85 kg	1
LIWIN L40	L40-230V	ML40 S VN NW 50H AW00 I	400 N	200 - 300 - 400 - 500 mm	Bianco / White	110/230VAC	1,85 kg	1
LIWIN L40 C Z**	L40-230V C Z	ML40 S VN NW 40H AG00 Z	400 N	100 - 200 - 300 - 380 mm	Grigio / Grey	110/230VAC	1,85 kg	1
LIWIN L40 Wi-Fi	L40-230V-WF	ML40 S VN WF 50H AG00 I	400 N	200 - 300 - 400 - 500 mm	Grigio / Grey	110/230VAC	1,85 kg	1
LIWIN L40 Wi-Fi	L40-230V-WF	ML40 S VN WF 50H AB00 I	400 N	200 - 300 - 400 - 500 mm	Nero / Black	110/230VAC	1,85 kg	1
LIWIN L40 Wi-Fi	L40-230V-WF	ML40 S VN WF 50H AW00 I	400 N	200 - 300 - 400 - 500 mm	Bianco / White	110/230VAC	1,85 kg	1
LIWIN L40 Wi-Fi C Z**	L40-230V C Z-WF	ML40 S VN WF 40H AG00 Z	400 N	100 - 200 - 300 - 380 mm	Grigio / Grey	110/230VAC	1,85 kg	1

*Vedi grafici portate attuatori p.58-59 / *See actuators graph p.58-59

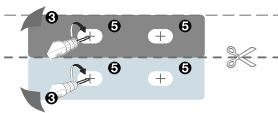
**Versione con catena zincata / **Version with zinc plated chain

La confezione contiene - Box contains:				
	Attuatore (staffe escluse) Actuator (brackets excluded)		Dima per l'installazione Mounting template	Manuale d'uso User manual
				



LIWIN L40 Slim - 350

LIWIN L40 Slim - 350 Wi-Fi



Attuatore elettromeccanico in alluminio estruso modello LIWIN L40 Slim - 350 con catena a doppia maglia e spessore maggiorato. Grazie alle dimensioni complessivamente ridotte ed in particolare allo spessore di soli 26 mm LIWIN L40 Slim - 350 è particolarmente adatto ad installazioni in spazi ristretti. La nuova tecnologia Wi-Fi, oltre a dare la possibilità di regolare parametri come lunghezza della catena e velocità di apertura/chiusura consente la sincronizzazione fino a 8 attuatori da poter installare in un'unica finestra di grandi dimensioni o su sistemi in cui è necessaria una forza elevata.

La nuova Mowin App consente inoltre di fare una diagnostica real time degli attuatori molto utile per risalire alle cause di eventuali anomalie.

L'attuatore LIWIN L40 Slim - 350 ha superato tutti i test di resistenza al calore previsti dalla normativa EN 12101-2 per la certificazione di evacuatori fumo e calore ed è quindi in grado di soddisfare i relativi requisiti necessari per essere implementato nei sistemi RWA.

Electromechanical actuator in extruded aluminium model LIWIN L40 Slim - 350 with double link chain and increased thickness. Thanks to the overall reduced dimensions and in particular to the thickness of only 26 mm LIWIN L40 Slim - 350 is particularly suitable for installations in confined spaces. The new Wi-Fi technology, in addition to making it possible to adjust parameters such as chain length and opening/closing speed, allows synchronization of up to 8 actuators that can be installed in a single large window or on systems where a high force is necessary. The new Mowin App also allows real-time diagnostics of the actuators, which is very useful for tracing the causes of any anomalies.

The LIWIN L40 Slim - 350 actuator has passed all the heat resistance tests required by the EN 12101-2 standard for the certification of smoke and heat extractors and is therefore able to meet the related requirements necessary to be implemented in RWA systems.





LIWIN L40 Slim - 350

LIWIN L40 Slim - 350 Wi-Fi



Attuatore a catena per apertura e chiusura di finestre in legno, PVC, alluminio e acciaio. Adatto ad aperture a vasistas, sporgere, battente, apertura parallela, shed, lucernai e cupolini.

Chain actuator for opening and closing wooden, PVC, aluminum and steel windows. Suitable for bottom-hung, projecting, swing, parallel openings, sheds, skylights and small domes.

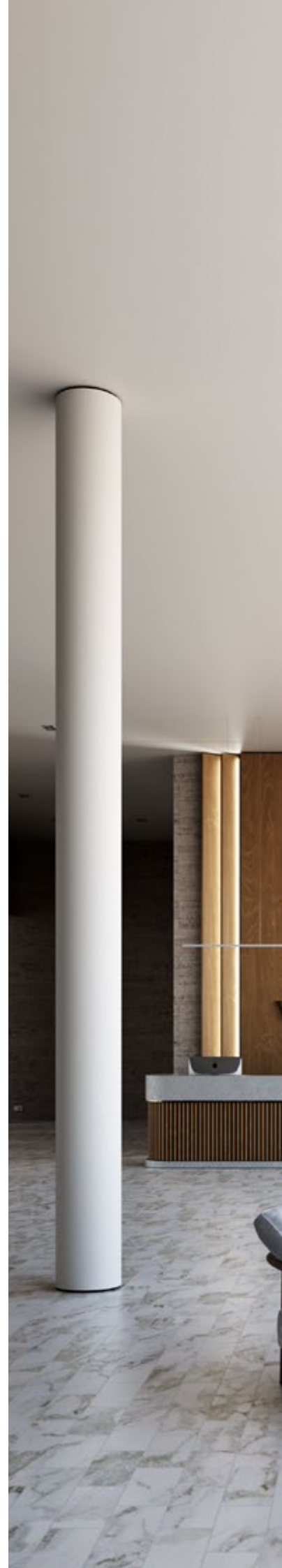



LIWIN L40 Slim - 350

LIWIN L40 Slim - 350 Wi-Fi

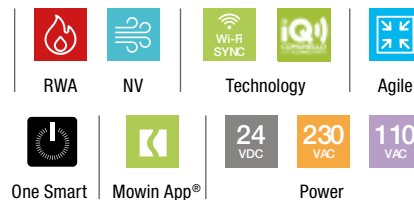

Trimmer

Posizione M: Stato attuatore SLAVE
Posizioni 1-2-3-4: Impostazione corsa catena: 200-250-300-350 mm. La corsa dell'attuatore può essere regolata millimetricamente fino a 350 mm mediante Mowin App.
Posizione A: Wi-Fi attivo - MASTER.

Trimmer

Position M: Slave actuator status
Positions 1-2-3-4: Chain stroke setting: 200-250-300-350 mm. The stroke of the actuator can be adjusted in millimeters up to 350 mm using the Mowin App.
Position A: WiFi activated - MASTER

 **Vasistas**
Bottom hung



 **Sporgere**
Top hung



Caratteristiche principali

Main features

Forza

Force

Gli attuatori della serie LIWIN L40 Slim hanno una forza di spinta e trazione massima pari a 400N. Grazie alla funzione di sincronizzazione è possibile ottenere una forza massima totale fino a 2240N.

The LIWIN L40 series actuators have a maximum push and pull force of 400N. Thanks to the synchronization function it is possible to obtain a total maximum force up to 2240N.

QRCode Sync

QRCode Sync

Sincronizzazione di più attuatori, Regolazione parametri, Registrazione e Diagnostica in tempo reale tramite una semplice scansione del QRCode.

Synchronization of multiple actuators, Parameter adjustment, Recording and Diagnostics in real time by simply scanning the QRCode.

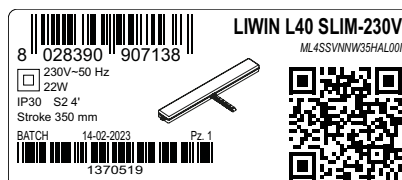

Resistenza

Resistance

L'involucro in alluminio estruso e le staffe in alluminio pressofuso garantiscono un'elevata resistenza anche in ambienti particolarmente difficili; l'attuatore ha superato i test di resistenza al calore previsti dalla normativa EN12101-2

The extruded aluminum casing and the die-cast aluminum brackets guarantee high resistance even in particularly difficult environments; the actuator has passed the heat resistance tests required by the EN12101-2 standard.

Caratteristiche tecniche / Technical data sheet

	LIWIN L40 Slim - 350		LIWIN L40 Slim - 350 Wi-Fi	
Forza Trazione / Traction force	400 N*	400 N*	400 N*	400 N*
Forza Spinta / Thrust force	400 N*	400 N*	400 N*	400 N*
Alimentazione / Power supply	110/230 VAC	24 VDC	110/230 VAC	24 VDC
Frequenza / Frequency	50/60 Hz	-	50/60 Hz	-
Tipo di servizio / Type of service	3 Min ON 7 Min OFF	3 Min ON 7 Min OFF	3 Min ON 7 Min OFF	3 Min ON 7 Min OFF
Velocità a vuoto / Unloaded stroke speed	11 mm/s	11 mm/s	11 mm/s	11 mm/s
Corse Disponibili / Strokes available	200 - 250 - 300 - 350	200 - 250 - 300 - 350	200 - 250 - 300 - 350 Regolazione millimetrica con app Mowin <i>Millimetric adjustment with Mowin app</i>	200 - 250 - 300 - 350 Regolazione Millimetrica con App Mowin <i>Millimetric adjustment with Mowin app</i>
Temperatura di funzionamento <i>Operating temperature</i>	-5°C + 50°C	-5°C + 50°C	-5°C + 50°C	-5°C + 50°C
Grado di Protezione IP / IP protection class	30	30	30	30
Soft START / Soft STOP	Si / Yes	Si / Yes	Si / Yes	Si / Yes
Assorbimento Corrente / Current draw	0,4 A	1 A	0,4 A	1 A
Potenza Assorbita / Power draw	42 W	24 W	42W	24 W
Rilevamento Ostacolo / Obstacle detection	Assorbimento di corrente <i>Current draw</i>	Assorbimento di corrente <i>Current draw</i>	Assorbimento di corrente <i>Current draw</i>	Assorbimento di corrente <i>Current draw</i>
Collegamento in parallelo <i>Connection in parallel</i>	Si / Yes Max 30 attuatori <i>Max 30 actuators</i>	Si / Yes Max 30 attuatori <i>Max 30 actuators</i>	Si / Yes Max 30 attuatori <i>Max 30 actuators</i>	Si / Yes Max 30 attuatori <i>Max 30 actuators</i>
Sincronizzazione / Synchronisation	No	No	Fino a 8 attuatori <i>Up to 8 actuators</i>	Fino a 8 Attuatori <i>Up to 8 actuators</i>
Dimensioni / Dimensions	26 x 41 x 563 mm	26 x 41 x 563 mm	26 x 41 x 563 mm	26 x 41 x 563 mm
Finecorsa in apertura / Open limit switch	Encoder	Encoder	Encoder	Encoder
Finecorsa in chiusura / Closed limit switch	Amperometrica <i>Amperometric</i>	Amperometrica <i>Amperometric</i>	Amperometrica <i>Amperometric</i>	Amperometrica <i>Amperometric</i>
Peso Attuatore / Actuator weight	1,25 Kg	1,25 Kg	1,25 Kg	1,25 Kg

*Vedi grafici portate attuatori pag. 68-69 / See actuators graph pag. 68-69

Catena Chain

La qualità elevata e la robustezza della catena inox a doppia maglia garantiscono la trasmissione della forza massima sia in trazione che in spinta.

The high quality and sturdiness of the double link stainless steel chain guarantees the transmission of the maximum force both in traction and in thrust.

IQ Interconnectivity IQ Interconnectivity

L'interconnettività IQ è un innovativo sistema di comunicazione wireless. Grazie al dispositivo Wi-Fi posto all'interno del motore è possibile connettersi con l'app MOWIN per una completa configurazione degli attuatori e garantisce una perfetta sincronizzazione tra più attuatori installati sulla stessa finestra.

IQ interconnectivity is an innovative wireless communication system. Thanks to the Wi-Fi device placed inside the motor, it allows you to connect with the MOWIN app for complete configuration of the actuators and guarantee perfect synchronization between multiple actuators installed on the same window.

Diagnostica Diagnostics

La Mowin App consente sia la registrazione delle ultime manovre con le eventuali anomalie segnalate, sia di effettuare una diagnostica in tempo reale per individuare eventuali errori di malfunzionamento.

L'attuatore è anche dotato di un led in grado di segnalare se ci sono eventuali anomalie.

The Mowin App allows both the recording of the last manoeuvres with any reported anomalies and real-time diagnostics to identify any malfunction errors. The actuator is also equipped with a led able to signal if there are any anomalies.

LIWIN L40 Slim - 350

LIWIN L40 Slim - 350 Wi-Fi



Configurazione dell'attuatore

Actuator configuration

Sporgere Top hung

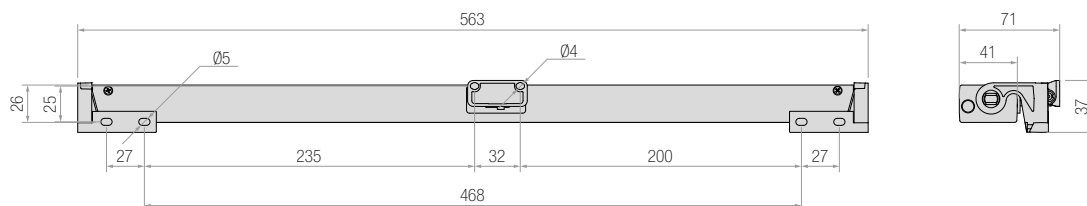

L40 Slim - 350 - Angolo di apertura anta a sporgere L40 Slim - 350 - Top hung opening angle

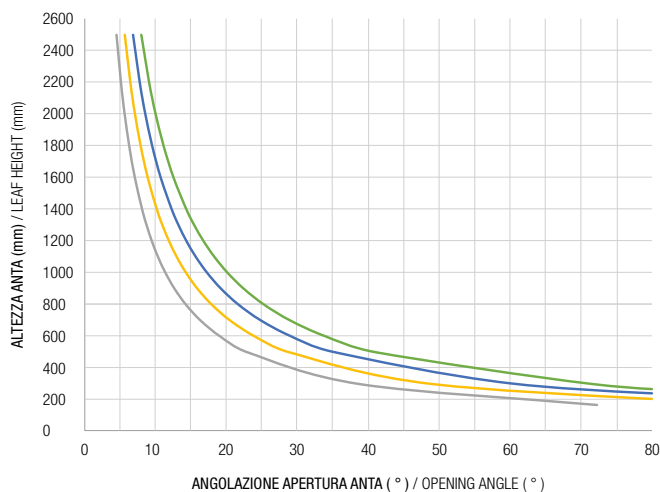

CORSA / STROKE — 200 mm — 250 mm — 300 mm — 350 mm

L40 Slim - 350 - Portate attuatori a sporgere e cupola L40 Slim - 350 - Actuator force - top hung and dome

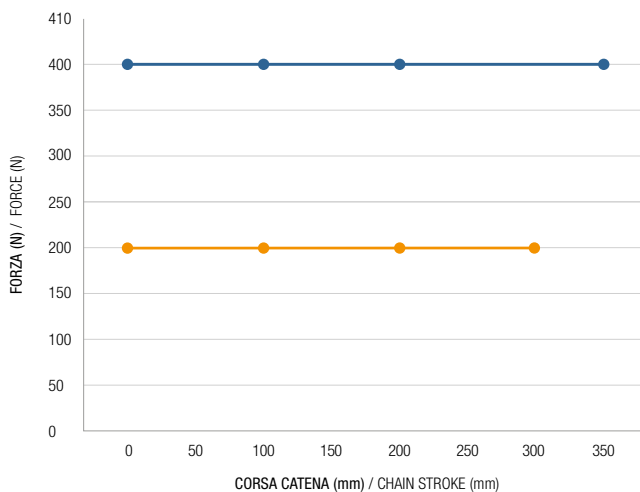

● SPORGERE / TOP HUNG OUTWARD OPENING ● CUPOLA / DOME

I valori indicati nei grafici sono da considerarsi indicativi e non considerano eventuali deformazioni dovute a fattori esterni.
The values indicated in the graphs are to be considered indicative and do not consider any deformations due to external factors.

Per scegliere l'attuatore Comunello Mowin più adatto, è necessario calcolare la FORZA (F) necessaria a sostenere il movimento della finestra. Il tipo di attuatore va selezionato considerando la combinazione tra la dimensione di BASE del serramento e la forza calcolata (N).

Per ante con BASE superiore a 1.5 metri, se il serramento è sufficientemente rigido, consigliamo l'installazione di sistemi sincronizzati come illustrato nel paragrafo Sincronizzazione di p.28.

In order to choose the most suitable Comunello Mowin actuator, you have to calculate the necessary FORCE (F) to sustain the window movement. Choose the actuator type in accordance with the CALCULATED FORCE (N) and the FRAME DIMENSION.

For leaves with a BASE greater than 1.5 metres, if the window is sufficiently rigid, we recommend the installation of synchronized systems as illustrated in the Synchronization paragraph on p.28.



Vasistas
Bottom hung

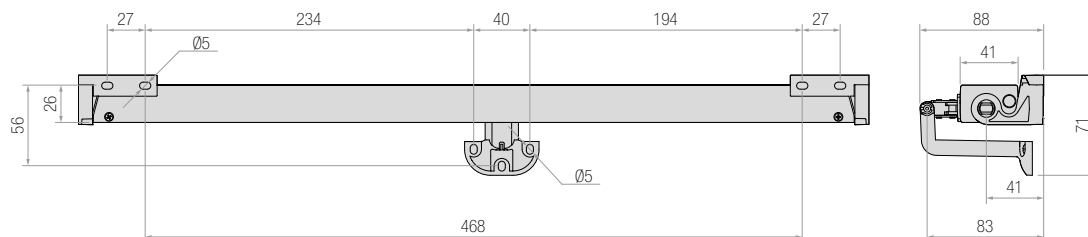

L40 Slim - 350 - Angolo di apertura anta vasistas
L40 Slim - 350 - Bottom hung opening angle



L40 Slim - 350 - Portate attuatori vasistas
L40 Slim - 350 - Actuator force - bottom hung

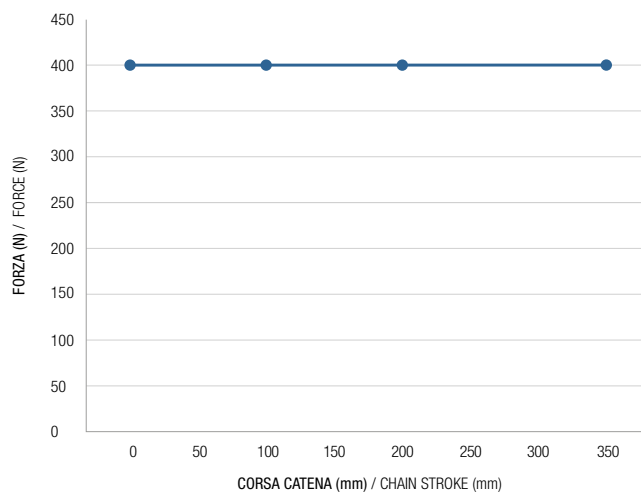
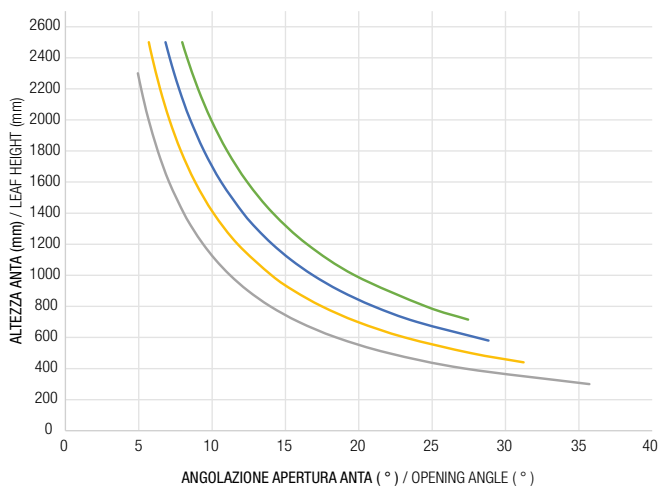

CORSA / STROKE — 200 mm — 250 mm — 300 mm — 350 mm

● VASISTAS / BOTTOM HUNG INWARD OPENING

I valori indicati nei grafici sono da considerarsi indicativi e non considerano eventuali deformazioni dovute a fattori esterni.
The values indicated in the graphs are to be considered indicative and do not consider any deformations due to external factors.

Formule per il calcolo della forza necessaria a movimentare il serramento

Formulas for calculating the force necessary to move the window

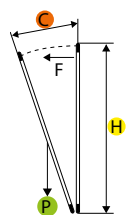

$$\frac{C \div H}{F} \times \frac{P \div 2}{F} = F \text{ Kg}$$

$$F \text{ (Kg)} \times 9,8 = \mathbf{N F \text{ (N)}}$$

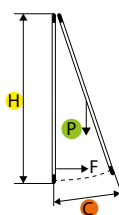

$$\frac{C \div H}{F} \times \frac{P \div 2}{F} = F \text{ Kg}$$

$$F \text{ (Kg)} \times 9,8 = \mathbf{N F \text{ (N)}}$$

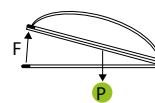

$$\frac{P}{F} \div 2 = F \text{ Kg}$$

$$F \text{ (Kg)} \times 9,8 = \mathbf{N F \text{ (N)}}$$

F = Forza necessaria
Necessary Force (Kg)









C = Corsa di apertura
Opening stroke (mm)

H = Altezza serramento
Window height (mm)





P = Peso serramento
Window weight (Kg)

LIWIN L40 Slim - 350

LIWIN L40 Slim - 350 Wi-Fi

Article	Commercial code	Product code	Push / pull*	Strokes	Colour	Power supply	Weight	Pcs
LIWIN L40 Slim	L40 SLIM 230V - 350 	ML4S S VN NW 35H AL00 I	400 N	200 - 250 - 300 - 350 mm	GRIGIO / Grey 	110/230VAC	1,25 kg	1
LIWIN L40 Slim	L40 SLIM RWA - 350 	ML4S S RW NW 35L AL00 I	400 N	200 - 250 - 300 - 350 mm	GRIGIO / Grey 	24VDC	1,25 kg	1
LIWIN L40 Slim Wi-Fi	L40 SLIM 230V-WF - 350 	ML4S S VN WF 35H AL00 I	400 N	200 - 250 - 300 - 350 mm	GRIGIO / Grey 	110/230VAC	1,25 kg	1
LIWIN L40 Slim Wi-Fi	L40 SLIM RWA-WF - 350 	ML4S S RW WF 35L AL00 I	400 N	200 - 250 - 300 - 350 mm	GRIGIO / Grey 	24VDC	1,25 kg	1

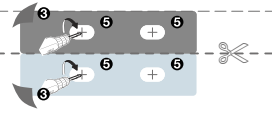
*Vedi grafici portate attuatori p.68-69 / *See actuator graph p.68-69

La confezione contiene - Box contains:				
	Attuatore (staffe escluse) Actuator (brackets excluded)		Dima per l'installazione Mounting template	
			Manuale d'uso User manual	



LIWIN L40 Slim - 600

LIWIN L40 Slim - 600 Wi-Fi



Attuatore elettromeccanico in alluminio estruso modello LIWIN L40 Slim - 600 con catena a doppia maglia e spessore maggiorato. Grazie alle dimensioni complessivamente ridotte ed in particolare allo spessore di soli 26 mm LIWIN L40 Slim - 600 è particolarmente adatto ad installazioni su spazi ristretti. La nuova tecnologia Wi-Fi, oltre a dare la possibilità di regolare parametri come velocità e corsa della catena consente la sincronizzazione fino a 8 attuatori da poter installare in un'unica finestra di grandi dimensioni o su sistemi in cui è necessaria una forza elevata. La Mowin App consente inoltre di fare una diagnostica real time degli attuatori molto utile per risalire alle cause di eventuali anomalie.

L'attuatore LIWIN L40 Slim - 600 ha superato tutti i test di resistenza al calore previsti dalla normativa EN 12101-2 per la certificazione di evacuatori fumo e calore ed è quindi in grado di soddisfare i relativi requisiti necessari per essere implementato nei sistemi RWA.

Electromechanical actuator in extruded aluminium model LIWIN L40 Slim - 600 with double link chain and increased thickness. Thanks to the overall reduced dimensions and in particular to the thickness of only 26 mm, LIWIN L40 Slim - 600 is particularly suitable for installations in confined spaces. The new Wi-Fi technology, in addition to giving the possibility to adjust parameters such as speed and stroke of the chain, allows synchronization of up to 8 actuators that can be installed in a single large window or on systems where a high force is required. The Mowin App also allows real-time diagnostics of the actuators, which is very useful for tracing the causes of any anomalies.

The LIWIN L40 Slim - 600 actuator has passed the tests required by the EN 12101-2 standard for the certification of smoke and heat extractors and is therefore able to meet all the necessary requirements to be implemented in RWA systems.



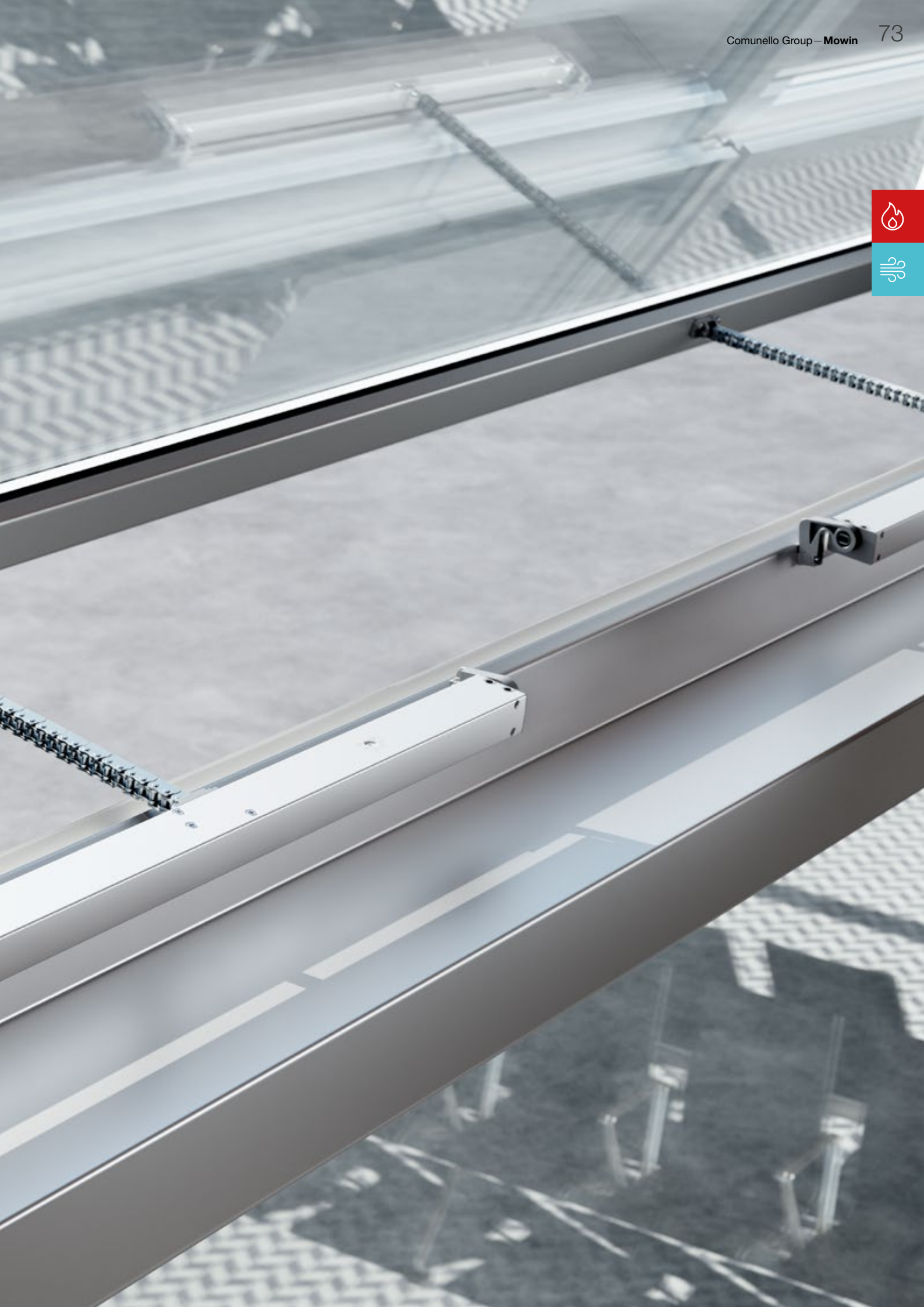

LIWIN L40 Slim - 600

LIWIN L40 Slim - 600 Wi-Fi



Attuatore a catena per apertura e chiusura di finestre in legno, PVC, alluminio e acciaio. Adatto ad aperture a vasistas, sporgere, battente e aperture parallele.

Chain actuator for opening and closing wooden, PVC, aluminum and steel windows. Suitable for bottom-hung, projecting, casement and parallel openings.



Time	Destination	Flight	Distance	Status	Remarks
10:15	Albany	KL 5021	8 min	OK	
10:20	Lima	KL 5243	8 min	OK	
10:25	London Heathrow	KL 1009	8 min	OK	Gate open
10:28	Berlin	KL 5081	8 min	OK	Gate closed
10:30	Detroit	NW 8277	8 min	OK	Gate closed
10:38	Portland	NW 5062	8 min	OK	Gate closed
10:45	Oslo	NW 6081	8 min	OK	Boarding
10:55	Copenhagen	IC 832	8 min	OK	Gate open
10:55	Stockholm	IK 354	8 min	OK	Gate open
10:55	Lisbon	MS 2151	8 min	OK	Boarding
10:58	London City	BA 433	8 min	OK	Boarding
10:58	Sofia	VO 221	8 min	OK	Gate closed
10:58	Hannover	FB 862	8 min	OK	Gate open
10:58	Helsinki	KL 5991	8 min	OK	Gate open
10:58	Helsinki	CD 970	8 min	OK	Gate open



LIWIN L40 Slim - 600

LIWIN L40 Slim - 600 Wi-Fi

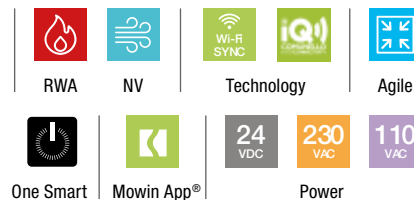

Trimmer

Posizione M: Stato attuatore SLAVE
 Posizioni 1-2-3-4: Impostazione corsa catena: 400-500-550-600 mm. La corsa dell'attuatore può essere regolata millimetricamente fino a 600 mm mediante Mowin App.
 Posizione A: Wi-Fi attivo - MASTER.

Trimmer

Position M: Slave actuator status
Positions 1-2-3-4: Chain stroke setting: 400-500-550-600 mm. The stroke of the actuator can be adjusted in millimeters up to 600 mm using the Mowin App.
Position A: WiFi activated - MASTER

 **Vasistas**
Bottom hung



 **Sporgere**
Top hung



Caratteristiche principali

Main features

Forza

Force

Gli attuatori della serie LIWIN L40 Slim hanno una forza di spinta e trazione massima pari a 400N. Grazie alla funzione di sincronizzazione è possibile ottenere una forza massima totale fino a 2240N.

The LIWIN L40 Slim series actuators have a maximum push and pull force of 400N. Thanks to the synchronization function it is possible to obtain a total maximum force up to 2240N.

QRCode Sync

QRCode Sync

Sincronizzazione di più attuatori, Regolazione parametri, Registrazione e Diagnostica in tempo reale tramite una semplice scansione del QRCode.

Synchronization of multiple actuators, Parameter adjustment, Recording and Diagnostics in real time by simply scanning the QRCode.

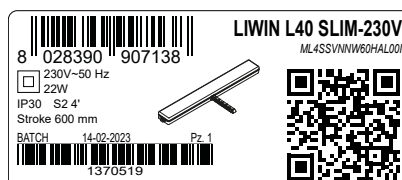

Resistenza

Resistance

L'involucro in alluminio estruso e le staffe in alluminio pressofuso garantiscono un'elevata resistenza anche in ambienti particolarmente difficili; l'attuatore ha superato i test di resistenza al calore previsti dalla normativa EN12101-2

The extruded aluminum casing and the die-cast aluminum brackets guarantee high resistance even in particularly difficult environments; the actuator has passed the heat resistance tests required by the EN12101-2 standard.

Caratteristiche tecniche / Technical data sheet

	LIWIN L40 Slim - 600		LIWIN L40 Slim - 600 Wi-Fi	
Forza Trazione / Traction force	400 N*	400 N*	400 N*	400 N*
Forza Spinta / Thrust force	400 N*	400 N*	400 N*	400 N*
Alimentazione / Power supply	110/230 VAC	24 VDC	110/230 VAC	24 VDC
Frequenza / Frequency	50/60 Hz	-	50/60 Hz	-
Tipo di servizio / Type of service	3 Min ON 7 Min OFF	3 Min ON 7 Min OFF	3 Min ON 7 Min OFF	3 Min ON 7 Min OFF
Velocità a vuoto / Unloaded stroke speed	11 mm/s	11 mm/s	11 mm/s	11 mm/s
Corse Disponibili / Strokes available	400 - 500 - 550 - 600	400 - 500 - 550 - 600	400 - 500 - 550 - 600 Regolazione millimetrica con app Mowin Millimetric adjustment with Mowin app	400 - 500 - 550 - 600 Regolazione Millimetrica con App Mowin Millimetric adjustment with Mowin app
Temperatura di funzionamento Operating temperature	-5°C + 50°C	-5°C + 50°C	-5°C + 50°C	-5°C + 50°C
Grado di Protezione IP / IP protection class	30	30	30	30
Soft START / Soft STOP	Si / Yes	Si / Yes	Si / Yes	Si / Yes
Assorbimento di corrente / Current draw	0,4 A	1 A	0,4 A	1 A
Potenza assorbita	42 W	24 W	42 W	24 W
Rilevamento Ostacolo / Obstacle detection	Assorbimento di corrente Current draw	Assorbimento di corrente Current draw	Assorbimento di corrente Current draw	Assorbimento di corrente Current draw
Collegamento in parallelo Connection in parallel	Si / Yes Max 30 attuatori Max 30 actuators	Si / Yes Max 30 attuatori Max 30 actuators	Si / Yes Max 30 attuatori Max 30 actuators	Si / Yes Max 30 attuatori Max 30 actuators
Sincronizzazione / Synchronisation	No	No	Fino a 8 attuatori Up to 8 actuators	Si fino a 8 Attuatori Up to 8 actuators
Dimensioni / Dimensions	26 x 41 x 688 mm	26 x 41 x 688 mm	26 x 41 x 688 mm	26 x 41 x 688 mm
Fincorsa in apertura / Open limit switch	Encoder	Encoder	Encoder	Encoder
Fincorsa in chiusura / Closed limit switch	Amperometrica Amperometric	Amperometrica Amperometric	Amperometrica Amperometric	Amperometrica Amperometric
Peso Attuatore / Actuator weight	1,50 kg	1,50 kg	1,50 kg	1,50 kg

*Vedi grafici portate attuatori pag. 78-79 / See actuators graph pag. 78-79

Catena Chain

La qualità elevata e la robustezza della catena inox a doppia maglia garantiscono la trasmissione della forza massima sia in trazione che in spinta.

The high quality and sturdiness of the double link stainless steel chain guarantee the transmission of the maximum force both in traction and in thrust.

IQ Interconnectivity IQ Interconnectivity

L'interconnettività IQ è un innovativo sistema di comunicazione wireless. Grazie al dispositivo Wi-Fi posto all'interno del motore è possibile connettersi con l'app MOWIN per una completa configurazione degli attuatori e garantisce una perfetta sincronizzazione tra più attuatori installati sulla stessa finestra.

IQ interconnectivity is an innovative wireless communication system. Thanks to the Wi-Fi device placed inside the motor, it allows you to connect with the MOWIN app for complete configuration of the actuators and guarantee perfect synchronization between multiple actuators installed on the same window.

Diagnostica Diagnostics

La Mowin App consente sia la registrazione delle ultime manovre con le eventuali anomalie segnalate, sia di effettuare una diagnostica in tempo reale per individuare eventuali errori di malfunzionamento.

L'attuatore è anche dotato di un led in grado di segnalare se ci sono eventuali anomalie.

The Mowin App allows both the recording of the last manoeuvres with any reported anomalies and real-time diagnostics to identify any malfunction errors. The actuator is also equipped with a led able to signal if there are any anomalies.

LIWIN L40 Slim - 600

LIWIN L40 Slim - 600 Wi-Fi

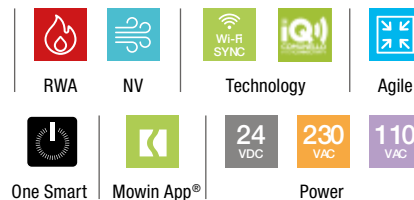

Configurazione dell'attuatore

Actuator configuration

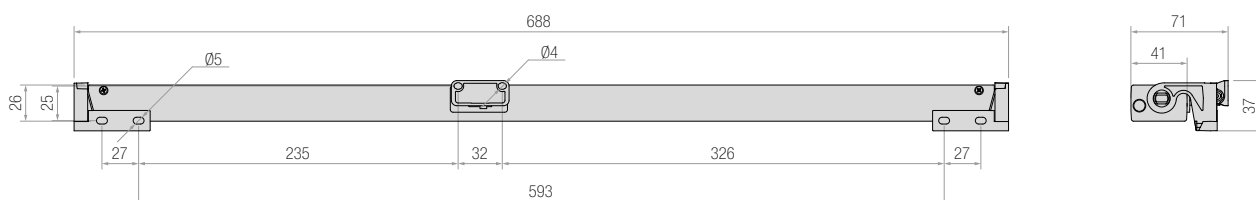

L40 Slim - 600 - Angolo di apertura anta a sporgere
L40 Slim - 600 - Top hung opening angle

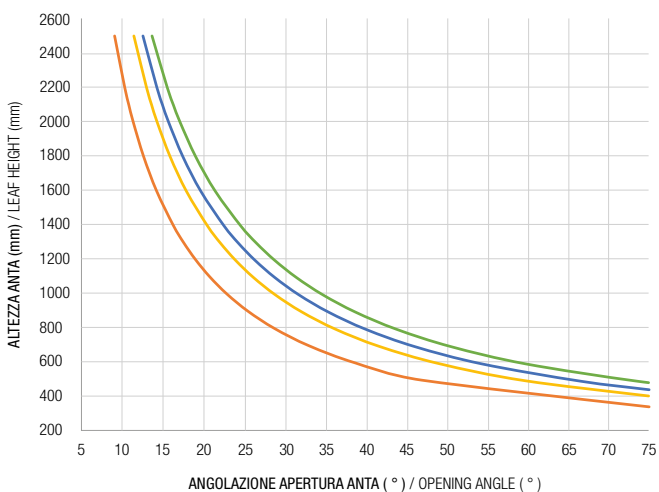

L40 Slim - 600 - Portate attuatori a sporgere
L40 Slim - 600 - Actuator force - top hung and dome

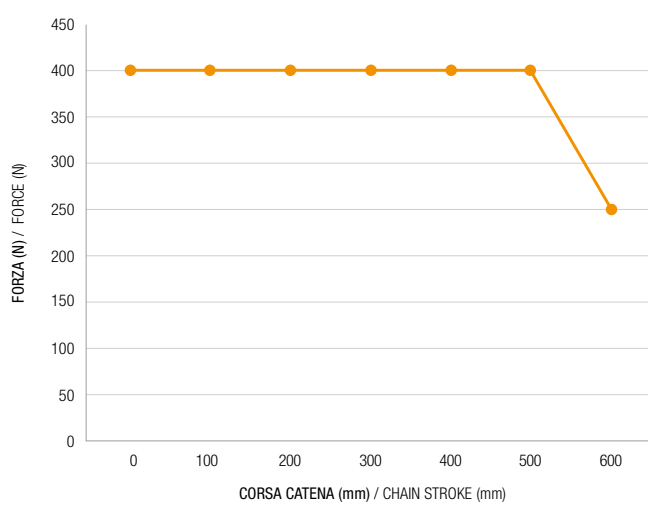

SPORGERE / TOP HUNG OUTWARD OPENING

I valori indicati nei grafici sono da considerarsi indicativi e non considerano eventuali deformazioni dovute a fattori esterni.
The values indicated in the graphs are to be considered indicative and do not consider any deformations due to external factors.

Per scegliere l'attuatore Comunello Mowin più adatto, è necessario calcolare la FORZA (F) necessaria a sostenere il movimento della finestra. Il tipo di attuatore va selezionato considerando la combinazione tra la dimensione di BASE del serramento e la forza calcolata (N).

Per ante con BASE superiore a 1.5 metri, se il serramento è sufficientemente rigido, consigliamo l'installazione di sistemi sincronizzati come illustrato nel paragrafo Sincronizzazione di p.28.

In order to choose the most suitable Comunello Mowin actuator, you have to calculate the necessary FORCE (F) to sustain the window movement. Choose the actuator type in accordance with the CALCULATED FORCE (N) and the FRAME DIMENSION.

For leaves with a BASE greater than 1.5 metres, if the window is sufficiently rigid, we recommend the installation of synchronized systems as illustrated in the Synchronization paragraph on p.28.

Vasistas
Bottom hung

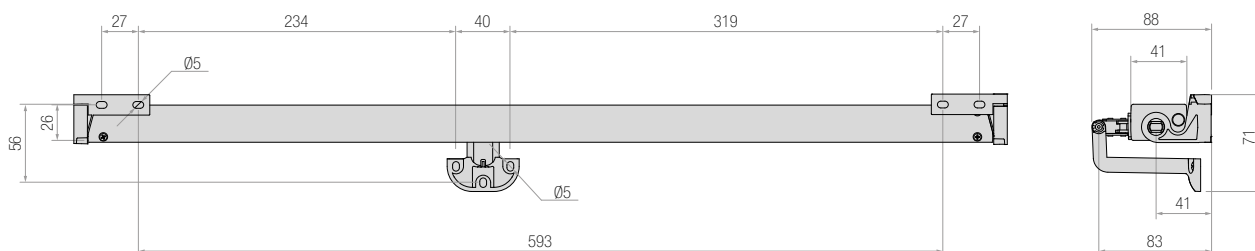

L40 Slim - 600 - Angolo di apertura anta vasistas
L40 Slim - 600 - Bottom hung opening angle

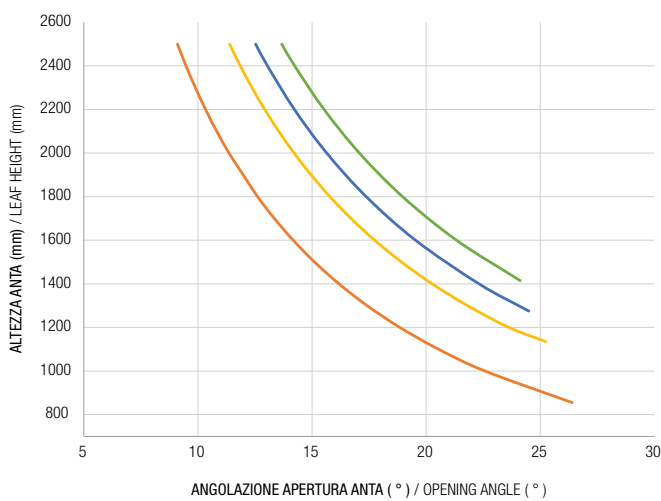

L40 Slim - 600 - Portate attuatori vasistas
L40 Slim - 600 - Actuator force - bottom hung

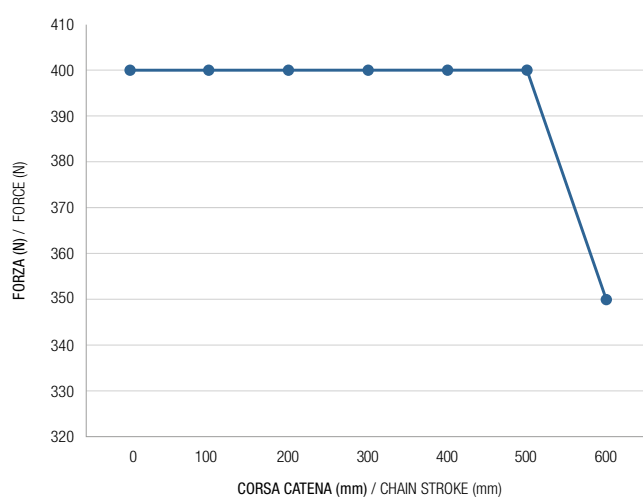

I valori indicati nei grafici sono da considerarsi indicativi e non considerano eventuali deformazioni dovute a fattori esterni.
The values indicated in the graphs are to be considered indicative and do not consider any deformations due to external factors.

Formule per il calcolo della forza necessaria a movimentare il serramento *Formulas for calculating the force necessary to move the window*

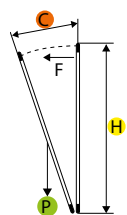

$$\frac{C \div H}{F} \times \frac{P \div 2}{N} = F \text{ Kg}$$

$$F \text{ (Kg)} \times 9,8 = \mathbf{N F \text{ (N)}}$$

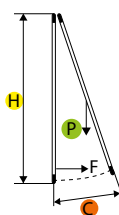

$$\frac{C \div H}{F} \times \frac{P \div 2}{N} = F \text{ Kg}$$

$$F \text{ (Kg)} \times 9,8 = \mathbf{N F \text{ (N)}}$$

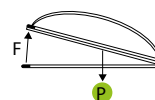

$$\frac{P}{2} = F \text{ Kg}$$

$$F \text{ (Kg)} \times 9,8 = \mathbf{N F \text{ (N)}}$$

F = Forza necessaria
Necessary Force (Kg)









C = Corsa di apertura
Opening stroke (mm)

H = Altezza serramento
Window height (mm)





P = Peso serramento
Window weight (Kg)

LIWIN L40 Slim - 600

LIWIN L40 Slim - 600 Wi-Fi

Article	Commercial code	Product code	Push / pull*	Strokes	Colour	Power supply	Weight	Pcs
LIWIN L40 Slim	L40 SLIM 230V - 600 	ML4S S VN NW 60H AL00 I	400 N	400 - 500 - 550 - 600 mm	GRIGIO / Grey 	110/230VAC	1,50 kg	1
LIWIN L40 Slim	L40 SLIM RWA - 600 	ML4S S RW NW 60L AL00 I	400 N	400 - 500 - 550 - 600 mm	GRIGIO / Grey 	24VDC	1,50 kg	1
LIWIN L40 Slim Wi-Fi	L40 SLIM 230V-WF - 600 	ML4S S VN WF 60H AL00 I	400 N	400 - 500 - 550 - 600 mm	GRIGIO / Grey 	110/230VAC	1,50 kg	1
LIWIN L40 Slim Wi-Fi	L40 SLIM RWA-WF - 600 	ML4S S RW WF 60L AL00 I	400 N	400 - 500 - 550 - 600 mm	GRIGIO / Grey 	24VDC	1,50 kg	1

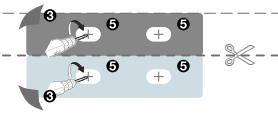
*Vedi grafici portate attuatori p.78-79 / *See actuator graph p.78-79

La confezione contiene - Box contains:				
	Attuatore (staffe escluse) Actuator (brackets excluded)		Dima per l'installazione Mounting template	
			Manuale d'uso User manual	



LIWIN L40 Slim - 800

LIWIN L40 Slim - 800 Wi-Fi



Attuatore elettromeccanico in alluminio estruso modello LIWIN L40 Slim - 800 con catena a doppia maglia e spessore maggiorato. Grazie alle dimensioni complessivamente ridotte ed in particolare allo spessore di soli 26 mm LIWIN L40 Slim - 800 è particolarmente adatto ad installazioni su spazi ristretti. La nuova tecnologia Wi-Fi, oltre a dare la possibilità di regolare parametri come velocità e corsa della catena consente la sincronizzazione fino a 8 attuatori da poter installare in un'unica finestra di grandi dimensioni o su sistemi in cui è necessaria una forza elevata. La nuova app Comunello Mowin consente inoltre di fare una diagnostica real time degli attuatori molto utile per risalire alle cause di eventuali anomalie.

L'attuatore LIWIN L40 Slim - 800 ha superato tutti i test di resistenza al calore previsti dalla normativa EN 12101-2 per la certificazione di evacuatori fumo e calore ed è quindi in grado di soddisfare i relativi requisiti necessari per essere implementato nei sistemi RWA.

Electromechanical actuator in extruded aluminium model LIWIN L40 Slim - 800 with double link chain and increased thickness. Thanks to the overall reduced dimensions and in particular to the thickness of only 26 mm, LIWIN L40 Slim - 800 is particularly suitable for installations in confined spaces. The new Wi-Fi technology, in addition to giving the possibility to adjust parameters such as speed and stroke of the chain, allows synchronization of up to 8 actuators that can be installed in a single large window or on systems where a high force is required. The new Comunello Mowin app also allows real-time diagnostics of the actuators, which is very useful for tracing the causes of any anomalies.

The LIWIN L40 Slim - 800 actuator has passed all the tests required by the EN 12101-2 standard for the certification of smoke and heat extractors and is therefore able to meet all the necessary requirements to be implemented in RWA systems.





LIWIN L40 Slim - 800

LIWIN L40 Slim - 800 Wi-Fi



Attuatore a catena per apertura e chiusura di finestre in legno, PVC, alluminio e acciaio. Adatto ad aperture a vasistas, sporgere, battente e aperture parallele.

Chain actuator for opening and closing wooden, PVC, aluminum and steel windows. Suitable for bottom-hung, projecting, casement and parallel openings.

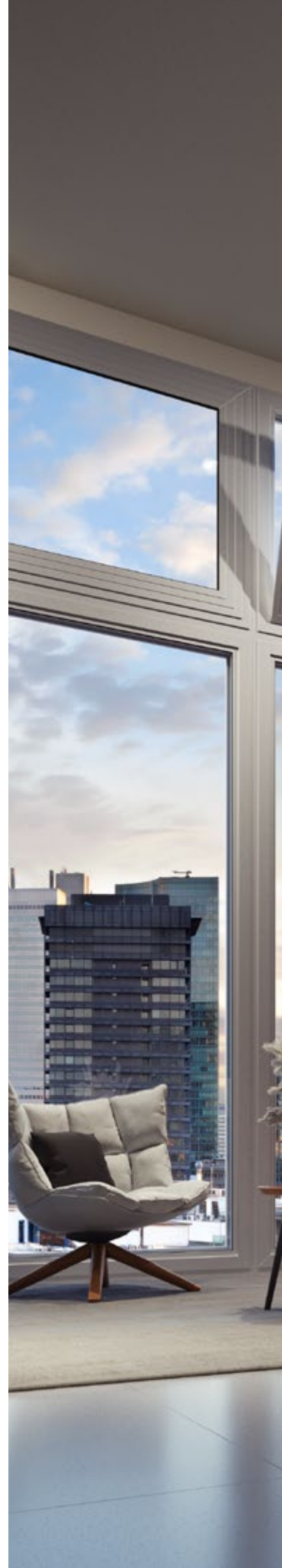



LIWIN L40 Slim - 800

LIWIN L40 Slim - 800 Wi-Fi



Trimmer

Posizione M: Stato attuatore SLAVE
 Posizioni 1-2-3-4: Impostazione corsa catena: 650-700-750-800 mm. La corsa dell'attuatore può essere regolata millimetricamente fino a 800 mm mediante Mowin App.
 Posizione A: Wi-Fi attivo - MASTER.

Trimmer

Position M: Slave actuator status
 Positions 1-2-3-4: Chain stroke setting: 650-700-750-800 mm. The stroke of the actuator can be adjusted in millimeters up to 800 mm using the Mowin App.
 Position A: WiFi activated - MASTER.

 **Vasistas**
Bottom hung



 **Sporgere**
Top hung



Caratteristiche principali

Main features

Forza

Force

Gli attuatori della serie LIWIN L40 Slim hanno una forza di spinta e trazione massima pari a 400N. Grazie alla funzione di sincronizzazione è possibile ottenere una forza massima totale fino a 2240N.

The LIWIN L40 Slim series actuators have a maximum push and pull force of 400N. Thanks to the synchronization function it is possible to obtain a total maximum force up to 2240N.

QRCode Sync

QRCode Sync

Sincronizzazione di più attuatori, Regolazione parametri, Registrazione e Diagnostica in tempo reale tramite una semplice scansione del QRCode.

Synchronization of multiple actuators, Parameter adjustment, Recording and Diagnostics in real time by simply scanning the QRCode.

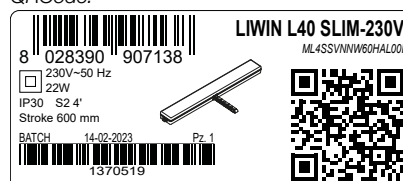

Resistenza

Resistance

L'involucro in alluminio estruso e le staffe in alluminio pressofuso garantiscono un'elevata resistenza anche in ambienti particolarmente difficili; l'attuatore ha superato i test di resistenza al calore previsti dalla normativa EN12101-2

The extruded aluminum casing and the die-cast aluminum brackets guarantee high resistance even in particularly difficult environments; the actuator has passed the heat resistance tests required by the EN12101-2 standard.

Caratteristiche tecniche / Technical data sheet

	LIWIN L40 Slim - 800		LIWIN L40 Slim - 800 Wi-Fi	
Forza Trazione / <i>Traction force</i>	400 N*	400 N*	400 N*	400 N*
Forza Spinta / <i>Thrust force</i>	400 N*	400 N*	400 N*	400 N*
Alimentazione / <i>Power supply</i>	110/230 VAC	24 VDC	110/230 VAC	24 VDC
Frequenza / <i>Frequency</i>	50 / 60 Hz	-	50 / 60 Hz	-
Tipo di servizio / <i>Type of service</i>	3 Min ON 7 Min OFF	3 Min ON 7 Min OFF	3 Min ON 7 Min OFF	3 Min ON 7 Min OFF
Velocità a vuoto / <i>Unloaded stroke speed</i>	11mm/s	11 mm/s	11 mm/s	11 mm/s
Corse Disponibili / <i>Strokes available</i>	650 - 700 - 750 - 800	650 - 700 - 750 - 800	650 - 700 - 750 - 800 Regolazione millimetrica con app Mowin <i>Millimetric adjustment with Mowin app</i>	650 - 700 - 750 - 800 Regolazione Millimetrica con App Mowin <i>Millimetric adjustment with Mowin app</i>
Temperatura di funzionamento <i>Operating temperature</i>	-5°C + 50°C	-5°C + 50°C	-5°C + 50°C	-5°C + 50°C
Grado di Protezione IP / <i>IP protection class</i>	30	30	30	30
Soft START / Soft STOP	Si / Yes	Si / Yes	Si / Yes	Si / Yes
Assorbimento di corrente / <i>Current draw</i>	0,4 A	1 A	0,4 A	1 A
Potenza assorbita	42 W	24 W	42 W	24 W
Rilevamento Ostacolo / <i>Obstacle detection</i>	Assorbimento di corrente <i>Current draw</i>	Assorbimento di corrente <i>Current draw</i>	Assorbimento di corrente <i>Current draw</i>	Assorbimento di corrente <i>Current draw</i>
Collegamento in parallelo <i>Connection in parallel</i>	Si / Yes Max 30 attuatori <i>Max 30 actuators</i>	Si / Yes Max 30 attuatori <i>Max 30 actuators</i>	Si / Yes Max 30 attuatori <i>Max 30 actuators</i>	Si / Yes Max 30 attuatori <i>Max 30 actuators</i>
Sincronizzazione / <i>Synchronisation</i>	No	No	Fino a 8 attuatori <i>Up to 8 actuators</i>	Fino a 8 attuatori <i>Up to 8 actuators</i>
Dimensioni / <i>Dimensions</i>	26 x 41 x 788 mm	26 x 41 x 788 mm	26 x 41 x 788 mm	26 x 41 x 788 mm
Fincorsa in apertura / <i>Open limit switch</i>	Encoder	Encoder	Encoder	Encoder
Fincorsa in chiusura / <i>Closed limit switch</i>	Amperometrica <i>Amperometric</i>	Amperometrica <i>Amperometric</i>	Amperometrica <i>Amperometric</i>	Amperometrica <i>Amperometric</i>
Peso Attuatore / <i>Actuator weight</i>	1,70 Kg	1,70 Kg	1,70 Kg	1,70 Kg

*Vedi grafici portate attuatori pag. 88-89 / *See actuators graph pag. 88-89*

Catena Chain

La qualità elevata e la robustezza della catena inox a doppia maglia garantiscono la trasmissione della forza massima sia in trazione che in spinta.

The high quality and sturdiness of the double link stainless steel chain guarantee the transmission of the maximum force both in traction and in thrust.

IQ Interconnectivity IQ Interconnectivity

L'interconnettività IQ è un innovativo sistema di comunicazione wireless. Grazie al dispositivo Wi-Fi posto all'interno del motore è possibile connettersi con l'app MOWIN per una completa configurazione degli attuatori e garantisce una perfetta sincronizzazione tra più attuatori installati sulla stessa finestra.

IQ interconnectivity is an innovative wireless communication system. Thanks to the Wi-Fi device placed inside the motor, it allows you to connect with the MOWIN app for complete configuration of the actuators and guarantee perfect synchronization between multiple actuators installed on the same window.

Diagnostica Diagnostics

La Mowin App consente sia la registrazione delle ultime manovre con le eventuali anomalie segnalate, sia di effettuare una diagnostica in tempo reale per individuare eventuali errori di malfunzionamento.

L'attuatore è anche dotato di un led in grado di segnalare se ci sono eventuali anomalie.

The Mowin App allows both the recording of the last manoeuvres with any reported anomalies and real-time diagnostics to identify any malfunction errors. The actuator is also equipped with a led able to signal if there are any anomalies.

LIWIN L40 Slim - 800

LIWIN L40 Slim - 800 Wi-Fi

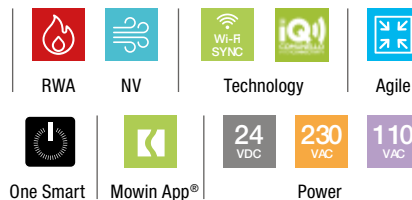

Configurazione dell'attuatore

Actuator configuration



Sporgere
Top hung

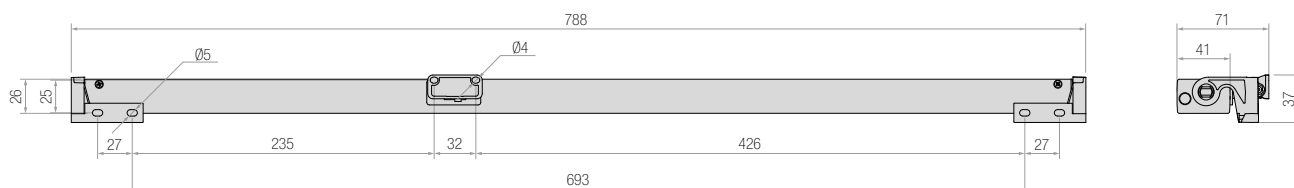

L40 Slim - 800 - Angolo di apertura anta a sporgere
L40 Slim - 800 - Top hung opening angle

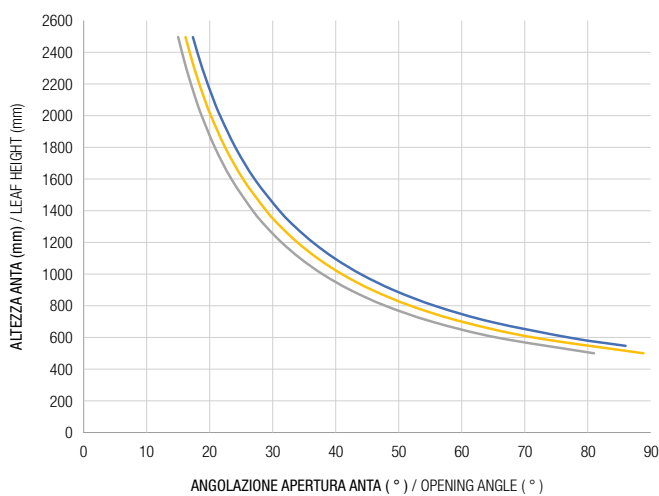

CORSA / STROKE — 650 mm — 700 mm — 750 mm

L40 Slim - 800 - Portate attuatori a sporgere
L40 Slim - 800 - Actuator force - top hung and dome

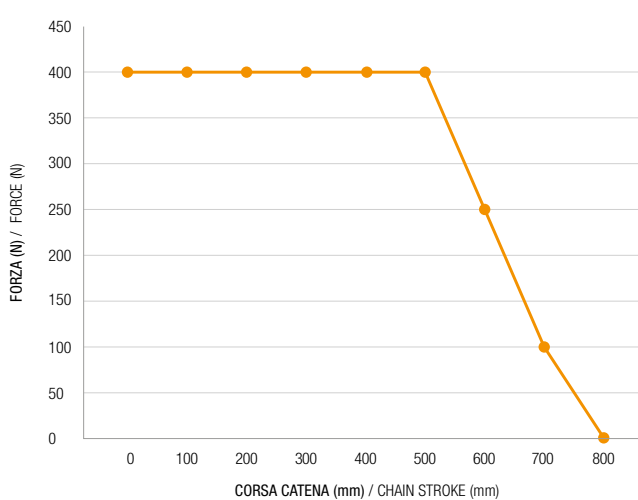

— SPORGERE / TOP HUNG OUTWARD OPENING

I valori indicati nei grafici sono da considerarsi indicativi e non considerano eventuali deformazioni dovute a fattori esterni.
The values indicated in the graphs are to be considered indicative and do not consider any deformations due to external factors.

Per scegliere l'attuatore Comunello Mowin più adatto, è necessario calcolare la FORZA (F) necessaria a sostenere il movimento della finestra. Il tipo di attuatore va selezionato considerando la combinazione tra la dimensione di BASE del serramento e la forza calcolata (N).

Per ante con BASE superiore a 1.5 metri, se il serramento è sufficientemente rigido, consigliamo l'installazione di sistemi sincronizzati come illustrato nel paragrafo Sincronizzazione di p.28.

In order to choose the most suitable Comunello Mowin actuator, you have to calculate the necessary FORCE (F) to sustain the window movement. Choose the actuator type in accordance with the CALCULATED FORCE (N) and the FRAME DIMENSION.

For leaves with a BASE greater than 1.5 metres, if the window is sufficiently rigid, we recommend the installation of synchronized systems as illustrated in the Synchronization paragraph on p.28.

Vasistas
Bottom hung

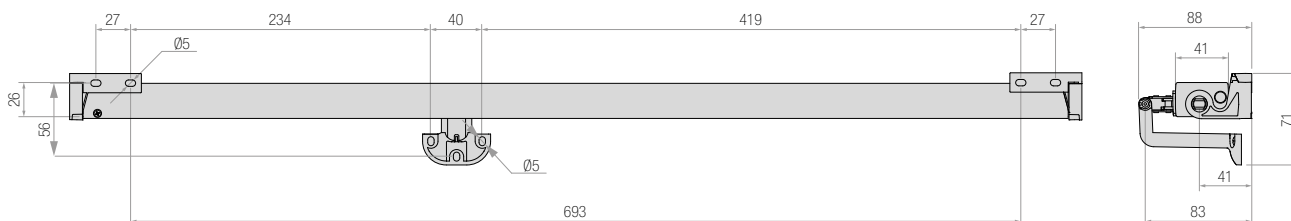

L40 Slim - 800 - Angolo di apertura anta vasistas
L40 Slim - 800 - Bottom hung opening angle

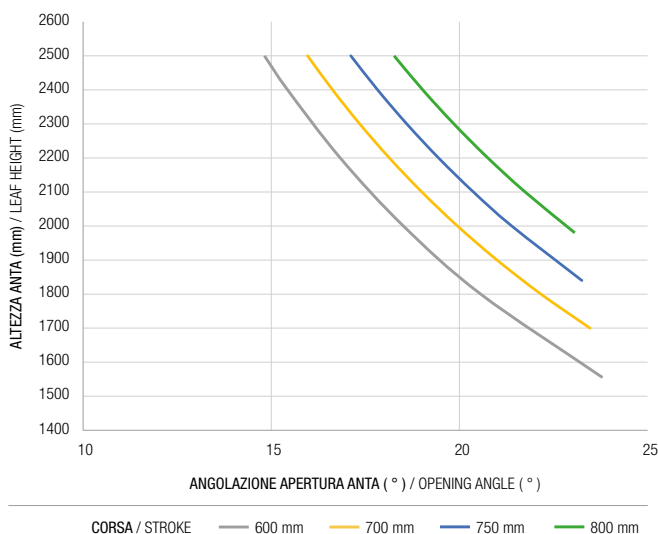

L40 Slim - 800 - Portate attuatori vasistas
L40 Slim - 800 - Actuator force - bottom hung

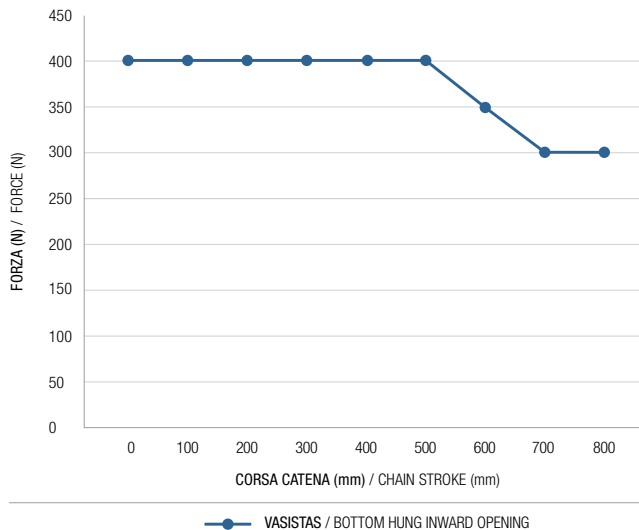

I valori indicati nei grafici sono da considerarsi indicativi e non considerano eventuali deformazioni dovute a fattori esterni.
The values indicated in the graphs are to be considered indicative and do not consider any deformations due to external factors.

Formule per il calcolo della forza necessaria a movimentare il serramento / Formulas for calculating the force necessary to move the window

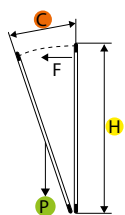

$$\frac{C \div H}{F} \times (P \div 2) = F \text{ Kg}$$

$$F (\text{Kg}) \times 9,8 = \mathbf{N F (N)}$$

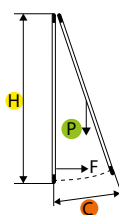

$$\frac{C \div H}{F} \times (P \div 2) = F \text{ Kg}$$

$$F (\text{Kg}) \times 9,8 = \mathbf{N F (N)}$$

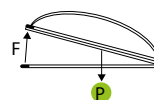

$$P \div 2 = F \text{ Kg}$$

$$F (\text{Kg}) \times 9,8 = \mathbf{N F (N)}$$

F = Forza necessaria
Necessary Force (Kg)









C = Corsa di apertura
Opening stroke (mm)

H = Altezza serramento
Window height (mm)

P = Peso serramento
Window weight (Kg)

LIWIN L40 Slim - 800

LIWIN L40 Slim - 800 Wi-Fi

Article	Commercial code	Product code	Push / pull*	Strokes	Colour	Power supply	Weight	Pcs
LIWIN L40 Slim	L40 SLIM 230V - 800	 ML4S S VN NW 80H AL00 I	400 N	650 - 700 - 750 - 800 mm	GRIGIO / Grey 	110/230VAC	1,70 kg	1
LIWIN L40 Slim	L40 SLIM RWA - 800	 ML4S S RW NW 80L AL00 I	400 N	650 - 700 - 750 - 800 mm	GRIGIO / Grey 	24VDC	1,70 kg	1
LIWIN L40 Slim Wi-Fi	L40 SLIM 230V-WF - 800	 ML4S S VN WF 80H AL00 I	400 N	650 - 700 - 750 - 800 mm	GRIGIO / Grey 	110/230VAC	1,70 kg	1
LIWIN L40 Slim Wi-Fi	L40 SLIM RWA-WF - 800	 ML4S S RW WF 80L AL00 I	400 N	650 - 700 - 750 - 800 mm	GRIGIO / Grey 	24VDC	1,70 kg	1

*Vedi grafici portate attuatori p.88-89 / *See actuators graph p.88-89

La confezione contiene - Box contains:

	Attuatore (staffe escluse) <i>Actuator (brackets excluded)</i>		Dima per l'installazione <i>Mounting template</i>		Manuale d'uso <i>User manual</i>	
---	---	---	--	--	-------------------------------------	---



LIWIN L40 Slim - 1000

LIWIN L40 Slim - 1000 Wi-Fi



Attuatore elettromeccanico in alluminio estruso modello LIWIN L40 Slim - 1000 con catena a doppia maglia e spessore maggiorato. Grazie alle dimensioni complessivamente ridotte ed in particolare allo spessore di soli 26 mm LIWIN L40 Slim - 1000 è particolarmente adatto ad installazioni su spazi ristretti. La nuova tecnologia Wi-Fi, oltre a dare la possibilità di regolare parametri come velocità e corsa della catena consente la sincronizzazione fino a 8 attuatori da poter installare in un'unica finestra di grandi dimensioni o su sistemi in cui è necessaria una forza elevata. La nuova app Comunello Mowin consente inoltre di fare una diagnostica real time degli attuatori molto utile per risalire alle cause di eventuali anomalie.

L'attuatore LIWIN L40 Slim - 1000 ha superato tutti i test di resistenza al calore previsti dalla normativa EN 12101-2 per la certificazione di evacuatori fumo e calore ed è quindi in grado di soddisfare i relativi requisiti necessari per essere implementato nei sistemi RWA.

Electromechanical actuator in extruded aluminium model LIWIN L40 Slim - 1000 with double link chain and increased thickness. Thanks to the overall reduced dimensions and in particular to the thickness of only 26 mm, LIWIN L40 Slim - 1000 is particularly suitable for installations in confined spaces. The new Wi-Fi technology, in addition to giving the possibility to adjust parameters such as speed and stroke of the chain, allows synchronization of up to 8 actuators that can be installed in a single large window or on systems where a high force is required. The new Comunello Mowin app also allows real-time diagnostics of the actuators, which is very useful for tracing the causes of any anomalies.

The LIWIN L40 Slim - 1000 actuator has passed all the tests required by the EN 12101-2 standard for the certification of smoke and heat extractors and is therefore able to meet all the necessary requirements to be implemented in RWA systems.

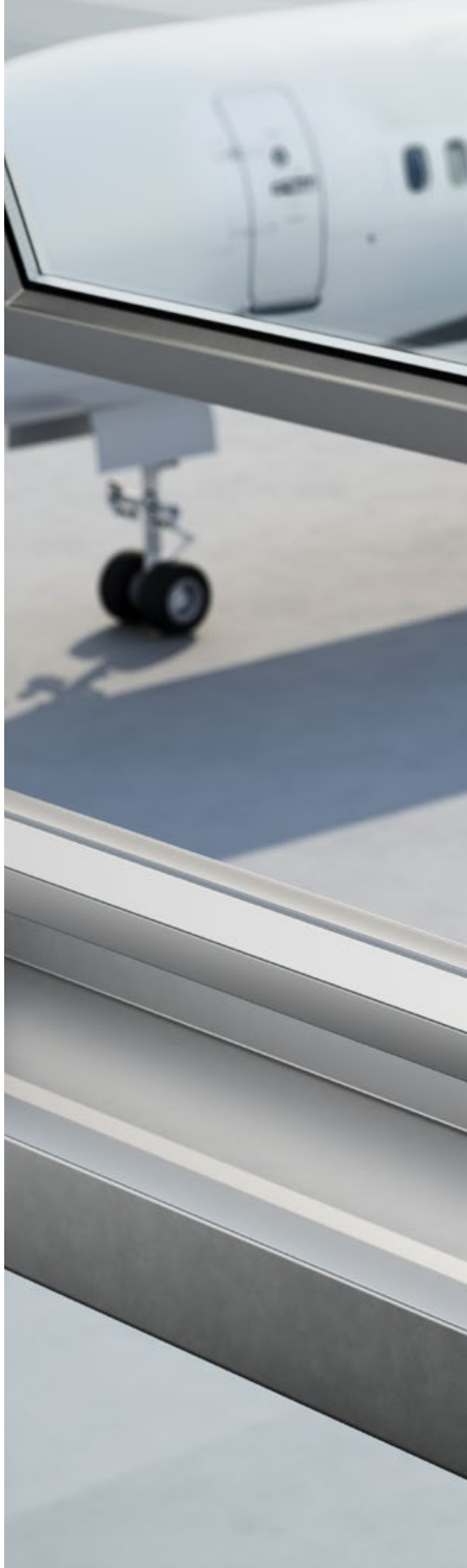



LIWIN L40 Slim - 1000

LIWIN L40 Slim - 1000 Wi-Fi



Attuatore a catena per apertura e chiusura di finestre in legno, PVC, alluminio e acciaio. Adatto ad aperture a vasistas, sporgere, battente e aperture parallele.

Chain actuator for opening and closing wooden, PVC, aluminum and steel windows. Suitable for bottom-hung, projecting, casement and parallel openings.





LIWIN L40 Slim - 1000

LIWIN L40 Slim - 1000 Wi-Fi



Trimmer

Posizione M: Stato attuatore SLAVE
 Posizioni 1-2-3-4: Impostazione corsa catena: 850-900-950-1000 mm. La corsa dell'attuatore può essere regolata millimetricamente fino a 1000 mm mediante Mowin App.

Posizione A: Wi-Fi attivo - MASTER.

Trimmer

Position M: Slave actuator status
 Positions 1-2-3-4: Chain stroke setting: 850-900-950-1000 mm. The stroke of the actuator can be adjusted in millimeters up to 1000 mm using the Mowin App.

Position A: WiFi activated - MASTER.

 **Vasistas**
Bottom hung



 **Sporgere**
Top hung



Caratteristiche principali

Main features

Forza

Force

Gli attuatori della serie LIWIN L40 Slim hanno una forza di spinta e trazione massima pari a 400N. Grazie alla funzione di sincronizzazione è possibile ottenere una forza massima totale fino a 2240N.

The LIWIN L40 Slim series actuators have a maximum push and pull force of 400N. Thanks to the synchronization function it is possible to obtain a total maximum force up to 2240N.

QRCode Sync

QRCode Sync

Sincronizzazione di più attuatori, Regolazione parametri, Registrazione e Diagnostica in tempo reale tramite una semplice scansione del QRCode.

Synchronization of multiple actuators, Parameter adjustment, Recording and Diagnostics in real time by simply scanning the QRCode.

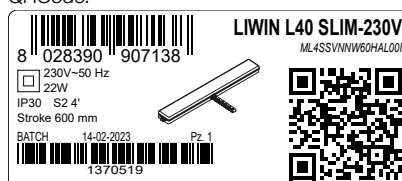

Resistenza

Resistance

L'involucro in alluminio estruso e le staffe in alluminio pressofuso garantiscono un'elevata resistenza anche in ambienti particolarmente difficili; l'attuatore ha superato i test di resistenza al calore previsti dalla normativa EN12101-2

The extruded aluminum casing and the die-cast aluminum brackets guarantee high resistance even in particularly difficult environments; the actuator has passed the heat resistance tests required by the EN12101-2 standard.

Caratteristiche tecniche / Technical data sheet

	LIWIN L40 Slim - 1000		LIWIN L40 Slim - 1000 Wi-Fi	
Forza Trazione / Traction force	400 N*	400 N*	400 N*	400 N*
Forza Spinta / Thrust force	400 N*	400 N*	400 N*	400 N*
Alimentazione / Power supply	110/230 VAC	24 VDC	110/230 VAC	24 VDC
Frequenza / Frequency	50/60 Hz	-	50/60 Hz	-
Tipo Di Servizio / Type of service	3 Min ON 7 Min OFF	3 Min ON 7 Min OFF	3 Min ON 7 Min OFF	3 Min ON 7 Min OFF
Velocità a vuoto / Unloaded stroke speed	11 mm/s	11 mm/s	11 mm/s	11 mm/s
Corse Disponibili / Strokes available	850 - 900 - 950 - 1000	850 - 900 - 950 - 1000	850 - 900 - 950 - 1000 Regolazione millimetrica con app Mowin <i>Millimetric adjustment with Mowin app</i>	850 - 900 - 950 - 1000 Regolazione Millimetrica con App Mowin <i>Millimetric adjustment with Mowin app</i>
Temperatura di funzionamento <i>Operating temperature</i>	-5°C + 50°C	-5°C + 50°C	-5°C + 50°C	-5°C + 50°C
Grado di Protezione IP / IP protection class	30	30	30	30
Soft START / Soft STOP	Si / Yes	Si / Yes	Si / Yes	Si / Yes
Assorbimento di corrente / Current draw	0,4 A	1 A	0,4 A	1 A
Potenza assorbita	42 W	24 W	42 W	24 W
Rilevamento Ostacolo / Obstacle detection	Assorbimento di corrente <i>Current draw</i>	Assorbimento di corrente <i>Current draw</i>	Assorbimento di corrente <i>Current draw</i>	Assorbimento di corrente <i>Current draw</i>
Collegamento in parallelo <i>Connection in parallel</i>	Si / Yes Max 30 attuatori <i>Max 30 actuators</i>	Si / Yes Max 30 attuatori <i>Max 30 actuators</i>	Si / Yes Max 30 attuatori <i>Max 30 actuators</i>	Si / Yes Max 30 attuatori <i>Max 30 actuators</i>
Sincronizzazione / Synchronisation	No	No	Fino a 8 attuatori <i>Up to 8 actuators</i>	Fino a 8 Attuatori <i>Up to 8 actuators</i>
Dimensioni / Dimensions	26 x 41 x 888 mm	26 x 41 x 888 mm	26 x 41 x 888 mm	26 x 41 x 888 mm
Finecorsa in apertura / Open limit switch	Encoder	Encoder	Encoder	Encoder
Finecorsa in chiusura / Closed limit switch	Amperometrica	Amperometrica	Amperometrica	Amperometrica
Peso Attuatore / Actuator weight	1,90 Kg	1,90 Kg	1,90 Kg	1,90 Kg

* Vedi grafici portate attuatori pag. 98-99 / See actuators graph pag. 98-99

Catena Chain

La qualità elevata e la robustezza della catena inox a doppia maglia garantiscono la trasmissione della forza massima sia in trazione che in spinta.

The high quality and sturdiness of the double link stainless steel chain guarantee the transmission of the maximum force both in traction and in thrust.

IQ Interconnectivity IQ Interconnectivity

L'interconnettività IQ è un innovativo sistema di comunicazione wireless. Grazie al dispositivo Wi-Fi posto all'interno del motore è possibile connettersi con l'app MOWIN per una completa configurazione degli attuatori e garantisce una perfetta sincronizzazione tra più attuatori installati sulla stessa finestra.

IQ interconnectivity is an innovative wireless communication system. Thanks to the Wi-Fi device placed inside the motor, it allows you to connect with the MOWIN app for complete configuration of the actuators and guarantee perfect synchronization between multiple actuators installed on the same window.

Diagnostica Diagnostics

La Mowin App consente sia la registrazione delle ultime manovre con le eventuali anomalie segnalate, sia di effettuare una diagnostica in tempo reale per individuare eventuali errori di malfunzionamento.

L'attuatore è anche dotato di un led in grado di segnalare se ci sono eventuali anomalie.

The Mowin App allows both the recording of the last manoeuvres with any reported anomalies and real-time diagnostics to identify any malfunction errors. The actuator is also equipped with a led able to signal if there are any anomalies.

LIWIN L40 Slim - 1000

LIWIN L40 Slim - 1000 Wi-Fi

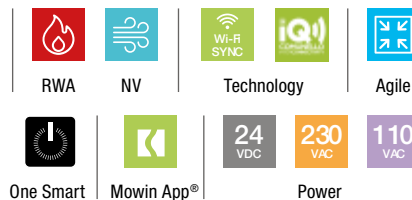

Configurazione dell'attuatore

Actuator configuration



Sporgere
Top hung

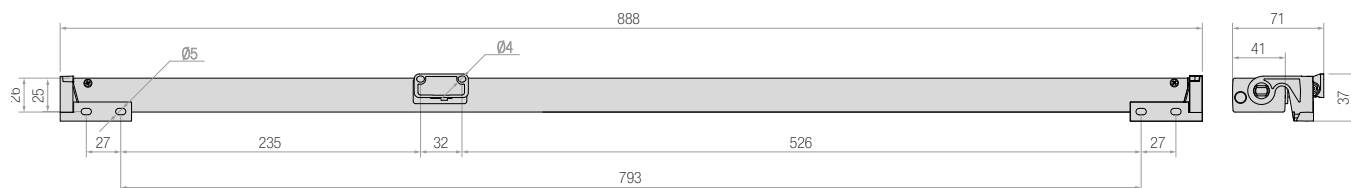

L40 Slim - 1000 - Angolo di apertura anta a sporgere
L40 Slim - 1000 - Top hung opening angle

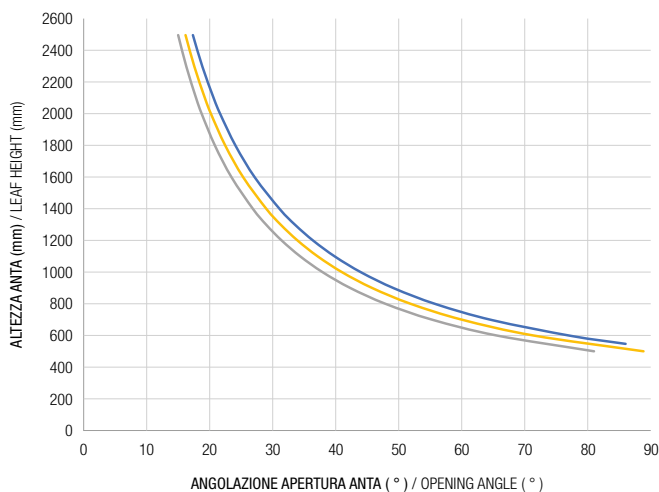

CORSA / STROKE — 650 mm — 700 mm — 750 mm

L40 Slim - 1000 - Portate attuatori a sporgere
L40 Slim - 1000 - Actuator force - top hung

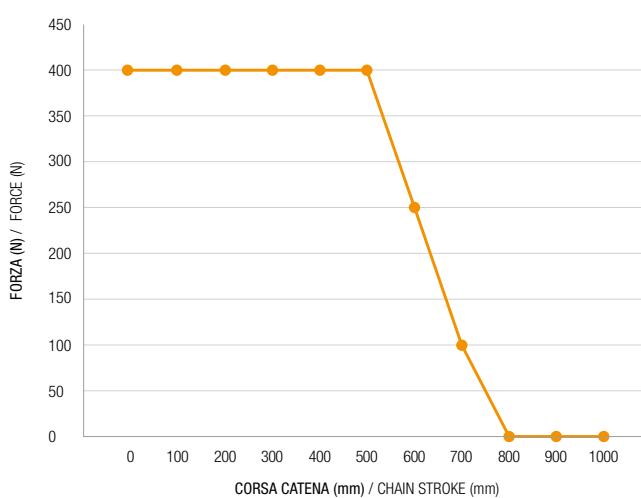

— SPORGERE / TOP HUNG OUTWARD OPENING

I valori indicati nei grafici sono da considerarsi indicativi e non considerano eventuali deformazioni dovute a fattori esterni.
The values indicated in the graphs are to be considered indicative and do not consider any deformations due to external factors.

Per scegliere l'attuatore Comunello Mowin più adatto, è necessario calcolare la FORZA (F) necessaria a sostenere il movimento della finestra. Il tipo di attuatore va selezionato considerando la combinazione tra la dimensione di BASE del serramento e la forza calcolata (N).

Per ante con BASE superiore a 1.5 metri, se il serramento è sufficientemente rigido, consigliamo l'installazione di sistemi sincronizzati come illustrato nel paragrafo Sincronizzazione di p.28.

In order to choose the most suitable Comunello Mowin actuator, you have to calculate the necessary FORCE (F) to sustain the window movement. Choose the actuator type in accordance with the CALCULATED FORCE (N) and the FRAME DIMENSION.

For leaves with a BASE greater than 1.5 metres, if the window is sufficiently rigid, we recommend the installation of synchronized systems as illustrated in the Synchronization paragraph on p.28.

Vasistas
Bottom hung

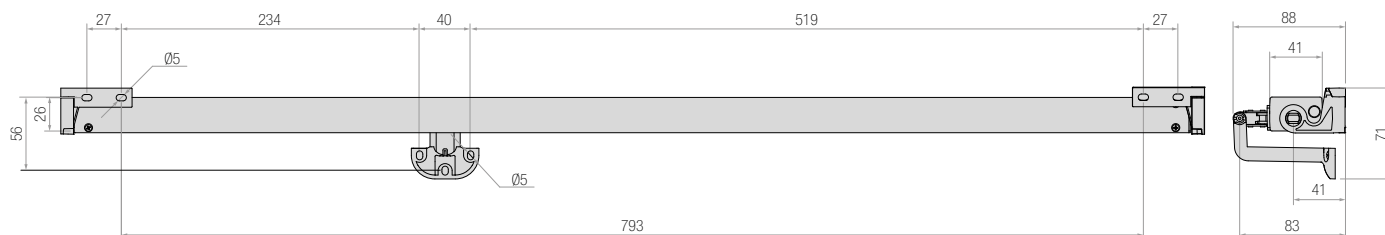

L40 Slim - 1000 - Angolo di apertura anta vasistas
L40 Slim - 1000 - Bottom hung opening angle

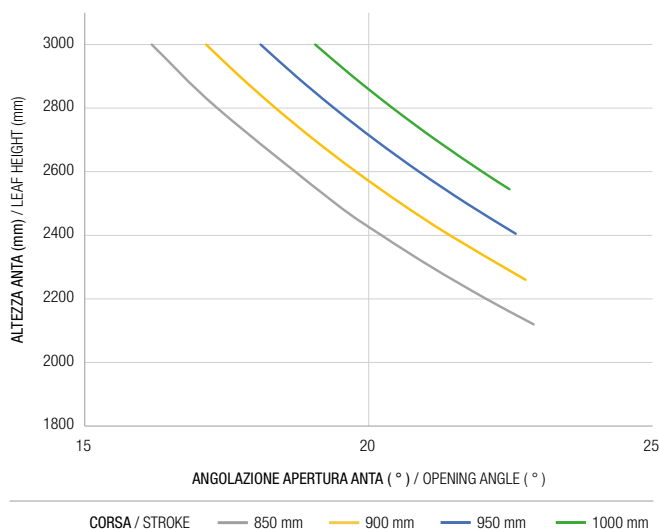

L40 Slim - 1000 - Portate attuatori vasistas
L40 Slim - 1000 - Actuator force - bottom hung

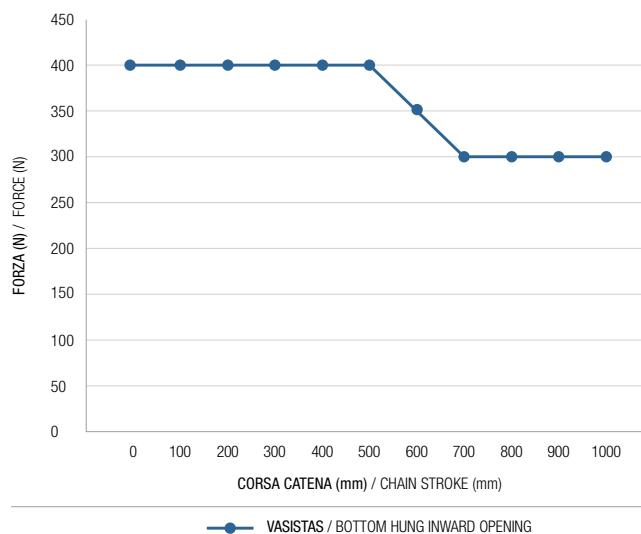

I valori indicati nei grafici sono da considerarsi indicativi e non considerano eventuali deformazioni dovute a fattori esterni.
The values indicated in the graphs are to be considered indicative and do not consider any deformations due to external factors.

Formule per il calcolo della forza necessaria a movimentare il serramento Formulas for calculating the force necessary to move the window

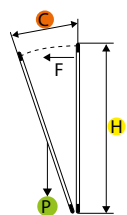

$$\frac{C \div H}{2} \times P = F \text{ Kg}$$

$$F \text{ (Kg)} \times 9,8 = \mathbf{N F \text{ (N)}}$$

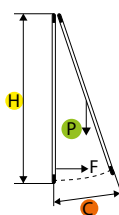

$$\frac{C \div H}{2} \times P = F \text{ Kg}$$

$$F \text{ (Kg)} \times 9,8 = \mathbf{N F \text{ (N)}}$$

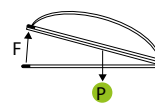

$$P \div 2 = F \text{ Kg}$$

$$F \text{ (Kg)} \times 9,8 = \mathbf{N F \text{ (N)}}$$

F = Forza necessaria
Necessary Force (Kg)

C = Corsa di apertura
Opening stroke (mm)









H = Altezza serramento
Window height (mm)

P = Peso serramento
Window weight (Kg)

LIWIN L40 Slim - 1000





LIWIN L40 Slim - 1000 Wi-Fi



Article	Commercial code	Product code	Push / pull*	Strokes	Colour	Power supply	Weight	Pcs
LIWIN L40 Slim	L40 SLIM 230V - 1000	 ML4S S VN NW 10H AL00 I	400 N	850 - 900 - 950 - 1000	GRIGIO / Grey 	110/230VAC	1,90 kg	1
LIWIN L40 Slim	L40 SLIM RWA - 1000	 ML4S S RW NW 10L AL00 I	400 N	850 - 900 - 950 - 1000	GRIGIO / Grey 	24VDC	1,90 kg	1
LIWIN L40 Slim Wi-Fi	L40 SLIM 230V-WF - 1000	 ML4S S VN WF 10H AL00 I	400 N	850 - 900 - 950 - 1000	GRIGIO / Grey 	110/230VAC	1,90 kg	1
LIWIN L40 Slim Wi-Fi	L40 SLIM RWA-WF - 1000	 ML4S S RW WF 10L AL00 I	400 N	850 - 900 - 950 - 1000	GRIGIO / Grey 	24VDC	1,90 kg	1

*Vedi grafici portate attuatori p.98-99 / *See actuators graph p.98-99

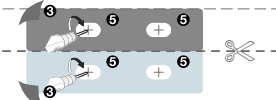
La confezione contiene - Box contains:

	<p>Attuatore (staffe escluse) Actuator (brackets excluded)</p> 	<p>Dima per l'installazione Mounting template</p> 	<p>Manuale d'uso User manual</p>	
---	--	--	--------------------------------------	---



Block

Serratura elettromeccanica in alluminio pressofuso per la movimentazione della ferramenta interna di una finestra. Può essere utilizzata in un sistema sincronizzato con gli attuatori Comunello.

Electromechanical lock in die-cast aluminium for moving the internal hardware of a window. It can be used in a system synchronized with Comunello actuators.

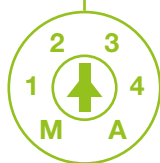
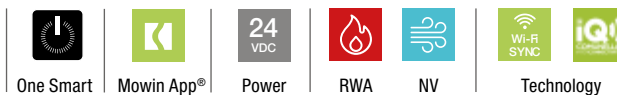

Trimmer

Posizione M: Stato attuatore SLAVE
 Posizioni 1-2-3-4: Impostazione corsa: 19-19-34-36 mm.
 Posizione A: Wi-Fi attivo - MASTER.

Trimmer

Posizione M: Slave actuator status
 Positions 1-2-3-4: Chain setting: 19-19-34-36 mm.
 Position A: Wi-Fi active - MASTER.

Caratteristiche principali

Main features

Regolazione

Adjustment

Regolazione: Mediante il trimmer dedicato è possibile regolare la corsa per armare e disarmare la ferramenta.

Adjustment: Using the dedicated trimmer it is possible to adjust the stroke to arm and disarm the hardware.

IQ Interconnectivity

IQ Interconnectivity

L'interconnettività IQ è un innovativo sistema di comunicazione wireless. Grazie al dispositivo Wi-Fi posto all'interno del motore è possibile connettersi con l'app MOWIN per una completa configurazione degli attuatori e garantisce una perfetta sincronizzazione tra più attuatori installati sulla stessa finestra.

IQ interconnectivity is an innovative wireless communication system. Thanks to the Wi-Fi device placed inside the motor, it allows you to connect with the MOWIN app for complete configuration of the actuators and guarantee perfect synchronization between multiple actuators installed on the same window.



Resistenza

Resistance

L'involucro in alluminio pressofuso garantisce un'elevata resistenza anche in ambienti particolarmente difficili. Il sistema Block ha superato tutti i test di resistenza al calore previsti dalla normativa EN 12101-2.

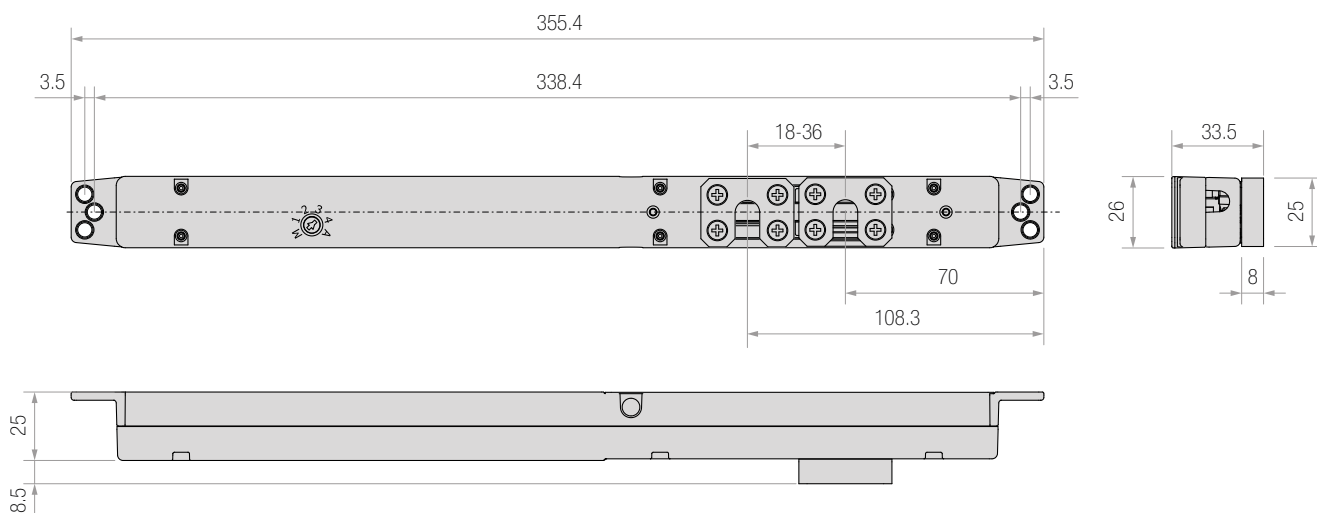
The die-cast aluminum casing guarantees high resistance even in particularly difficult environments. The Block system has passed all the heat resistance tests required by the EN 12101-2 standard.



Article	Commercial code	Product code	Strokes	Colour	Power supply	Weight	Pcs
BLOCK SYSTEM	BLOCK 24V-WF	 MBLK S RW WF XXL AL00 Z	19-19-34-36	GRIGIO / Grey 	24VDC		1

La confezione contiene - Box contains:			
	Attuatore <i>Actuator</i>	Istruzioni per montaggio - Manuale d'uso. <i>Mounting instructions</i> - User manual.	



→ Centrale evacuazione fumo e calore

Smoke and heat ventilation control unit



1.



CU RWA 4A
Centrale RWA 4 Ampere
RWA control unit - 4 Amp

cod. MX00 AU 4A L 0W 00

2.



CU RWA 8A
Centrale RWA 8 Ampere
RWA control unit - 8 Amp

cod. MX00 AU 8A L 0W 00

3.



CU RWA 32A
Centrale RWA 32 Ampere
RWA control unit - 32 Amp

cod. MX00 AU 32 L 0W 00

4.



Rilevatore di pioggia
Rain sensor

cod. MX00 AR 01 N 0G 00

5.

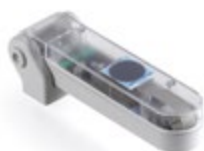

Rilevatore di pioggia trasparente
Transparent rain sensor

cod. MX00 AR 01 N 0T 00

6.



Rilevatore fumo
Smoke sensor

cod. MX00 SD 00 L 0W 00

7.



Rilevatore calore
Heat sensor

cod. MX00 HD 00 L 0W 00

8.



Pulsante di emergenza
Fire alarm

cod. MX00 EB 00 L 0A 00

9.



Rilevatore vento per centrale RWA
RWA wind sensor

cod. MX00 AR 05 L 0W 00

10.



Interfaccia rilevatore vento per centrale RWA
RWA interface for wind sensor

cod. MX00 AU 03 N 0B 00

Attuatori compatibili / Compatible actuator



LIWIN L40



LIWIN L40 SLIM 350



LIWIN L40 SLIM 600



LIWIN L40 SLIM 800



LIWIN L40 SLIM 1000



BLOCK



Schema collegamento Centralina Rwa, attuatori e accessori

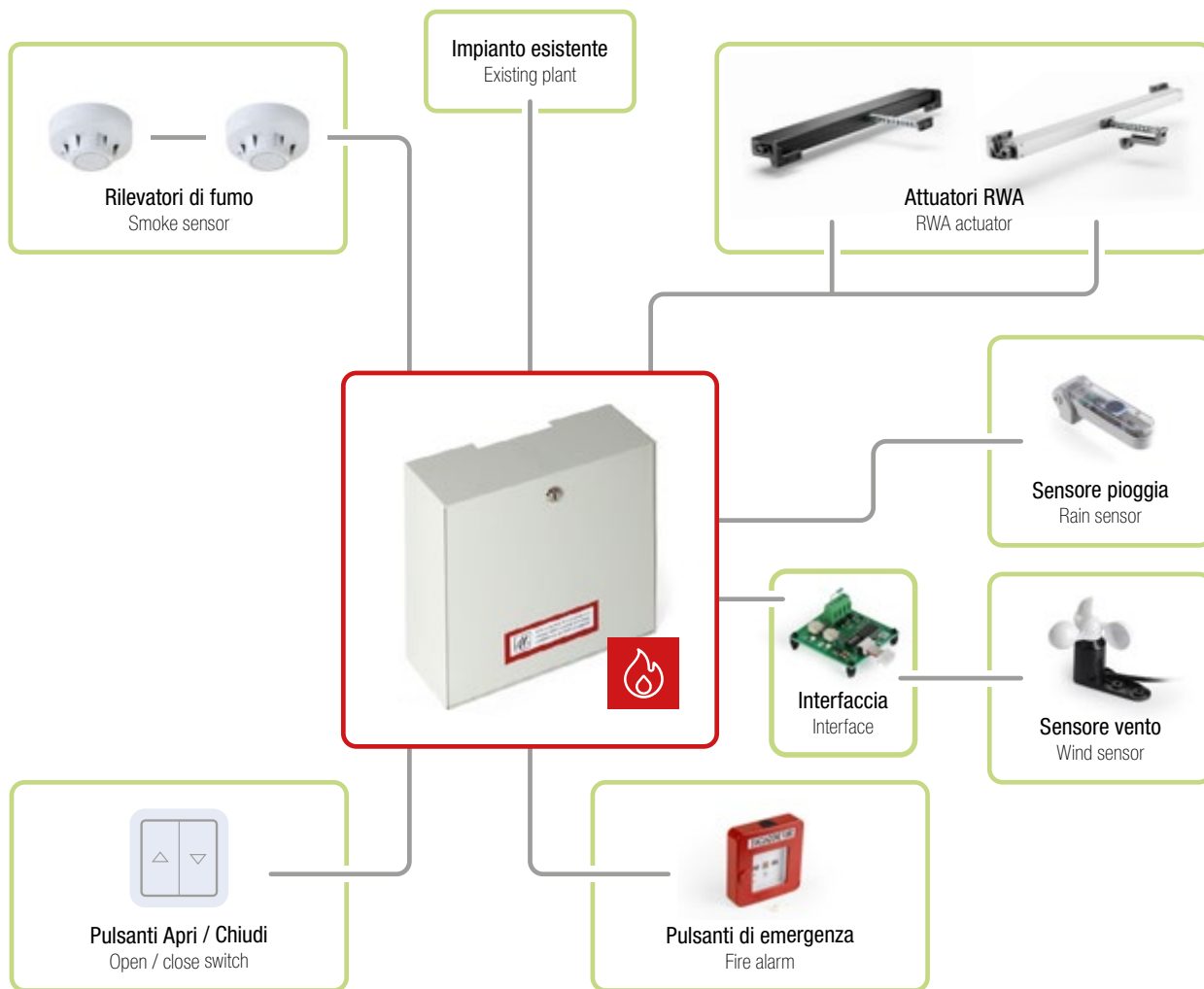

→ Accessori RWA

RWA accessories



Gli alimentatori, disponibili nelle versioni per attuatori 24VDC e 230VAC, sono dispositivi a portata di mano che permettono di alimentare gli attuatori Mowin di Comunello. È sufficiente infatti seguire i collegamenti secondo lo schema seguente per poter effettuare una sincronizzazione di più attuatori, fare una diagnostica real time o regolare i parametri principali degli attuatori. Oltre ai comandi di apertura e chiusura, premendo il pulsante POWER è possibile mantenere alimentati gli attuatori per interagire con la Mowin App.

The power supplies, available in the versions for 24VDC and 230VAC actuators, are handy devices that allow you to power the Comunello Mowin actuators. In fact, it is sufficient to follow the connections according to the following diagram to be able to carry out a synchronization of more actuators, perform real-time diagnostics or adjust the main parameters of the actuators. In addition to the opening and closing commands, by pressing the POWER button it is possible to keep the actuators powered to interact with the Mowin App.



AF-920

Alimentatore da banco 24 VDC
Bench tester 24 VDC

cod. MX00AU04L0B00



AF-910

Alimentatore da banco 230 VAC
Bench tester 230 VAC

cod. MX00AU04H0B00

Attuatori compatibili / Compatible actuators



STAFFE ATTUATORI RWA						
Product photo	Commercial code	Product code	Colour	Attuatori compatibili	Weight	PCS
	Staffe di supporto AGILE	MX00 AS 40 N OW 00	BIANCO / White <input type="checkbox"/>	L40	1,35 Kg	10
	Staffe di supporto AGILE	MX00 AS 40 N OB 00	NERO / Black <input checked="" type="checkbox"/>	L40	1,35 Kg	10
	Staffe di supporto AGILE	MX00 AS 40 N OG 00	GRIGIO / Grey <input checked="" type="checkbox"/>	L40 e L40 SLIM	1,35 Kg	10
	Attacco per finestre a sporgere	MX00 SP 40 N OW 00	BIANCO / White <input type="checkbox"/>	L40	0,69 Kg	30
	Attacco per finestre a sporgere	MX00 SP 40 N OB 00	NERO / Black <input checked="" type="checkbox"/>	L40	0,69 Kg	30
	Attacco per finestre a sporgere	MX00 SP 40 N OG 00	GRIGIO / Grey <input checked="" type="checkbox"/>	L40 e L40 SLIM	0,69 Kg	30
	Attacco per finestre a visistas	MX00 VA 40 N OW 00	BIANCO / White <input type="checkbox"/>	L40	3,36 Kg	30
	Attacco per finestre a visistas	MX00 VA 40 N OB 00	NERO / Black <input checked="" type="checkbox"/>	L40	3,36 Kg	30
	attacco per finestre a visistas	MX00 VA 40 N OG 00	GRIGIO / Grey <input checked="" type="checkbox"/>	L40 e L40 SLIM	3,36 Kg	30
	Staffa di support per abbaino	MX00 SA 35 NO W00	BIANCO / White <input type="checkbox"/>	L40 L40 SLIM L35 L35 SLIM	0,19 Kg	10
	Staffa di support per abbaino	MX00 SA 35 NO B00	NERO / Black <input checked="" type="checkbox"/>	L40 L40 SLIM L35 L35 SLIM	0,19 Kg	10
	Staffa di support per abbaino	MX00 SA 35N OG 00	GRIGIO / Grey <input checked="" type="checkbox"/>	L40 L40 SLIM L35 L35 SLIM	0,19 Kg	10



Schema collegamento alimentatore MX00AU04L0B00 per attuatori 24 VDC / MX00AU04L0B00 power supply connection diagram for 24VDC actuators

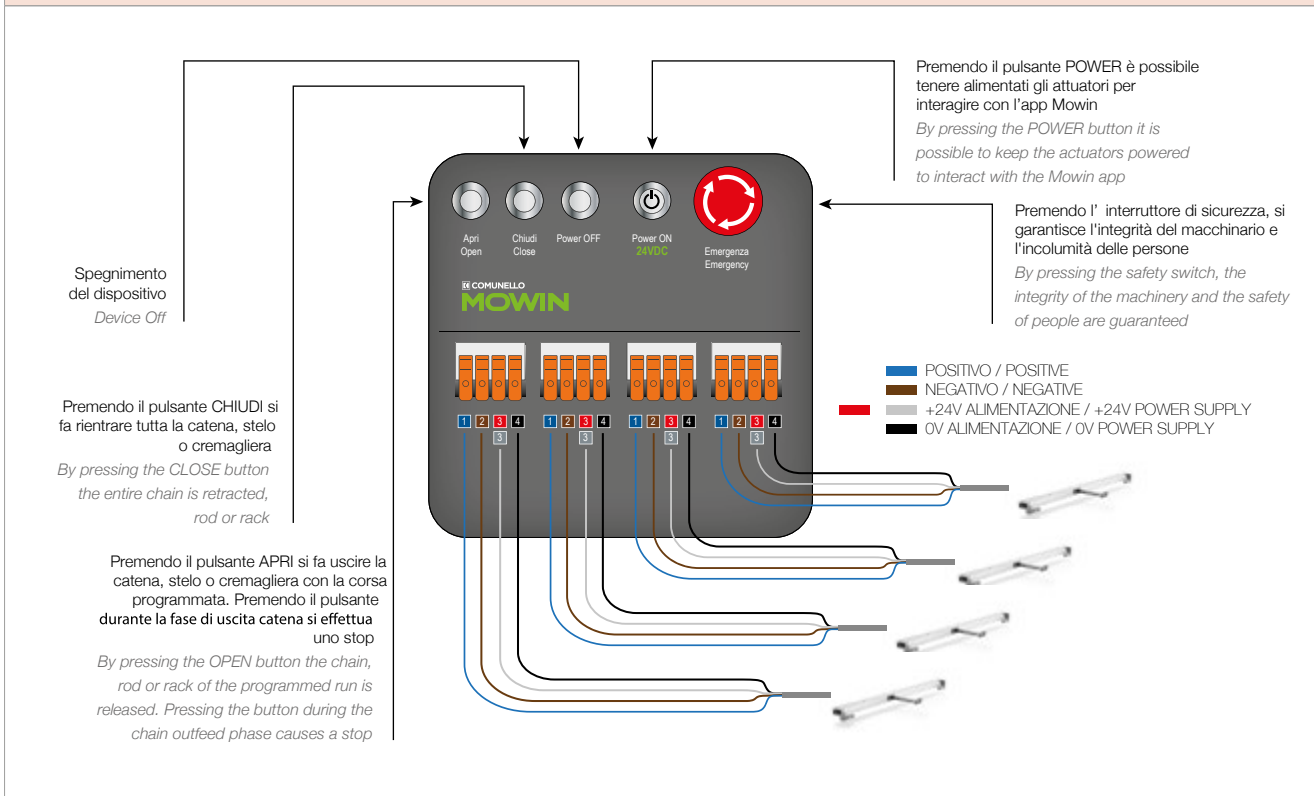

Schema collegamento alimentatore MX00AU04H0B00 per attuatori 230 VAC / MX00AU04H0B00 power supply connection diagram for 230 VAC actuators

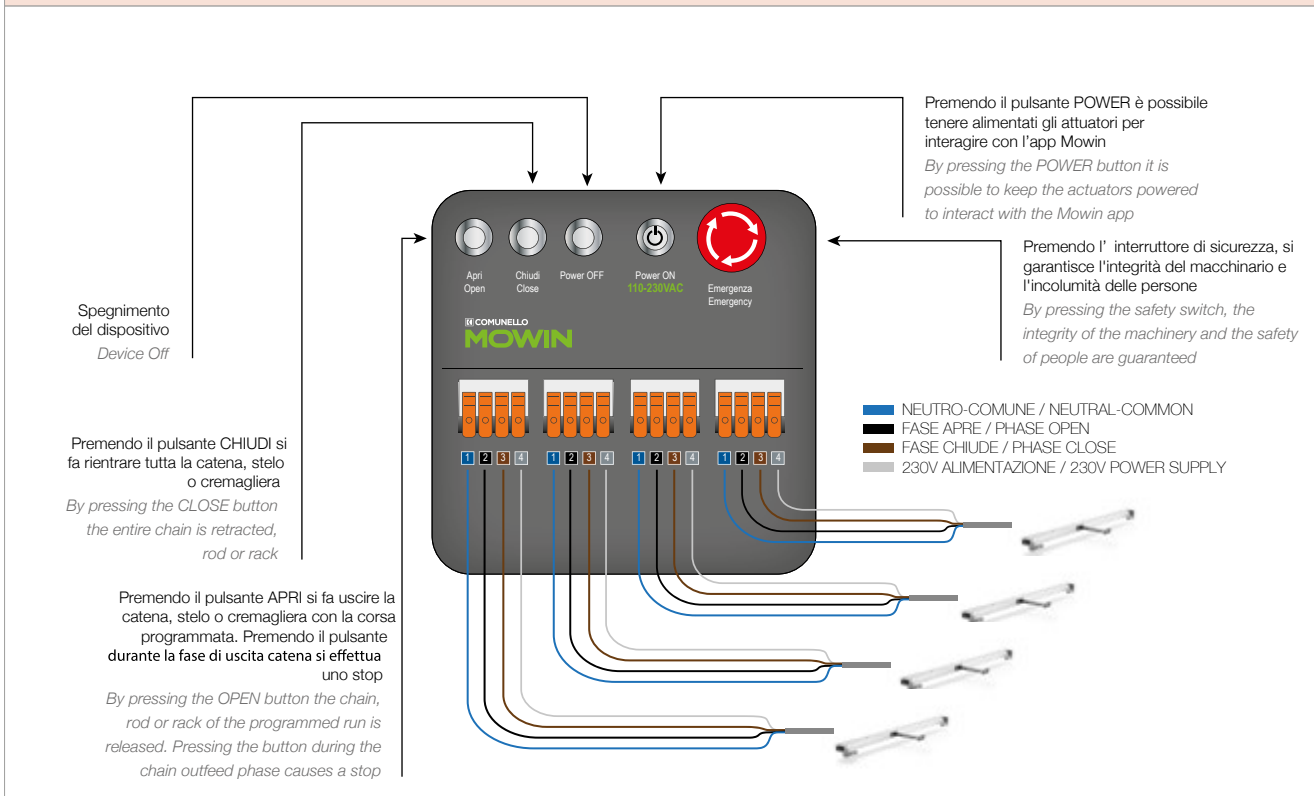

→ Smart home accessori

Smart home accessories



AF-800
Centrale di comando 110-240 V
Control unit 110-240 V

cod. MX00 AU 05 H 0W 00



AF-820
Centrale di comando
110-240 V Wi-Fi
Control unit 110-240 V Wi-Fi

cod. MX00 AU 06 H 0W 00



AF-840
Centrale di comando 110-240V
Control unit 110-240V

cod. MX00 AU 07 H 0W 00



AF-850
Centrale di comando
110-240 V Wi-Fi
Control unit 110-240 V Wi-Fi

cod. MX00 AU 08 H 0W 00



AF-860
Centrale di comando
12-24 VAC/DC Wi-Fi
Control unit 12-24 VAC/DC Wi-Fi

cod. MX00 AU 09 L 0W 00



AF-880
Radiocomando Rolling 1
Radiocomando 1 canale
Remote control 1 channel

cod. MX00 AT 11 N 0B 00



AF-890
Radiocomando Rolling 6
Radiocomando 6 canali
Remote control 6 channels

cod. MX00 AT 16 N 0B 00



AF-870
Pulsante radio Rolling
Radiocomando 1 canale
Remote control 1 channel

cod. MX00 AT 10 N 0W 00



Rilevatore vento sole
Wind sun sensor

cod. MX00 AR 02 N 0T 00



Rilevatore di pioggia
Rain sensor

cod. MX00 AR 01 N 0T 00

Attuatori compatibili / Compatible actuators



LIWIN L40 / L40
SLIM



BLOCK



SMART



STAR



LIWIN L20 / L35



FAST



RAYWIN



AIRWIN



Sensori di pioggia e vento/sole.
Rain and wind/sun sensors.



Centrale di comando a scomparsa per controllo finestre e tapparelle motorizzate.
Concealed control unit for controlling motorized windows and rolling shutters.



Attivatore tramite pulsante radio Rolling.
Activator via Rolling radio button.



Assistente vocale di comando per la gestione dei dispositivi OneSmart tramite voce.
Command voice assistant for managing OneSmart devices via voice.



Radiocomando multi-canale per il controllo di finestre e tapparelle.
Multi-channel remote control for controlling windows and shutters.



Controllo remoto con Smartphone tramite connessione Wi-Fi.
Remote control with Smartphone via Wi-Fi connection.



→ Ventilazione Naturale

Natural ventilation



La ventilazione naturale svolge un ruolo fondamentale per la qualità della vita di tutti noi. Avere la possibilità di arieggiare i locali, anche per brevi periodi, consente di far uscire l'aria viziata, ricca di vapore e di anidride carbonica e sostituirla con aria fresca e pulita. Ne derivano vantaggi innanzitutto dal punto di vista della salute di chi ci abita ma si evita inoltre la formazione di muffe all'interno delle stanze.

Natural ventilation plays a fundamental role in the quality of life of all of us. Having the possibility of airing the rooms, even for short periods, allows the stale air, rich in vapor and carbon dioxide, to be let out and replaced with fresh, clean air. This results in advantages above all from the point of view of the health of those who live there, but the formation of mold inside the rooms is also avoided.





→ Ventilazione Naturale

Natural ventilation



Consideriamo l'automazione un passaggio naturale ed obbligato per accedere alle logiche del nuovo concetto dell'abitare. Un gesto liberatorio. Con le aperture che non devono più necessariamente essere raggiungibili dall'operatore meccanico si schiudono nuove possibilità all'architettura sia in termini di creatività che di intelligenza e razionalità delle soluzioni. Porte e finestre si trovano nelle ubicazioni ideali per benessere ed estetica. Nelle loro forme e strutture sono libere da condizionamenti, ubbidiscono solo agli ordini di un elegante e semplice radiocomando. Massimo relax, minimo sforzo, equilibri perfetti di luce ed ventilazione.

Con la nuova serie MOWIN, Comunello è in grado di fornire attuatori che abbinano un design curato a dimensioni contenute adatte ad applicazioni sempre più frequenti con spazio di installazione ridotto.

We consider automation a natural and obligatory passage to access the logic of the new concept of living. A liberating gesture. With the openings that no longer necessarily have to be reached by the mechanical operator, new possibilities are opening up for architecture both in terms of creativity and intelligence and rationality of the solutions. Doors and windows are located in the ideal locations for well-being and aesthetics. In their shapes and structures they are free from conditioning, they only obey the orders of an elegant and simple remote control. Maximum relaxation, minimum effort, perfect balance of light and ventilation.

With the new MOWIN series, Comunello is able to supply actuators that combine fine design with small dimensions suitable for increasingly frequent applications with reduced installation space.

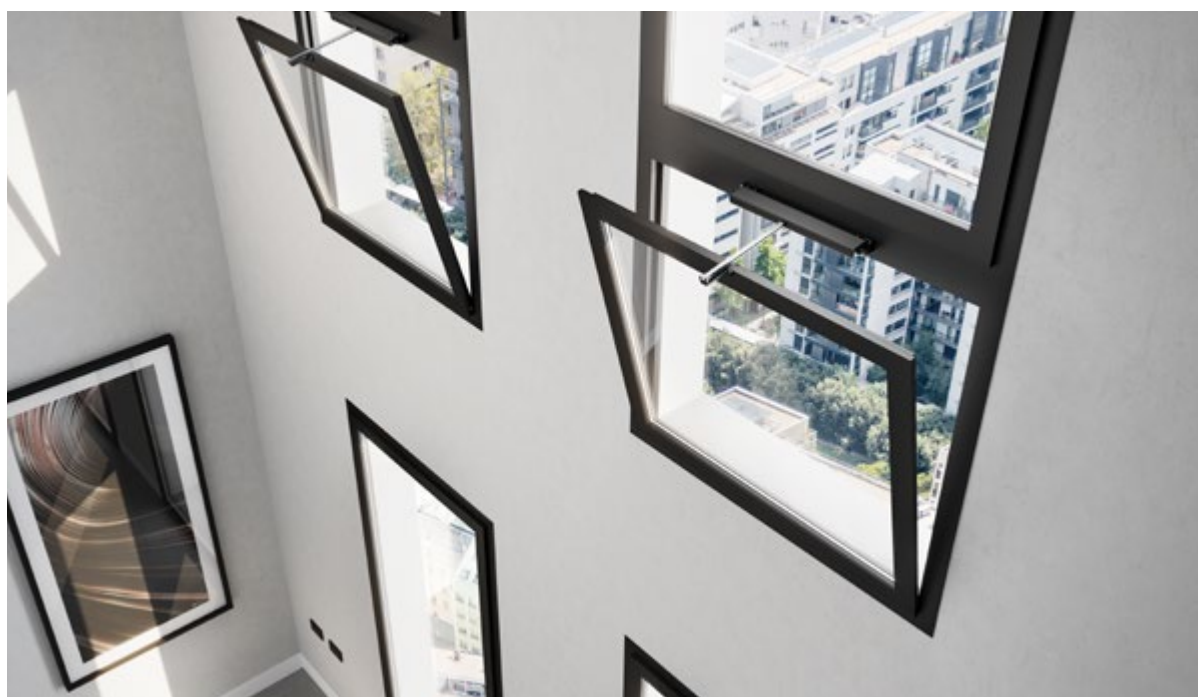



2



SMART



p. 114

Attuatore a catena per apertura e chiusura di finestre in legno, PVC, alluminio e acciaio. Adatto ad aperture a vasistas, sporgere, shed e lucernai.

Chain actuator for opening and closing wooden, PVC, aluminum and steel windows. Suitable for bottom-hung, protruding, shed and skylights.

NV 24 V
110 V /230 V



STAR 25



p. 124

Attuatore a catena per apertura e chiusura di finestre in legno, PVC, alluminio e acciaio. Adatto ad aperture a vasistas, sporgere, shed, lucernai e cupolini.

Chain actuator for opening and closing wooden, PVC, aluminum and steel windows. Suitable for bottom-hung, protruding, shed, skylights and small domes.

NV 24 V
110 V /230 V



STAR 30



p. 134

Attuatore a catena per apertura e chiusura di finestre in legno, PVC, alluminio e acciaio. Adatto ad aperture a vasistas, sporgere, shed e lucernai.

Chain actuator for opening and closing wooden, PVC, aluminum and steel windows. Suitable for bottom-hung, protruding, shed and skylights.

NV 24 V /230 V



FAST



p. 144

Attuatore a stelo per apertura e chiusura di finestre in legno, PVC, alluminio e acciaio. Adatto ad aperture a sporgere, lucernai, shed cupole e pale frangisole.

Spindle actuator for opening and closing wooden, PVC, aluminum and steel windows. Suitable for projecting openings, skylights, shed domes and sunshade blades.

NV 230 V



LIWIN L20 Insert Wi-Fi



p. 152

Attuatore a catena per apertura e chiusura di finestre in legno, PVC, alluminio e acciaio. Adatto ad aperture a vasistas con attuatore esterno o a scomparsa all'interno del profilo.

Chain actuator for opening and closing wooden, PVC, aluminum and steel. Suitable for bottom-hung openings with external actuator or concealed inside the profile.

NV 24 V



LIWIN L35 SLIM



p. 162

Attuatore a catena per apertura e chiusura di finestre in legno, PVC, alluminio e acciaio. Adatto ad aperture a vasistas, sporgere, battente, apertura parallela, shed, lucernai e cupolini.

Chain actuator for opening and closing wooden, PVC, aluminum and steel. Suitable for bottom-hung, projecting, swing, parallel openings, sheds, skylights and small domes.

**NV 24 V
110 V /230 V**



RAYWIN



p. 172

Attuatore a stelo per apertura e chiusura di finestre in legno, PVC, alluminio e acciaio. Adatto ad aperture a sporgere, lucernai, shed cupole e pale frangisole.

Spindle actuator for opening and closing wooden, PVC, aluminum and steel windows. Suitable for projecting openings, skylights, shed domes and sunshade blades.

**NV 24 V
110 V /230 V**



AIRWIN



p. 192

Attuatore a cremagliera per apertura e chiusura di finestre in legno, PVC, alluminio e acciaio. Adatto ad aperture a sporgere, lucernai, shed cupole e pale frangisole.

Rack actuator for opening and closing wooden, PVC, aluminum and steel windows. Suitable for projecting openings, skylights, shed domes and sunshade blades.

**NV 24 V
110 V /230 V**



Smart



Attuatore elettromeccanico modello SMART 20 con catena articolata a doppia maglia e spessore maggiorato. Disponibile nelle versioni 110-230VAC e 24VDC. Sistema di finecorsa elettronico in apertura e ad assorbimento di corrente in chiusura. Corse disponibili 180-380mm facilmente regolabili mediante dip-switch anche a motore non alimentato. Collegabile in parallelo. È possibile l'installazione di due SMART 230VAC nello stesso serramento mediante l'utilizzo della scheda AF 960.

SMART 20 model electromechanical actuator with double-link articulated chain and increased thickness. Available in 230VAC and 24VDC versions. Electronic limit switch system in opening and current absorption in closing. Available strokes 180-380mm easily adjustable by dip-switch even when the motor is not powered. Can be connected in parallel. It is possible to install two SMART 230VAC in the same window using the AF 960 board.





Smart



Attuatore a catena per apertura e chiusura di finestre in legno, PVC, alluminio e acciaio. Adatto ad aperture a vasistas, sporgere, shed e lucernai.

Chain actuator for opening and closing wooden, PVC, aluminum and steel windows. Suitable for bottom-hung, projecting, shed and skylight openings.





Smart

24
VDC230
VAC110
VAC

Power

NV



Vasistas
Bottom hung



Sporgere
Top hung



Caratteristiche principali

Main features

Regolabile Adjustable

2 corse facilmente regolabili tramite dip-switch, anche a motore non alimentato.

2 strokes easily adjustable via dip-switch, even when the motor is not powered.

Resistente Resistance

La catena robusta a doppia maglia e a spessore maggiorato garantisce una maggiore resistenza in spinta e in trazione.

The sturdy double-link chain with increased thickness guarantees greater resistance in push and pull.

Affidabile Reliable

Le staffe di supporto consentono l'oscillazione dell'attuatore per accompagnare il movimento della finestra.

The support brackets allow the actuator to swing to accompany the movement of the window.

Finecorsa Limit switch

Apprendimento del finecorsa in chiusura automatico per assorbimento di corrente. In questo modo è garantita una chiusura sicura e costante nel tempo.

Acquisition of the automatic closing limit switch by current absorption. In this way, a safe and constant closure over time is guaranteed.

Caratteristiche tecniche / Technical data sheet

	SMART 20 - 230 V	SMART 20 - 24 V
Forza Trazione / <i>Traction force</i>	250 N	250 N
Forza Spinta / <i>Thrust force</i>	200 N	200 N
Alimentazione / <i>Power supply</i>	110/230 VAC	24 VDC
Frequenza / <i>Frequency</i>	50/60 Hz	-
Tipo di servizio / <i>Type of service</i>	s2 4min	s2 4min
Velocità a vuoto / <i>Unloaded stroke speed</i>	16 mm/s	16 mm/s
Corse disponibili / <i>Strokes available</i>	180 - 380	180 - 380
Temperatura di funzionamento / <i>Operating temperature</i>	-5°C + 50°C	-5°C + 50°C
Grado di protezione IP / <i>IP protection class</i>	20	20
Soft START / Soft STOP	Si / Yes	Si / Yes
Assorbimento corrente / <i>Current draw</i>	0,14 A	0,9 A
Potenza assorbita / <i>Power draw</i>	22 W	22 W
Rilevamento ostacolo / <i>Obstacle detection</i>	Si / Yes	Si / Yes
Collegamento in parallelo / <i>Connection in parallel</i>	Max 30 Attuatori <i>Max 30 actuators</i>	Max 30 Attuatori <i>Max 30 actuators</i>
Sincronizzazione / <i>Synchronisation</i>	No	No
Dimensioni / <i>Dimensions</i>	41 X 79 X 265 mm	41 X 79 X 265 mm
Finecorsa in apertura / <i>Open limit switch</i>	Sensore / <i>Sensor</i>	Sensore / <i>Sensor</i>
Finecorsa in chiusura / <i>Closed limit switch</i>	Amperometrica / <i>Amperometric</i>	Amperometrica / <i>Amperometric</i>
Peso attuatore / <i>Actuator weight</i>	1,10 Kg	1,10 Kg

Installazione**Installation**

Installazione facile e veloce grazie all'aggancio rapido delle staffe.

Quick and easy installation thanks to the quick coupling of the brackets.

Completo**Complete**

L'attuatore SMART è completo di staffe ed attacchi catena sia per applicazioni a vasistas che a sporgere.

The SMART actuator is complete with brackets and chain attachments for both bottom-hung and top-hung applications.

Kit smart twin

È disponibile il KIT SMART TWIN composto da 2 attuatori ed interfaccia AF-960 da installare in un'unica finestra.

The SMART TWIN KIT is available, consisting of 2 actuators and AF-960 interface to be installed in a single window.

24
VDC230
VAC110
VAC

One Smart

Power

NV

Configurazione dell'attuatore

Actuator configuration



Sporgere
Top hung

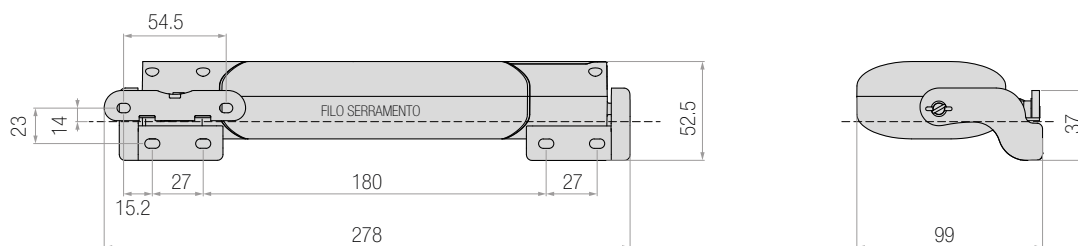

SMART - Angolo di apertura anta a sporgere

SMART - Top hung opening angle

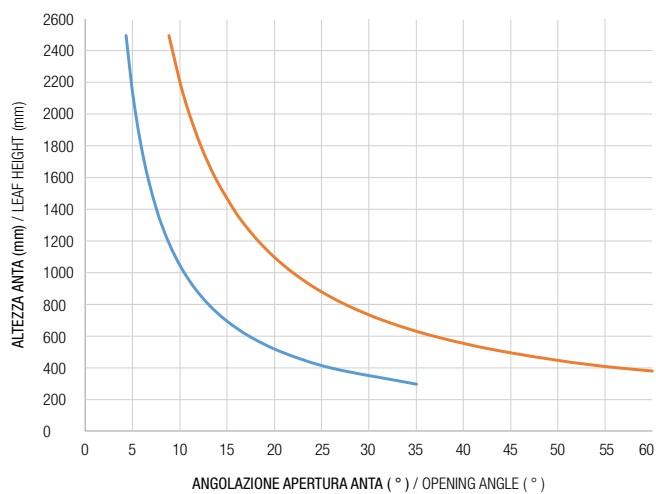

CORSA / STROKE — 180 mm — 380 mm

SMART - Portate attuatori a sporgere

SMART - Actuator force - top hung

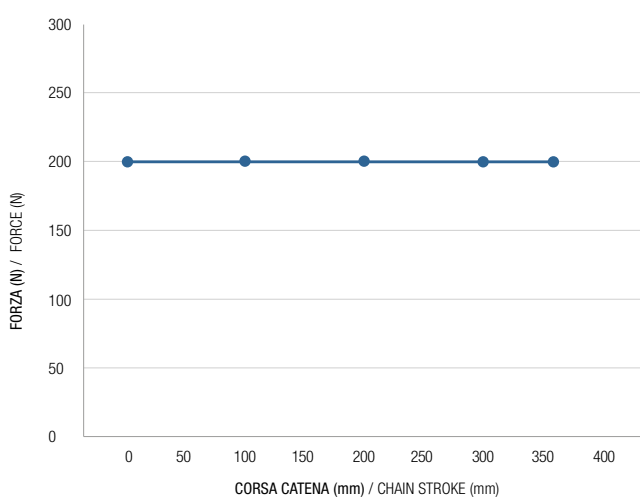

—●— SPORGERE / TOP HUNG OUTWARD OPENING ABBAINO / DORMER

I valori indicati nei grafici sono da considerarsi indicativi e non considerano eventuali deformazioni dovute a fattori esterni.
The values indicated in the graphs are to be considered indicative and do not consider any deformations due to external factors.

Per scegliere l'attuatore Comunello Mowin più adatto, è necessario calcolare la FORZA (F) necessaria a sostenere il movimento della finestra. Il tipo di attuatore va selezionato considerando la combinazione tra la dimensione di BASE del serramento e la forza calcolata (N).

In order to choose the most suitable Comunello Mowin actuator, you have to calculate the necessary FORCE (F) to sustain the window movement. Choose the actuator type in accordance with the CALCULATED FORCE (N) and the FRAME DIMENSION.

Vasistas
Bottom hung

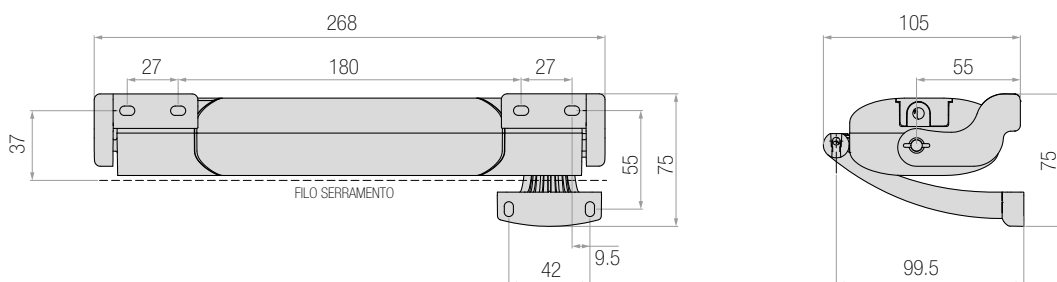

SMART - Angolo di apertura anta vasistas
SMART - Bottom hung opening angle

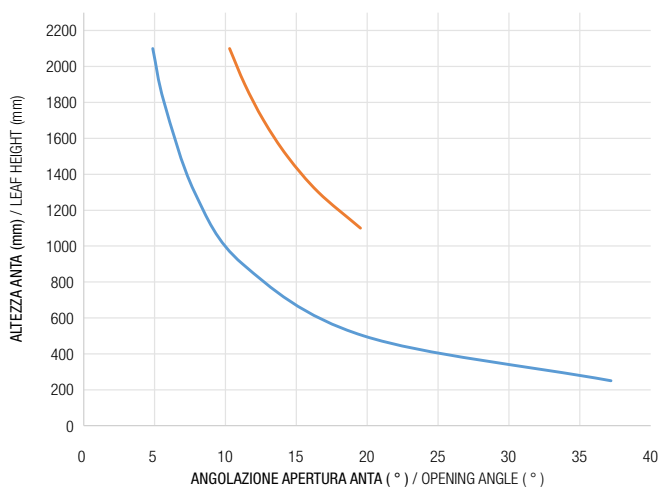

CORSA / STROKE — 180 mm — 380 mm

SMART - Portate attuatori vasistas
SMART - Actuator force - bottom hung

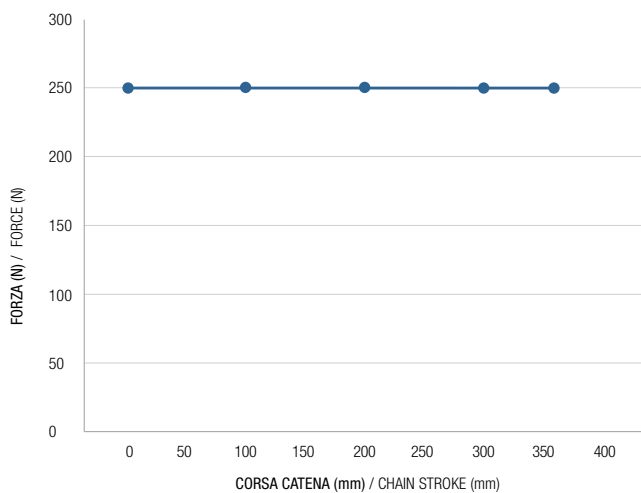

— VASISTAS / BOTTOM HUNG INWARD OPENING

I valori indicati nei grafici sono da considerarsi indicativi e non considerano eventuali deformazioni dovute a fattori esterni.
The values indicated in the graphs are to be considered indicative and do not consider any deformations due to external factors.

Formule per il calcolo della forza necessaria a movimentare il serramento *Formulas for calculating the force necessary to move the window*

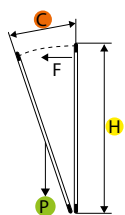

$$\frac{C \div H}{F} \times (P \div 2) = F \text{ Kg}$$

$$F (\text{Kg}) \times 9,8 = \mathbf{N F (N)}$$

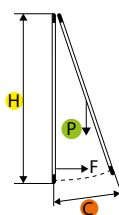

$$\frac{C \div H}{F} \times (P \div 2) = F \text{ Kg}$$

$$F (\text{Kg}) \times 9,8 = \mathbf{N F (N)}$$

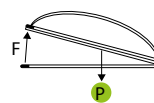

$$P \div 2 = F \text{ Kg}$$

$$F (\text{Kg}) \times 9,8 = \mathbf{N F (N)}$$

F = Forza necessaria
Necessary Force (Kg)

C = Corsa di apertura
Opening stroke (mm)

H = Altezza serramento
Window height (mm)

P = Peso serramento
Window weight (Kg)

Smart

Article	Product code	Push / pull	Strokes	Colour	Power supply	Power	Weight	Pcs
SMART 20 230Vac	MSMART20H0B00	200/250 N	180 - 380 mm	NERO / Black	230 VAC	22W	0,78 kg	1
SMART 20 230Vac	MSMART20H0G00	200/250 N	180 - 380 mm	GRIGIO / Grey	230 VAC	22W	0,78 kg	1
SMART 20 230Vac	MSMART20H0W00	200/250 N	180 - 380 mm	BIANCO / White	230 VAC	22W	0,78 kg	1
SMART 20 110Vac	MSMART20I0B00	200/250 N	180 - 380 mm	NERO / Black	110 VAC	22W	0,78 kg	1
SMART 20 110Vac	MSMART20I0G00	200/250 N	180 - 380 mm	GRIGIO / Grey	110 VAC	22W	0,78 kg	1
SMART 20 110Vac	MSMART20I0W00	200/250 N	180 - 380 mm	BIANCO / White	110 VAC	22W	0,78 kg	1
SMART 20 24Vdc	MSMART20L0B00	200/250 N	180 - 380 mm	NERO / Black	24 VDC	22W	0,78 kg	1
SMART 20 24Vdc	MSMART20L0G00	200/250 N	180 - 380 mm	GRIGIO / Grey	24 VDC	22W	0,78 kg	1
SMART 20 24Vdc	MSMART20L0W00	200/250 N	180 - 380 mm	BIANCO / White	24 VAC	22W	0,78 kg	1

	La confezione contiene:	Box contains:		
	Attuatore <i>Actuator</i>	Staffe Vasistas <i>Vasistas brackets</i>	Staffe Sporgere <i>Top hung brackets</i>	Staffe di supporto <i>Support brackets</i>
				
			Dima per l'installazione <i>Mounting template</i>	Manuale d'uso <i>User manual</i>
				

Kit Smart Twin



Kit per l'installazione di 2 attuatori SMART 230VAC sullo stesso infisso



Article	Product code	Push / pull	Strokes	Colour	Power supply	Power	Weight	Pcs
SMART TWIN 230Vac	MKSMART20H0B01	200/250 N	180 - 380 mm	NERO / Black	230VAC	22W	2,50 kg	1
SMART TWIN 230Vac	MKSMART20H0G01	200/250 N	180 - 380 mm	GRIGIO / Grey	230VAC	22W	2,50 kg	1
SMART TWIN 230Vac	MKSMART20H0W01	200/250 N	180 - 380 mm	BIANCO / White	230VAC	22W	2,50 kg	1



STAR 25



Attuatore elettromeccanico modello STAR 25 con catena articolata a doppia maglia e spessore maggiorato. Disponibile nelle versioni 230VAC e 24VDC. Sistema di finecorsa elettronico in apertura e ad assorbimento di corrente in chiusura. Fino a 6 diverse corse facilmente regolabili mediante trimmer anche a motore non alimentato. Collegabile in parallelo. È possibile l'installazione di due STAR 25 230VAC nello stesso serramento mediante l'utilizzo della scheda AF 960.

Electromechanical actuator model STAR 25 with double link articulated chain and increased thickness. Available in 230VAC and 24VDC versions. Electronic limit switch system in opening and current absorption in closing. Up to 6 different strokes easily adjustable by trimmer even when the motor is not powered. Can be connected in parallel. It is possible to install two STAR 25 230VAC in the same window using the AF 960 board.





STAR 25



Attuatore a catena per apertura e chiusura di finestre in legno, PVC, alluminio e acciaio. Adatto ad aperture a vasistas, sporgere, shed, lucernai e cupolini.

Chain actuator for opening and closing wooden, PVC, aluminum and steel windows. Suitable for bottom-hung, protruding, shed, skylights and small domes.

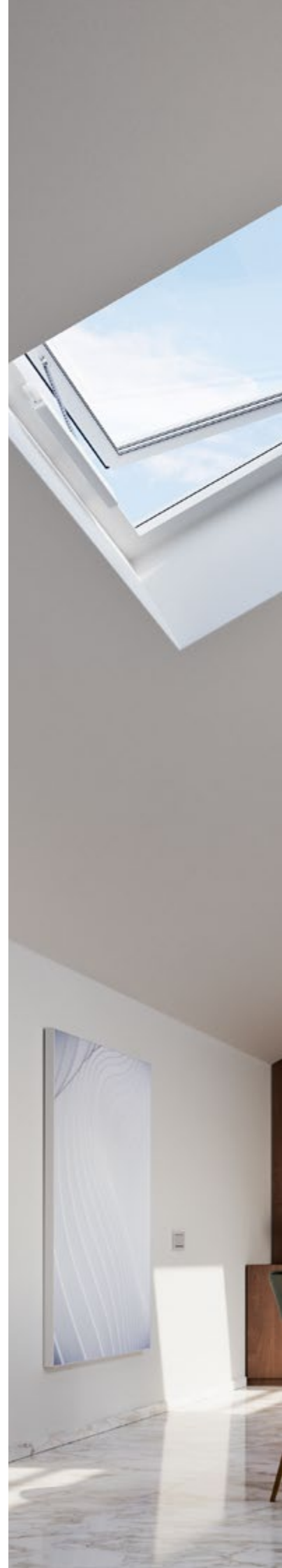



STAR 25



One Smart

24
VDC

Power

230
VAC

NV

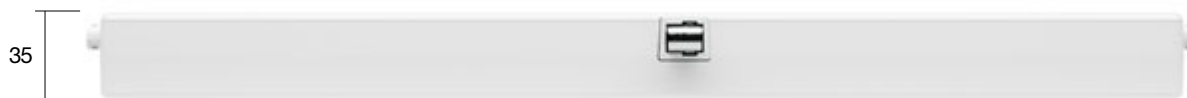

Trimmer

Posizioni 1-2-3-4-5-6: Impostazione corsa catena: 100-150-200-250-300-380 mm.

Trimmer

Posizioni 1-2-3-4-5-6: Chain stroke setting: 100-150-200-250-300-380 mm.



Vasistas

Bottom hung



Sporgere

Top hung



Caratteristiche principali

Main features

Compatto

Compact

Le dimensioni contenute consentono l'installazione anche in spazi ridotti.

The small size allows installation even in small spaces.

Sicuro

Safe

I rallentamenti nelle fasi di apertura e chiusura garantiscono sicurezza e precisione.

Slowdowns in the opening and closing phases ensure safety and accuracy.

Regolabile

Adjustable

6 lunghezze di corsa catena facilmente regolabili mediante trimmer anche ad attuatore non alimentato.

6 chain stroke lengths easily adjustable by trimmer even when the actuator is not powered.

Caratteristiche tecniche / Technical data sheet

	STAR 25 - 230 V	STAR 25 - 24 V
Forza Trazione / <i>Traction force</i>	250 N	250 N
Forza Spinta / <i>Thrust force</i>	250 N	250 N
Alimentazione / <i>Power supply</i>	230 VAC	24 VDC
Frequenza / <i>Frequency</i>	50/60 Hz	-
Tipo di servizio / <i>Type of service</i>	3 Min ON 7 Min OFF	3 Min ON 7 Min OFF
Velocità a vuoto / <i>Unloaded stroke speed</i>	17 mm/s	17 mm/s
Velocità evacuazione fumi / <i>Smoke evacuation speed</i>	No	No
Corse disponibili / <i>Strokes available</i>	100 - 150 - 200 - 250 - 300 - 380	100 - 150 - 200 - 250 - 300 - 380
Temperatura di funzionamento / <i>Operating temperature</i>	-5°C + 50°C	-5°C + 50°C
Grado di protezione IP / <i>IP protection class</i>	30	30
Soft START/Soft Stop	Sì / Yes	Sì / Yes
Assorbimento corrente / <i>Current draw</i>	0,19 A	1 A
Potenza assorbita / <i>Power draw</i>	28 W	28 W
Rilevamento ostacolo / <i>Obstacle detection</i>	Assorbimento di corrente <i>Current draw</i>	Assorbimento di corrente <i>Current draw</i>
Collegamento in parallelo / <i>Connection in parallel</i>	Max 30 Attuatori <i>Max 30 actuators</i>	Max 30 Attuatori <i>Max 30 actuators</i>
Sincronizzazione / <i>Synchronisation</i>	No	No
Dimensioni / <i>Dimensions</i>	34 X 48 X 433 mm	34 X 48 X 433 mm
Finecorsa in apertura / <i>Open limit switch</i>	Encoder	Encoder
Finecorsa in chiusura / <i>Closed limit switch</i>	Amperometrica / <i>Amperometric</i>	Amperometrica / <i>Amperometric</i>
Peso attuatore / <i>Actuator weight</i>	1,120 Kg	1,120 Kg

Resistente

Resistance

La catena robusta a doppia maglia e a spessore maggiorato garantisce una maggiore resistenza in spinta e in trazione.

The sturdy double-link chain with increased thickness guarantees greater resistance in push and pull.

Affidabile

Reliable

Le staffe di supporto consentono l'oscillazione dell'attuatore per accompagnare il movimento della finestra.

The support brackets allow the actuator to swing to accompany the movement of the window.

Finecorsa

Limit Switch

Apprendimento del finecorsa in chiusura automatico per assorbimento di corrente. In questo modo è garantita una chiusura sicura e costante nel tempo.

Acquisition of the automatic closing limit switch by current absorption. In this way, a safe and constant closure over time is guaranteed.

STAR 25

24
VDC230
VAC

One Smart

Power

NV

Configurazione dell'attuatore

Actuator configuration



Sporgere
Top hung

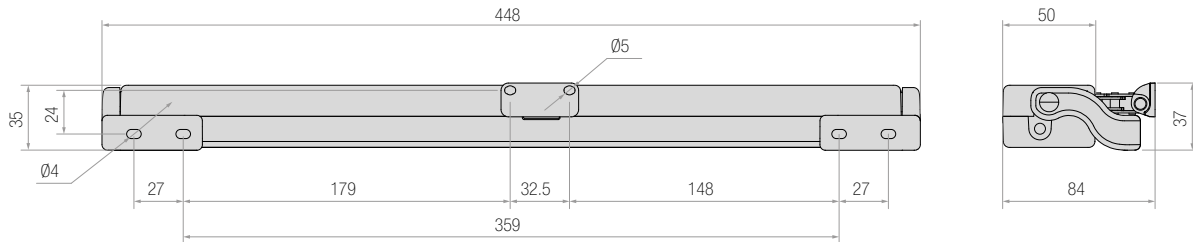

STAR 25 - Angolo di apertura anta a sporgere

STAR 25 - Top hung opening angle

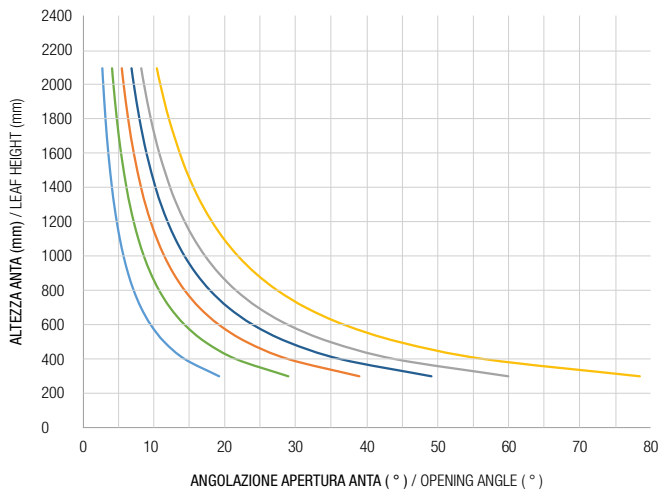

CORSA / STROKE — 100 mm — 150 mm — 200 mm — 250 mm — 300 mm — 380 mm

STAR 25 - Portate attuatori a sporgere

STAR 25 - Actuator force - top hung

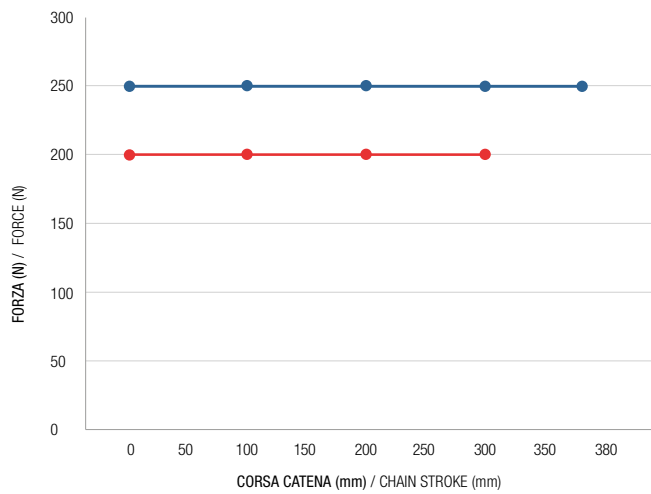

—●— SPORGERE / TOP HUNG OUTWARD OPENING —●— CUPOLA / DOME

I valori indicati nei grafici sono da considerarsi indicativi e non considerano eventuali deformazioni dovute a fattori esterni.
The values indicated in the graphs are to be considered indicative and do not consider any deformations due to external factors.

Per scegliere l'attuatore Comunello Mowin più adatto, è necessario calcolare la FORZA (F) necessaria a sostenere il movimento della finestra. Il tipo di attuatore va selezionato considerando la combinazione tra la dimensione di BASE del serramento e la forza calcolata (N).

In order to choose the most suitable Comunello Mowin actuator, you have to calculate the necessary FORCE (F) to sustain the window movement. Choose the actuator type in accordance with the CALCULATED FORCE (N) and the FRAME DIMENSION.



Vasistas
Bottom hung

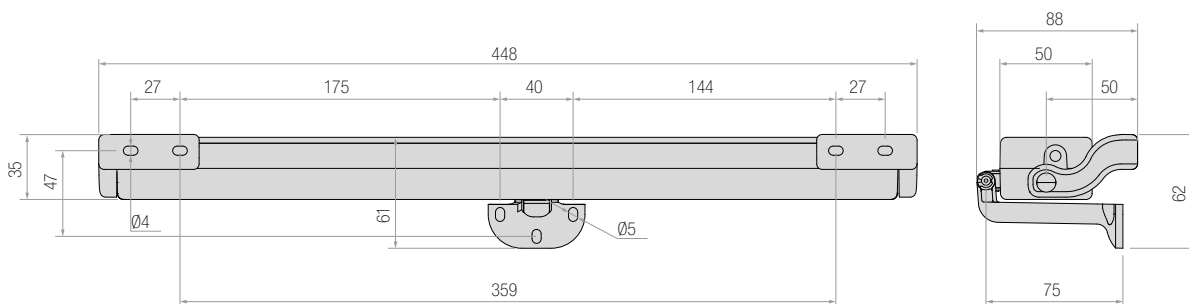

STAR 25 - Angolo di apertura anta vasistas
STAR 25 - Bottom hung opening angle

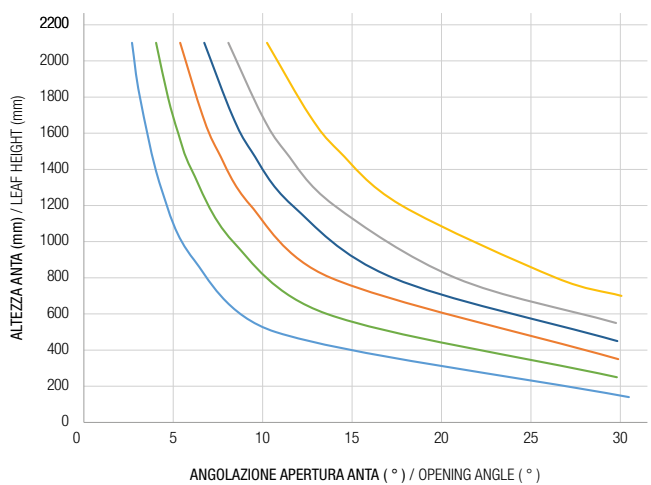

STAR 25 - Portate attuatori vasistas
STAR 25 - Actuator force - bottom hung

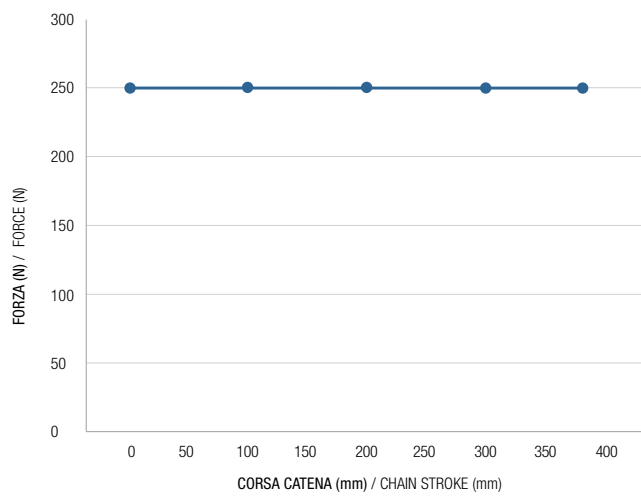

CORSA / STROKE — 100 mm — 150 mm — 200 mm — 250 mm — 300 mm — 380 mm

● VASISTAS / BOTTOM HUNG INWARD OPENING

I valori indicati nei grafici sono da considerarsi indicativi e non considerano eventuali deformazioni dovute a fattori esterni.
The values indicated in the graphs are to be considered indicative and do not consider any deformations due to external factors.

Formule per il calcolo della forza necessaria a movimentare il serramento *Formulas for calculating the force necessary to move the window*

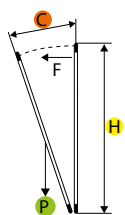

$$\frac{C \div H}{2} \times (P \div 2) = F \text{ Kg}$$

$$F \text{ (Kg)} \times 9,8 = \mathbf{N F \text{ (N)}}$$

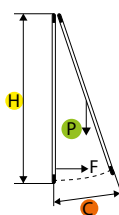

$$\frac{C \div H}{2} \times (P \div 2) = F \text{ Kg}$$

$$F \text{ (Kg)} \times 9,8 = \mathbf{N F \text{ (N)}}$$

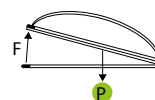

$$P \div 2 = F \text{ Kg}$$

$$F \text{ (Kg)} \times 9,8 = \mathbf{N F \text{ (N)}}$$













F = Forza necessaria
Necessary Force (Kg)

C = Corsa di apertura
Opening stroke (mm)

H = Altezza serramento
Window height (mm)

P = Peso serramento
Window weight (Kg)

STAR 25

Article	Commercial code	Product code	Push / pull	Strokes	Colour	Power supply	Weight	Pcs
STAR 25	STAR 25-24V	 MT25 S VN NW 38L 0B 00 Z	250 N	100 - 150 - 200 - 250 - 300 - 380 mm	NERO / Black 	24VDC	1,20 kg	1
STAR 25	STAR 25-24V	 MT25 S VN NW 38L 0G 00 Z	250 N	100 - 150 - 200 - 250 - 300 - 380 mm	GRIGIO / Grey 	24VDC	1,20 kg	1
STAR 25	STAR 25-24V	 MT25 S VN NW 38L 0W 00 Z	250 N	100 - 150 - 200 - 250 - 300 - 380 mm	BIANCO / White 	24VDC	1,20 kg	1
STAR 25	STAR 25-230V	 MT25 S VN NW 38H 0B 00 Z	250 N	100 - 150 - 200 - 250 - 300 - 380 mm	NERO / Black 	230VAC	1,20 kg	1
STAR 25	STAR 25-230V	 MT25 S VN NW 38H 0G 00 Z	250 N	100 - 150 - 200 - 250 - 300 - 380 mm	GRIGIO / Grey 	230VAC	1,20 kg	1
STAR 25	STAR 25-230V	 MT25 S VN NW 38H 0W 00 Z	250 N	100 - 150 - 200 - 250 - 300 - 380 mm	BIANCO / White 	230VAC	1,20 kg	1

La confezione contiene:		Box contains:									
	Attuatore <i>Actuator</i>		Staffe Vasistas <i>Vasistas brackets</i>		Staffe Sporgere <i>Top hung brackets</i>		Staffe di supporto <i>Support brackets</i>		Dima per l'installazione <i>Mounting template</i>		Manuale d'uso <i>User manual</i>



STAR 30



Attuatore elettromeccanico modello STAR 30 con catena articolata a doppia maglia e spessore maggiorato. Disponibile nelle versioni 230VAC e 24VDC. Sistema di finecorsa elettronico in apertura e ad assorbimento di corrente in chiusura. Fino a 4 diverse corse facilmente regolabili mediante trimmer anche a motore non alimentato. Collegabile in parallelo.

È possibile l'installazione di due STAR 30 230VAC nello stesso serramento mediante l'utilizzo della scheda AF 960.

Electromechanical actuator model STAR 30 with double link articulated chain and increased thickness. Available in 230VAC and 24VDC versions. Electronic limit switch system in opening and current absorption in closing. Up to 4 different strokes easily adjustable by trimmer even when the motor is not powered. Can be connected in parallel.

It is possible to install two STAR 30 230VAC in the same window using the AF 960 board.





STAR 30



Attuatore a catena per apertura e chiusura di finestre in legno, PVC, alluminio e acciaio. Adatto ad aperture a vasistas, sporgere, shed e lucernai.

Chain actuator for opening and closing wooden, PVC, aluminum and steel windows. Suitable for bottom-hung, protruding, shed and skylights.





STAR 30

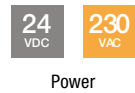

Trimmer

Posizioni 1-2-3-4: Impostazione corsa catena: 200-250-300-360 mm.

Trimmer

Posizioni 1-2-3-4: Chain stroke setting: 200-250-300-360 mm.



Vasistas
Bottom hung



Sporgere
Top hung



Caratteristiche principali

Main features

Compatto

Compact

Le dimensioni contenute consentono l'installazione anche in spazi ridotti.

The small size allows installation even in small spaces.

Sicuro

Safe

I rallentamenti nelle fasi di apertura e chiusura garantiscono sicurezza e precisione.

Slowdowns in the opening and closing phases ensure safety and accuracy.

Regolabile

Adjustable

6 lunghezze di corsa catena facilmente regolabili mediante trimmer anche ad attuatore non alimentato.

6 chain stroke lengths easily adjustable by trimmer even when the actuator is not powered.

Caratteristiche tecniche / Technical data sheet

	STAR 30 - 230 V	STAR 30 - 24 V
Forza trazione / <i>Traction force</i>	300 N	300 N
Forza spinta / <i>Thrust force</i>	300 N	300 N
Alimentazione / <i>Power supply</i>	230 VAC	24 VDC
Frequenza / <i>Frequency</i>	50 Hz	-
Tipo di servizio / <i>Type of service</i>	s2 4min	s2 4min
Velocità a vuoto / <i>Unloaded stroke speed</i>	18 mm/s	18 mm/s
Velocità evacuazione fumi / <i>Smoke evacuation speed</i>	No	No
Corse disponibili / <i>Strokes available</i>	200 - 250 - 300 - 360 mm	200 - 250 - 300 - 360 mm
Temperatura di funzionamento / <i>Operating temperature</i>	-5°C + 50°C	-5°C + 50°C
Grado di protezione IP / <i>IP protection class</i>	30	30
Soft START / Soft STOP	Sì / Yes	Sì / Yes
Assorbimento corrente / <i>Current draw</i>	0,19 A	1 A
Potenza assorbita / <i>Power draw</i>	28 W	28 W
Rilevamento ostacolo / <i>Obstacle detection</i>	Sì / Yes	Sì / Yes
Collegamento in parallelo / <i>Connection in parallel</i>	Sì (max 30 attuatori) Yes (max 30 actuators)	Sì (max 30 attuatori) Yes (max 30 actuators)
Sincronizzazione / <i>Synchronisation</i>	No	No
Dimensioni / <i>Dimensions</i>	34 x 57 x 390 mm	34 x 57 x 390 mm
Finecorsa in apertura / <i>Open limit switch</i>	Encoder	Encoder
Finecorsa in chiusura / <i>Closed limit switch</i>	Amperometrica / <i>Amperometric</i>	Amperometrica / <i>Amperometric</i>
Peso attuatore / <i>Actuator weight</i>	1,18 kg	1,18 kg

Resistente

Resistance

La catena robusta a doppia maglia e a spessore maggiorato garantisce una maggiore resistenza in spinta e in trazione.

The sturdy double-link chain with increased thickness guarantees greater resistance in push and pull.

Affidabile

Reliable

Le staffe di supporto consentono l'oscillazione dell'attuatore per accompagnare il movimento della finestra.

The support brackets allow the actuator to swing to accompany the movement of the window.

Finecorsa

Limit switch

Apprendimento del finecorsa in chiusura automatico per assorbimento di corrente. In questo modo è garantita una chiusura sicura e costante nel tempo.

Acquisition of the automatic closing limit switch by current absorption. In this way, a safe and constant closure over time is guaranteed.

STAR 30

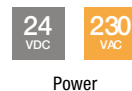

Configurazione dell'attuatore

Actuator configuration



Sporgere
Top hung

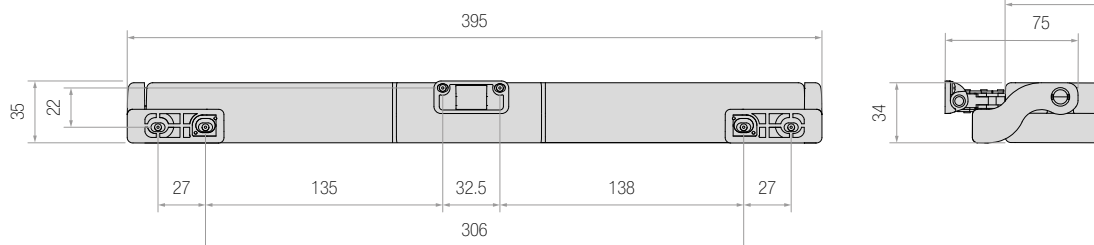

STAR 30 - Angolo di apertura anta a sporgere

STAR 30 - Top hung opening angle

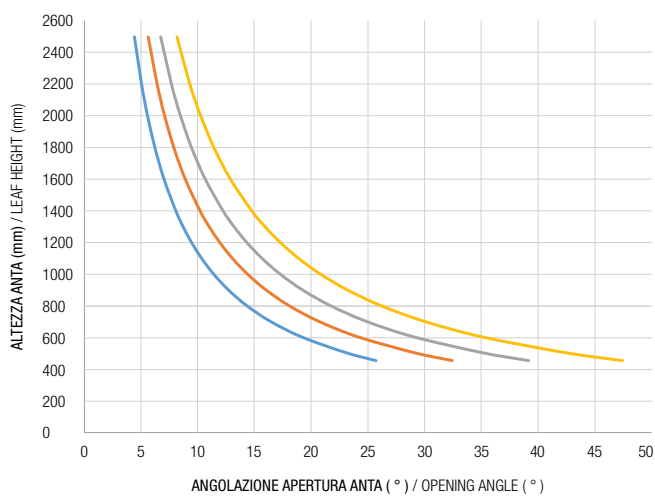

CORSA / STROKE — 200 mm — 250 mm — 300 mm — 360 mm

STAR 30 - Portate attuatori a sporgere

STAR 30 - Actuator force - top hung

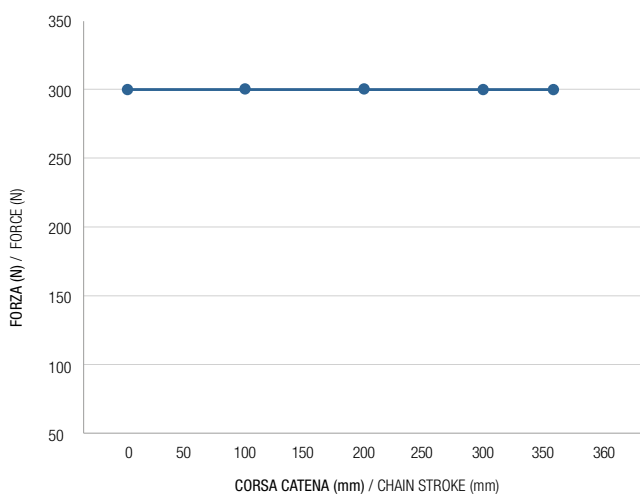

—●— SPORGERE / TOP HUNG OUTWARD OPENING

I valori indicati nei grafici sono da considerarsi indicativi e non considerano eventuali deformazioni dovute a fattori esterni.
The values indicated in the graphs are to be considered indicative and do not consider any deformations due to external factors.

Per scegliere l'attuatore Comunello Mowin più adatto, è necessario calcolare la FORZA (F) necessaria a sostenere il movimento della finestra. Il tipo di attuatore va selezionato considerando la combinazione tra la dimensione di BASE del serramento e la forza calcolata (N).

In order to choose the most suitable Comunello Mowin actuator, you have to calculate the necessary FORCE (F) to sustain the window movement. Choose the actuator type in accordance with the CALCULATED FORCE (N) and the FRAME DIMENSION.



Vasistas
Bottom hung

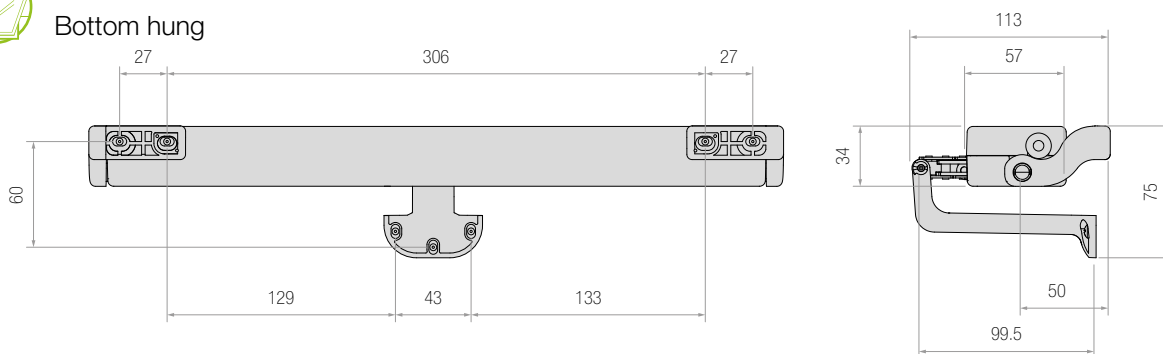

STAR 30 - Angolo di apertura anta vasistas
STAR 30 - Bottom hung opening angle

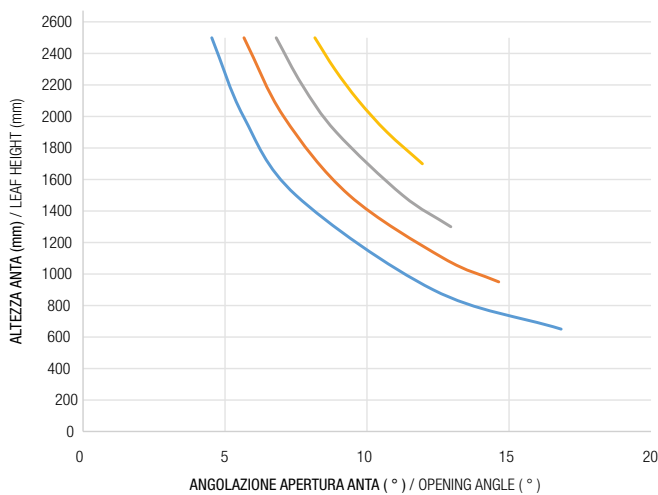

CORSA / STROKE — 200 mm — 250 mm — 300 mm — 360 mm

STAR 30 - Portate attuatori vasistas
STAR 30 - Actuator force - bottom hung

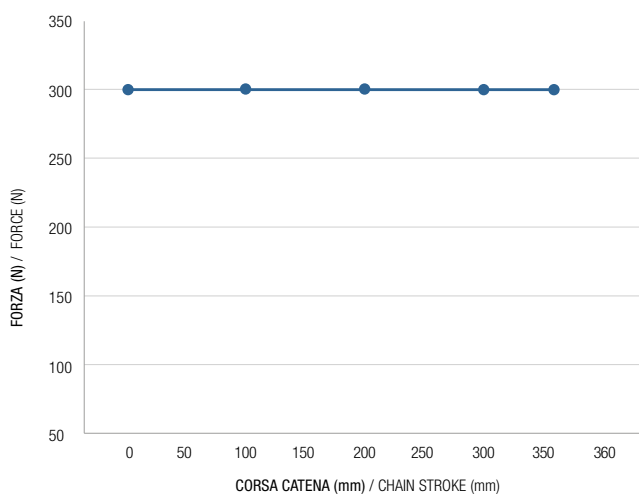

—●— VASISTAS / BOTTOM HUNG INWARD OPENING

I valori indicati nei grafici sono da considerarsi indicativi e non considerano eventuali deformazioni dovute a fattori esterni.
The values indicated in the graphs are to be considered indicative and do not consider any deformations due to external factors.

Formule per il calcolo della forza necessaria a movimentare il serramento *Formulas for calculating the force necessary to move the window*

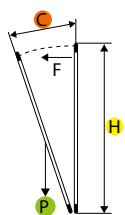

$$\frac{C \div H}{F} \times (P \div 2) = F \text{ Kg}$$

$$F \text{ (Kg)} \times 9,8 = \mathbf{N F \text{ (N)}}$$

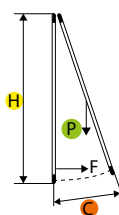

$$\frac{C \div H}{F} \times (P \div 2) = F \text{ Kg}$$

$$F \text{ (Kg)} \times 9,8 = \mathbf{N F \text{ (N)}}$$

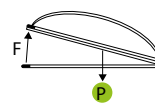

$$P \div 2 = F \text{ Kg}$$

$$F \text{ (Kg)} \times 9,8 = \mathbf{N F \text{ (N)}}$$

F = Forza necessaria
Necessary Force (Kg)

C = Corsa di apertura
Opening stroke (mm)

H = Altezza serramento
Window height (mm)

P = Peso serramento
Window weight (Kg)

STAR 30

Article	Commercial code	Product code	Push / pull	Strokes	Colour	Power supply	Weight	Pcs
STAR 30	STAR 30-24V	MT30 S VN NW 36L 0B 00 Z	300 N	200 – 250 – 300- 360	NERO / Black	24 VDC	1,18 kg	1
STAR 30	STAR 30-24V	MT30 S VN NW 36L 0G 00 Z	300 N	200 – 250 – 300- 360	GRIGIO / Grey	24 VDC	1,18 kg	1
STAR 30	STAR 30-24V	MT30 S VN NW 36L 0W 00 Z	300 N	200 – 250 – 300- 360	BIANCO / White	24 VDC	1,18 kg	1
STAR 30	STAR 30-230V	MT30 S VN NW 36H 0B 00 Z	300 N	200 – 250 – 300- 360	NERO / Black	230 VAC	1,18 kg	1
STAR 30	STAR 30-230V	MT30 S VN NW 36H 0G 00 Z	300 N	200 – 250 – 300- 360	GRIGIO / Grey	230 VAC	1,18 kg	1
STAR 30	STAR 30-230V	MT30 S VN NW 36H 0W 00 Z	300 N	200 – 250 – 300- 360	BIANCO / White	230 VAC	1,18 kg	1

La confezione contiene: <i>Box contains:</i>						
	Attuatore <i>Actuator</i>	Staffe Vasistas <i>Vasistas brackets</i>	Staffe Sporgere <i>Top hung brackets</i>	Staffe di supporto <i>Support brackets</i>	Dima per l'installazione <i>Mounting template</i>	Manuale d'uso <i>User manual</i>
						



FAST



Attuatore a stelo per apertura e chiusura di finestre in legno, PVC, alluminio e acciaio. Adatto ad aperture a sporgere, lucernai, shed, cupole e pale frangisole.

Dotato di finecorsa elettromeccanico sia in apertura che in chiusura. Disponibile in 4 versioni 230Vac con corse 160-200-300-400mm.

Rod actuator for opening and closing wooden, PVC, aluminum and steel windows. Suitable for projecting openings, skylights, shed, domes and sunshade blades.

Equipped with electromechanical limit switch in both opening and closing. Available in 4 230Vac versions with 160-200-300-400mm strokes.





FAST



Attuatore a stelo per apertura e chiusura di finestre in legno, PVC, alluminio e acciaio. Adatto ad aperture a sporgere, lucernai, shed, cupole e pale frangisole.

Rod actuator for opening and closing wooden, PVC, aluminum and steel windows. Suitable for projecting openings, skylights, shed, domes and sunshade blades.

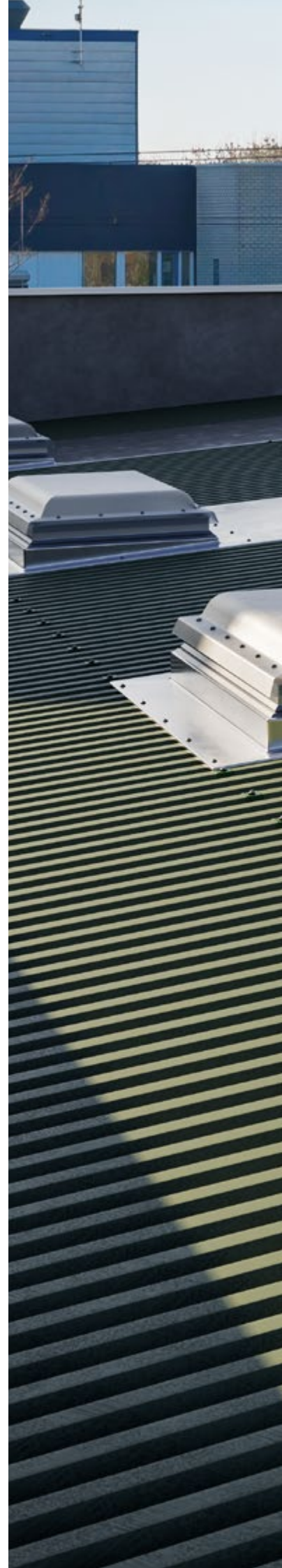

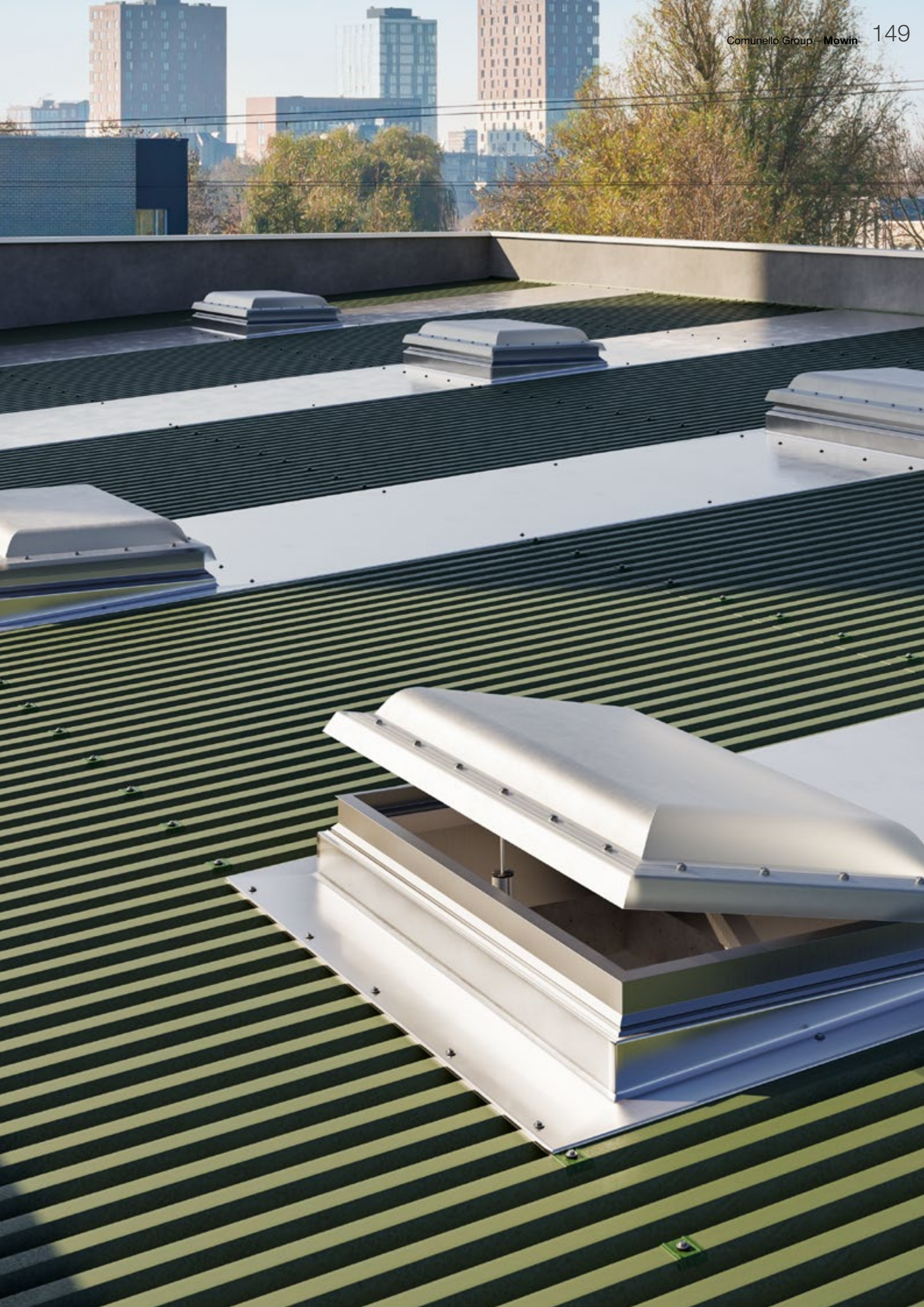

FAST 50

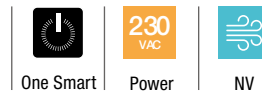

Caratteristiche principali

Main features

Installazione

Installation

Fissaggio della staffa regolabile lungo il binario del corpo dell'attuatore.

Fixing of the adjustable bracket along the rail of the actuator body.

Grado di protezione IP55

Degree of protection IP55

Il grado di protezione IP 55 rende l'attuatore adatto ad ambienti particolarmente difficili.

The IP 55 degree of protection makes the actuator suitable for particularly difficult environments.

Completo

Complete

L'attuatore Fast viene fornito con le staffe di supporto attuatore e di fissaggio anta comprese.

The Fast actuator is supplied with the actuator support and leaf fixing brackets included.

Caratteristiche tecniche / Technical data sheet

	FAST 50/160	FAST 50/200	FAST 50/300	FAST 50/400
Alimentazione <i>Power supply</i>	230 Vac	230 Vac	230 Vac	230 Vac
Frequenza / <i>Frequency</i>	50 Hz	50 Hz	50 Hz	50 Hz
Tipo di servizio / <i>Type of service</i>	s2 4 min.	S2 4 min.	S2 4 min.	S2 4 min.
Forza di spinta/trazione <i>Thrust / traction force</i>	500 N	500 N	500 N	500 N
Velocità di traslazione a vuoto <i>Unloaded stroke speed</i>	~ 20 mm/s	~ 20 mm/s	~ 20 mm/s	~ 20 mm/s
Grado di protezione IP <i>IP protection class</i>	IP 55	IP 55	IP 55	IP 55
Potenza / <i>Power</i>	160 W	160 W	160 W	160 W
Assorbimento / <i>Rated Current</i>	0.7 A	0.7 A	0.7 A	0.7 A
Temperatura di funzionamento <i>Operating temperature</i>	-5° / +50° °C	-5° / +50° °C	-5° / +50° °C	-5° / +50° °C
Corsa mm / <i>Stroke mm</i>	160 mm	200 mm	300 mm	400 mm
Finecorsa in apertura <i>Open limit switch</i>	Switch	Switch	Switch	Switch
Finecorsa in chiusura <i>Closed limit switch</i>	seniore reed	seniore reed	seniore reed	seniore reed
Collegamento in parallelo <i>Connection in parallel</i>	Sì / Yes Max 30 attuatori <i>Max 30 actuators</i>	Sì / Yes Max 30 attuatori <i>Max 30 actuators</i>	Sì / Yes Max 30 attuatori <i>Max 30 actuators</i>	Sì / Yes Max 30 attuatori <i>Max 30 actuators</i>
Dimensioni (L) / <i>Dimensions (L)</i>	299,5 x 76 x 68 mm	299,5 x 76 x 68 mm	399,5 x 76 x 68 mm	499,5 x 76 x 68 mm

Forza

Force

La forza elevata di 500N sia in trazione che in spinta rende l'attuatore adatto anche a serramenti particolarmente pesanti.

The high force of 500N both in traction and in thrust makes the actuator also suitable for particularly heavy frames.

Corsa

Stroke

Sono disponibili 4 versioni di FAST 50 rispettivamente con corse 160-200-300-400mm.

There are 4 versions of FAST 50 respectively with 160-200-300-400mm strokes.

Applicazione

Application

Le caratteristiche tecniche di FAST 50 rendono l'attuatore adatto alle applicazioni a sporgere, cupole lucernai e pale frangisole.

The technical characteristics of FAST 50 make the actuator suitable for projecting applications, skylight domes and sunscreen blades.

FAST 50

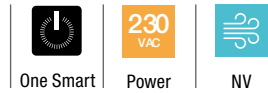

Configurazione dell'attuatore

Actuator configuration

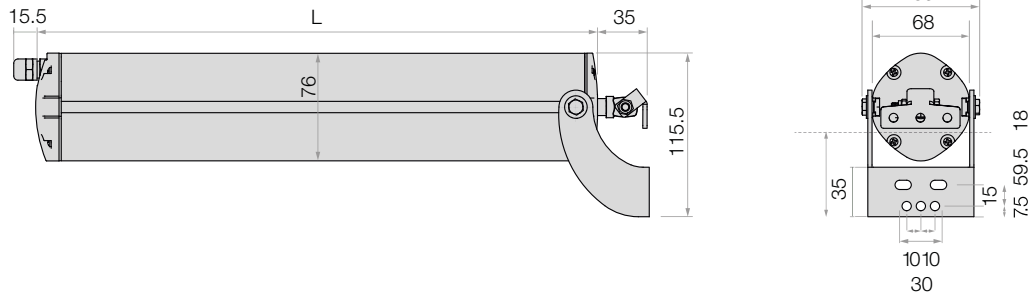

FAST - Angolo di apertura anta a sporgere

FAST - Top hung opening angle

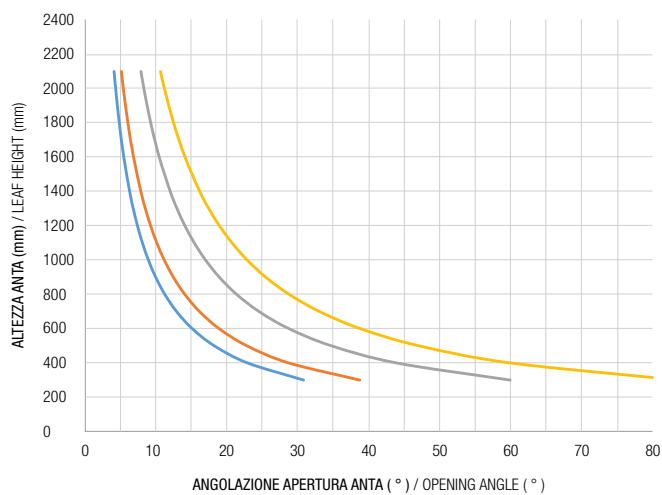

CORSA / STROKE — 160 mm — 200 mm — 300 mm — 400 mm

I valori indicati nei grafici sono da considerarsi indicativi e non considerano eventuali deformazioni dovute a fattori esterni.
The values indicated in the graphs are to be considered indicative and do not consider any deformations due to external factors.

Per scegliere l'attuatore Comunello Mowin più adatto, è necessario calcolare la FORZA (F) necessaria a sostenere il movimento della finestra. Il tipo di attuatore va selezionato considerando la combinazione tra la dimensione di BASE del serramento e la forza calcolata (N).

Formule per il calcolo della forza necessaria a movimentare il serramento

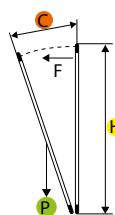

$$\frac{(C \div H) \times (P \div 2) = F \text{ Kg}}{F \text{ (Kg)} \times 9,8 = \mathbf{N F \text{ (N)}}$$

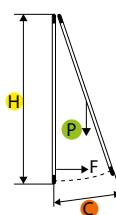

$$\frac{(C \div H) \times (P \div 2) = F \text{ Kg}}{F \text{ (Kg)} \times 9,8 = \mathbf{N F \text{ (N)}}$$

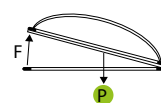

$$\frac{P \div 2 = F \text{ Kg}}{F \text{ (Kg)} \times 9,8 = \mathbf{N F \text{ (N)}}$$

F = Forza necessaria
Necessary Force (Kg)

C = Corsa di apertura
Opening stroke (mm)

H = Altezza serramento
Window height (mm)

P = Peso serramento
Window weight (Kg)

FAST - Portate attuatori a sporgere e cupola

FAST - Actuator force - top hung and dome

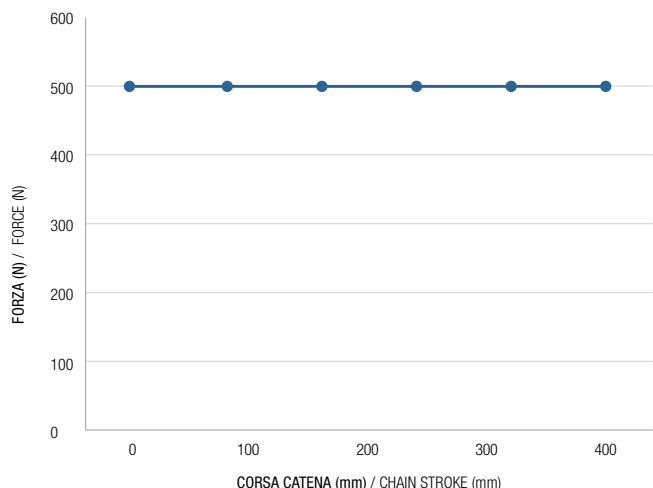













— SPORGERE / TOP HUNG OUTWARD OPENING CUPOLA / DOME

In order to choose the most suitable Comunello Mowin actuator, you have to calculate the necessary FORCE (F) to sustain the window movement. Choose the actuator type in accordance with the CALCULATED FORCE (N) and the FRAME DIMENSION.

Formulas for calculating the force necessary to move the window



Article	Product code	Push / pull	Strokes	Lenght L	Colour	Power	Motor voltage	Weight	Pcs
50/160 230V basic	 MFAST 160 H 0B 00	500 N	160 mm	299,5 mm	Grey RAL 7035 	170W	0,7A	1,90 Kg	1
50/200 230V basic	 MFAST 200 H 0B 00	500 N	200 mm	299,5 mm	Grey RAL 7035 	170W	0,7A	2,00 Kg	1
50/300 230V basic	 MFAST 300 H 0B 00	500 N	300 mm	399,5 mm	Grey RAL 7035 	170W	0,7A	2,20 Kg	1
50/400 230V basic	 MFAST 400 H 0B 00	500 N	400 mm	499,5 mm	Grey RAL 7035 	170W	0,7A	2,40 Kg	1

	La confezione contiene:	Box contains:		
	Attuatore <i>Actuator</i> 	Staffe di supporto <i>Support brackets</i> 	Attacco per finestre <i>Fitting for windows</i> 	Manuale d'uso <i>User manual</i> 



LIWIN L20 Insert Wi-Fi



Attuatore elettromeccanico in alluminio pressofuso modello LIWIN L20 Insert con guscio in metallo e catena a doppia maglia per aperture e chiusure di finestre vasistas. Le dimensioni ridotte rendono l'attuatore particolarmente adatto ad installazioni sia a scomparsa all'interno del profilo finestra, sia esternamente su spazi molto limitati. La nuova tecnologia Wi-Fi, oltre a dare la possibilità di regolare parametri come velocità e corsa della catena consente la sincronizzazione fino a 8 attuatori da poter installare in un'unica finestra di grandi dimensioni con piccoli ingombri. La nuova app Comunello Mowin consente inoltre di fare una diagnostica real time degli attuatori molto utile per risalire alle cause di eventuali anomalie.

Electromechanical actuator in die-cast aluminium model LIWIN L20 Insert with metal shell and double link chain for opening and closing of bottom-hung windows. The reduced dimensions make the actuator particularly suitable for installations both concealed inside the window profile and externally in very limited spaces. The new Wi-Fi technology, in addition to making it possible to adjust parameters such as speed and stroke of the chain, allows synchronization of up to 8 actuators that can be installed in a single large window with small dimensions. The new Comunello Mowin app also allows real-time diagnostics of the actuators, which is very useful for tracing the causes of any anomalies.

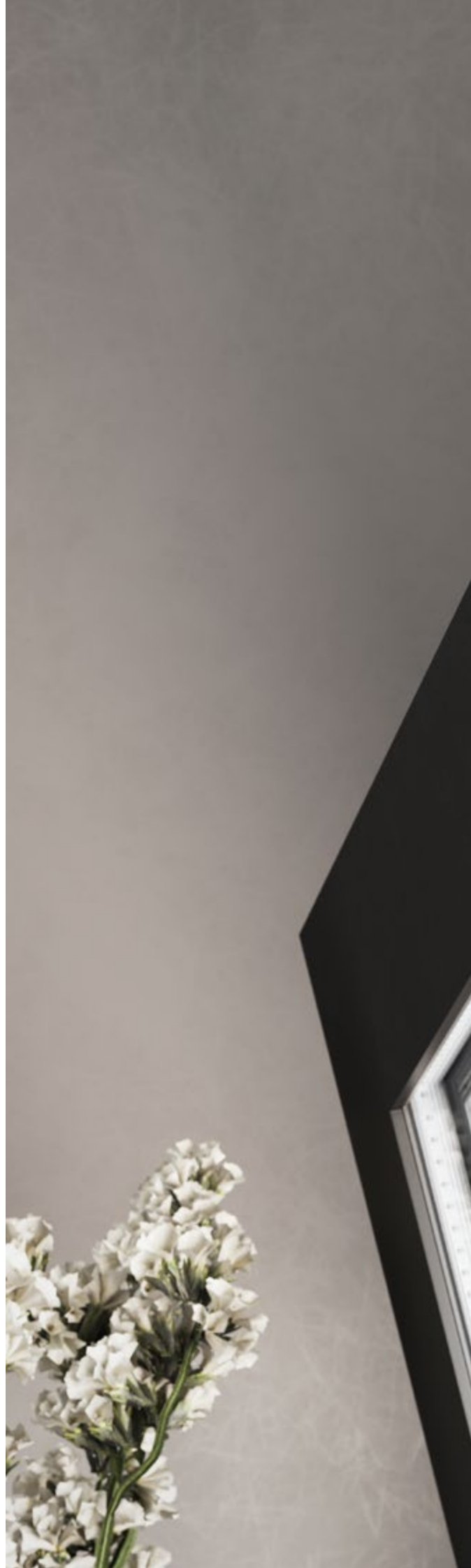



LIWIN L20 Insert Wi-Fi



Attuatore a catena con guscio in metallo per apertura e chiusura di finestre in legno, PVC, alluminio e acciaio. Adatto ad aperture a sporgere e vasistas con attuatore esterno o a scomparsa all'interno del profilo.

Chain actuator with metal shell for opening and closing wooden, PVC, aluminum and steel windows. Suitable for top-hung and bottom-hung openings with external actuator or concealed inside the profile.





LIWIN L20 Insert Wi-Fi

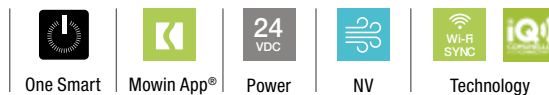

Trimmer

Posizione M: Stato attuatore SLAVE
Posizioni 1-2-3-4: Impostazione corsa catena: 100-150-200-250mm. La corsa dell'attuatore può essere regolata millimetricamente fino a 250mm mediante Mowin App.
Posizione A: Wi-Fi attivo - MASTER.

Trimmer

Position M: Slave actuator status
Positions 1-2-3-4-5-6: Chain stroke setting: 100-150-200-250 mm. The stroke of the actuator can be adjusted in millimeters up to 250 mm using the Mowin App.
Position A: Wi-Fi active - MASTER.



Vasistas
Bottom hung



Vasistas ad incasso
Recessed bottom hung



Caratteristiche principali

Main features

Corse Strokes

L'attuatore LIWIN L20 Insert Wi-Fi consente una regolazione manuale della corsa mediante trimmer e una regolazione millimetrica con la Mowin App.

The LIWIN L20 Insert Wi-Fi actuator allows one manual adjustment of the stroke by trimmer and a millimeter adjustment with the Mowin App.

Installazione a scomparsa Concealed installation

Le dimensioni della sezione 23 mm x 29 mm rendono l'attuatore particolarmente adatto ad installazioni a scomparsa all'interno del profilo.

The dimensions of the 23 mm x 29 mm section make the actuator particularly suitable for concealed installations inside the profile.

Installazione su spazi ridotti Installation in small spaces

Grazie alle staffe dedicate l'attuatore L20 Insert è anche particolarmente indicato per apertura a vasistas con fissaggio esterno e spazi ridotti.

Thanks to the dedicated brackets, the L20 Insert actuator is also particularly suitable for bottom-hung openings with external fixing and reduced spaces.

Caratteristiche tecniche / Technical data sheet

LIWIN L20 Insert Wi-Fi		
Forza trazione / Traction force	200 N*	
Forza spinta / Thrust force	200 N*	
Alimentazione / Power supply	24 vdc	
Velocità a vuoto / No-load speed	21 mm/s	
Tipo di servizio / Type of service	3 min On 7 min Off	
Corse disponibili / Strokes available	100 - 150 - 200 - 250	
Temperatura di funzionamento / Operating temperature	-5°C + 50°C	
Grado di protezione ip / Ip protection class	30	
Soft START / Soft STOP	Sì / Yes	
Rilevamento ostacolo / Obstacle detection	Assorbimento di corrente / Current draw	
Collegamento in parallelo / Connection in parallel	Sì / Yes	
Sincronizzazione / Synchronisation	Sì Fino a 8 attuatori / Yes Up to 8 actuators	
Dimensioni / Dimensions	24 x 29 x 422 mm	
Finecorsa in apertura / Open limit switch	encoder	
Finecorsa in chiusura / Closed limit switch	Amperometrica / Amperometric	
Corse disponibili / Strokes available	Regolazione millimetrica con app Mowin <i>Millimetric adjustment with Mowin app</i>	Regolazione millimetrica con app Mowin <i>Millimetric adjustment with Mowin app</i>

* Vedi grafici portate pag. 160-161 / See actuators graph pag. 160-161

Catena Chain

La qualità elevata e la robustezza della catena inox a doppia maglia garantiscono la trasmissione della forza massima sia in trazione che in spinta.

The high quality and sturdiness of the double link stainless steel chain guarantee the transmission of the maximum force both in traction and in thrust.

IQ Interconnectivity IQ Interconnectivity

L'interconnettività IQ è un innovativo sistema di comunicazione wireless. Grazie al dispositivo Wi-Fi posto all'interno del motore è possibile connettersi con l'app MOWIN per una completa configurazione degli attuatori e garantisce una perfetta sincronizzazione tra più attuatori installati sulla stessa finestra.

IQ interconnectivity is an innovative wireless communication system. Thanks to the Wi-Fi device placed inside the motor, it allows you to connect with the MOWIN app for complete configuration of the actuators and guarantee perfect synchronization between multiple actuators installed on the same window.

Diagnostica Diagnostics

La Mowin App consente sia la registrazione delle ultime manovre con le eventuali anomalie segnalate, sia di effettuare una diagnostica in tempo reale per individuare eventuali errori di malfunzionamento.

L'attuatore è anche dotato di un led in grado di segnalare se ci sono eventuali anomalie.

The Mowin App allows both the recording of the last manoeuvres with any reported anomalies and real-time diagnostics to identify any malfunction errors. The actuator is also equipped with a led able to signal if there are any anomalies.

LIWIN L20 Insert Wi-Fi

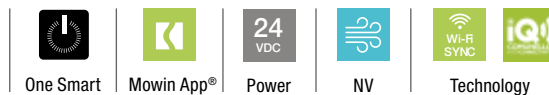

Configurazione dell'attuatore

Actuator configuration

Sporgere Top hung

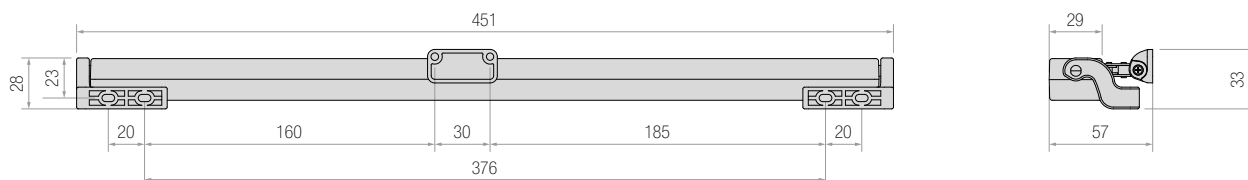

L20 Insert - Angolo di apertura anta a sporgere

L20 Insert - Top hung opening angle

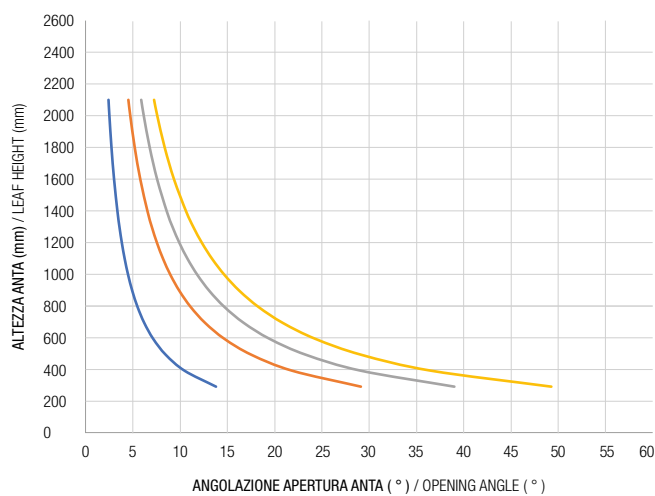

CORSA / STROKE — 100 mm — 150 mm — 200 mm — 250 mm

I valori indicati nei grafici sono da considerarsi indicativi e non considerano eventuali deformazioni dovute a fattori esterni.
The values indicated in the graphs are to be considered indicative and do not consider any deformations due to external factors.

Per scegliere l'attuatore Comunello Mowin più adatto, è necessario calcolare la FORZA (F) necessaria a sostenere il movimento della finestra. Il tipo di attuatore va selezionato considerando la combinazione tra la dimensione di BASE del serramento e la forza calcolata (N).

Per ante con BASE superiore a 1.5 metri, se il serramento è sufficientemente rigido, consigliamo l'installazione di sistemi sincronizzati come illustrato nel paragrafo Sincronizzazione di p.28.

L20 Insert - Portate attuatori a sporgere

L20 Insert - Actuator force - top hung

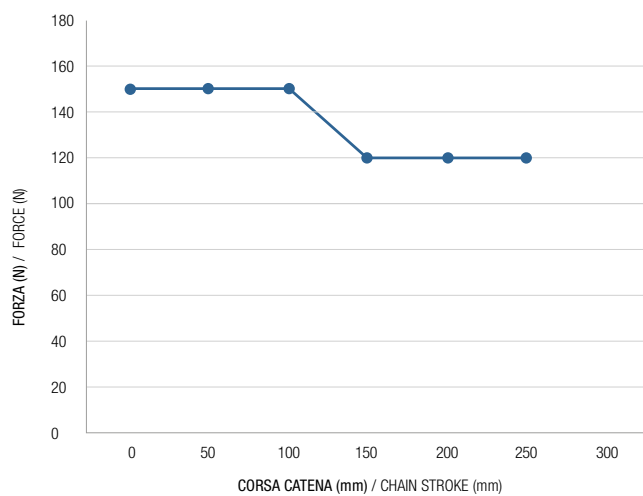

— VASISTAS / BOTTOM HUNG INWARD OPENING

In order to choose the most suitable Comunello Mowin actuator, you have to calculate the necessary FORCE (F) to sustain the window movement. Choose the actuator type in accordance with the CALCULATED FORCE (N) and the FRAME DIMENSION.

For leaves with a BASE greater than 1.5 metres, if the window is sufficiently rigid, we recommend the installation of synchronized systems as illustrated in the Synchronization paragraph on p.28.



Vasistas
Bottom hung

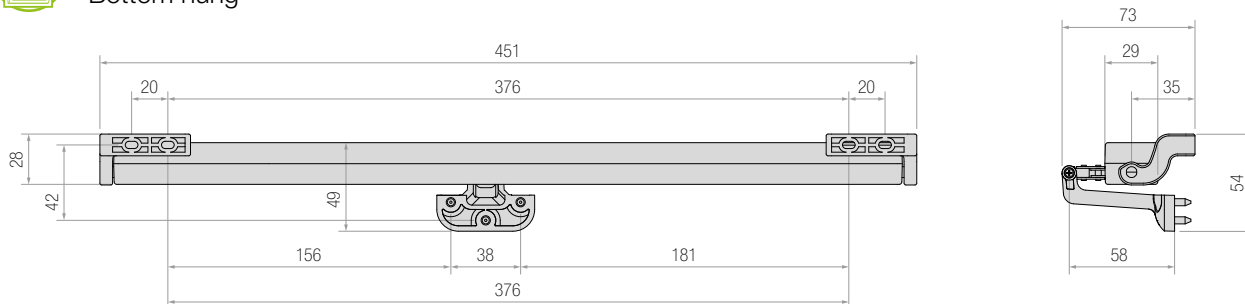

L20 Insert - Angolo di apertura anta vasistas
L20 Insert - Bottom hung opening angle

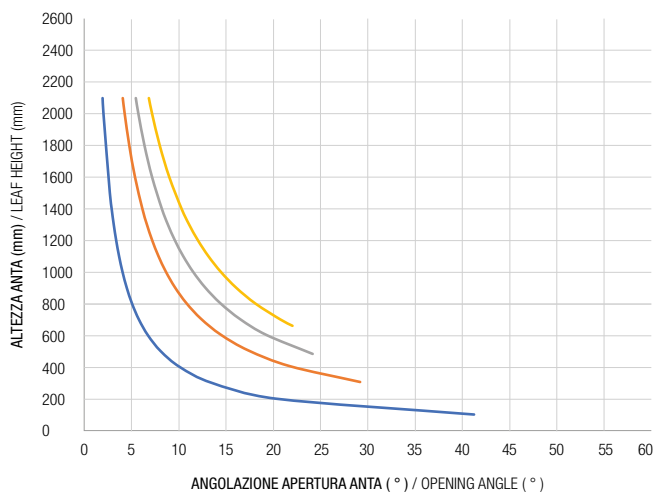

CORSA / STROKE — 70 mm — 150mm — 200 mm — 250 mm

L20 Insert - Portate attuatori vasistas
L20 Insert - Actuator force - bottom hung

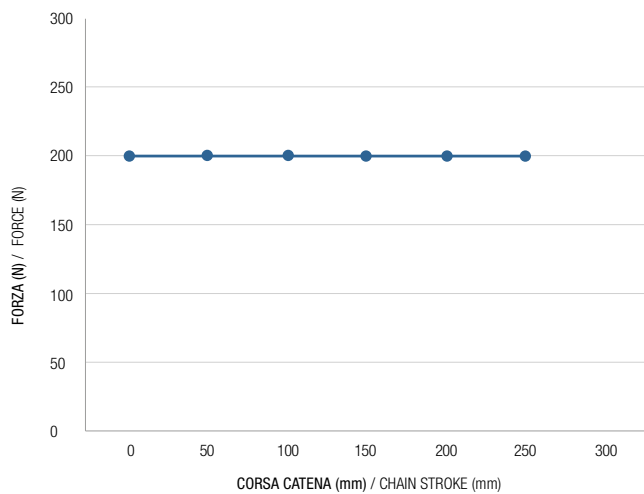

● SPORGERE / TOP HUNG OUTWARD OPENING

I valori indicati nei grafici sono da considerarsi indicativi e non considerano eventuali deformazioni dovute a fattori esterni.
The values indicated in the graphs are to be considered indicative and do not consider any deformations due to external factors.

Formule per il calcolo della forza necessaria a movimentare il serramento Formulas for calculating the force necessary to move the window

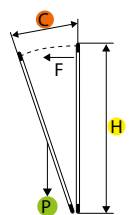

$$\frac{C \div H}{F} \times (P \div 2) = F \text{ Kg}$$

$$F \text{ (Kg)} \times 9,8 = \mathbf{N F \text{ (N)}}$$

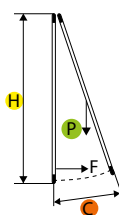

$$\frac{C \div H}{F} \times (P \div 2) = F \text{ Kg}$$

$$F \text{ (Kg)} \times 9,8 = \mathbf{N F \text{ (N)}}$$

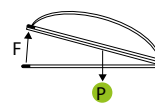

$$P \div 2 = F \text{ Kg}$$

$$F \text{ (Kg)} \times 9,8 = \mathbf{N F \text{ (N)}}$$







F = Forza necessaria
Necessary Force (Kg)

C = Corsa di apertura
Opening stroke (mm)





H = Altezza serramento
Window height (mm)

P = Peso serramento
Window weight (Kg)

LIWIN L20 Insert Wi-Fi

Article	Commercial code	Product code	Push / pull	Strokes	Colour	Power supply	Pcs
LIWIN L20 INS Wi-Fi	L20 24V INS-WF 	ML2I S VN WF 25L 0B 00 I	200 N	100-150-200-250 mm	NERO / Black 	24VDC	1
LIWIN L20 INS Wi-Fi	L20 24V INS-WF 	ML2I S VN WF 25L 0G 00 I	200 N	100-150-200-250 mm	GRIGIO / Grey 	24VDC	1
LIWIN L20 INS Wi-Fi	L20 24V INS-WF 	ML2I S VN WF 25L 0W 00 I	200 N	100-150-200-250 mm	BIANCO / White 	24VDC	1

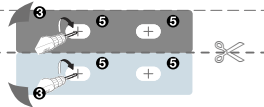
La confezione contiene - Box contains:

	<p>Attuatore <i>Actuator</i></p> 	<p>Dima per l'installazione <i>Mounting template</i></p> 	<p>Manuale d'uso <i>User manual</i></p> 
---	--	---	---



LIWIN L35 Slim

LIWIN L35 Slim Wi-Fi



Attuatore elettromeccanico modello LIWIN L35 con catena a doppia maglia e spessore maggiorato. Grazie alle dimensioni complessivamente ridotte ed in particolare lo spessore di soli 27 mm LIWIN 35/LIWIN 35 Wi-Fi è particolarmente adatto ad installazioni su spazi ristretti

La nuova tecnologia Wi-Fi, oltre a dare la possibilità di regolare parametri come velocità e corsa della catena consente la sincronizzazione fino a 8 attuatori da poter installare in un'unica finestra di grandi dimensioni o su sistemi in cui è necessaria una forza elevata. La nuova Mowin App consente inoltre di fare una diagnostica real time degli attuatori molto utile per risalire alle cause di eventuali anomalie.

Electromechanical actuator model LIWIN L35 with an increased thickness, double link chain. Thanks to the overall reduced dimensions and in particular the thickness of only 27 mm LIWIN 35/LIWIN 35 Wi-Fi is particularly suitable for installations in confined spaces

The new Wi-Fi technology, in addition to giving the possibility to adjust parameters such as speed and stroke of the chain, allows synchronization of up to 8 actuators that can be installed in a single large window or on systems where a high force is required. The new Mowin App also allows real-time diagnostics of the actuators, which is very useful for tracing the causes of any anomalies.





LIWIN L35 Slim

LIWIN L35 Slim Wi-Fi



Attuatore a catena per apertura e chiusura di finestre in legno, PVC, alluminio e acciaio. Adatto ad aperture a vasistas, sporgere, battente, apertura parallela, shed, lucernai e cupolini.

Chain actuator for opening and closing wooden, PVC, aluminum and steel windows. Suitable for bottom-hung, projecting, swing, parallel openings, sheds, skylights and small domes.





LIWIN L35 Slim

LIWIN L35 Slim Wi-Fi



One Smart



Mowin App®

24
VDC230
VAC110
VAC

NV



Technology



Agile



Trimmer

Posizione M: Stato attuatore SLAVE
Posizioni 1-2-3-4: Impostazione corsa catena: 120-300-350-400 mm. La corsa dell'attuatore può essere regolata millimetricamente fino a 400 mm mediante Mowin App.
Posizione A: Wi-Fi attivo - MASTER.

Trimmer

Position M: Slave actuator status
Positions 1-2-3-4: Chain stroke setting: 120-300-350-400 mm. The stroke of the actuator can be adjusted in millimeters up to 400 mm using the Mowin App.
Position A: WiFi activated - MASTER.



Vasistas
Bottom hung



Sporgere
Top hung



Caratteristiche principali

Main features

Forza

Force

Gli attuatori della serie LIWIN L35 Slim hanno una forza di spinta e trazione massima pari a 350N. Grazie alla funzione di sincronizzazione è possibile ottenere una forza massima totale fino a 1960N.

The LIWIN L35 Slim series actuators have a maximum push and pull force of 350N. Thanks to the synchronization function it is possible to obtain a total maximum force up to 1960N.

QRCode Sync

QRCode Sync

Sincronizzazione di più attuatori, Regolazione parametri, Registrazione e Diagnostica in tempo reale tramite una semplice scansione del QRCode.

Synchronization of multiple actuators, Parameter adjustment, Recording and Diagnostics in real time by simply scanning the QRCode.

Semplicità

Simplicity

Lo spessore ridotto dell'attuatore e le staffe speciali rendono l'installazione semplice e veloce anche in spazi limitati.

The reduced thickness of the actuator and the special brackets make installation quick and easy even in limited spaces.

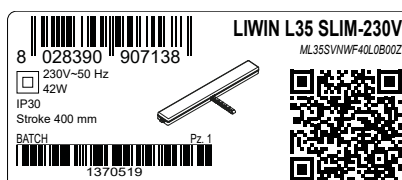

Caratteristiche tecniche / Technical data sheet

	LIWIN L35 Slim - 230 V	LIWIN L35 Slim - 24 V	LIWIN L35 Slim Wi-Fi - 230 V	LIWIN L35 Slim Wi-Fi - 24 V
Forza trazione / Traction force	350 N*	350 N*	350 N*	350 N*
Forza spinta / Thrust force	350 N*	350 N*	350 N*	350 N*
Alimentazione / Power supply	110/230 V	24 V	110/230 V	24 V
Frequenza / Frequency	50/60 hz	-	50/60 hz	-
Tipo di servizio / Type of service	3 min ON 7 min OFF	3 min ON 7 min OFF	3 min ON 7 min OFF	3 min ON 7 min OFF
Velocità a vuoto / Unloaded stroke speed	11 mm/s	11 mm/s	11 mm/s	11mm/s
Corse disponibili / Strokes available	120 - 300 - 350 - 400	120 - 300 - 350 - 400	120 - 300 - 350 - 400 Regolazione millimetrica con app Mowin Millimetric adjustment with Mowin app	120 - 300 - 350 - 400 Regolazione Millimetrica con App Mowin Millimetric adjustment with Mowin app
Temperatura di funzionamento Operating temperature	-5°C + 50°C	-5°C + 50°C	-5°C + 50°C	-5°C + 50°C
Grado di protezione ip Ip protection class	30	30	30	30
Soft START / Soft STOP	Si / Yes	Si / Yes	Si / Yes	Si / Yes
Assorbimento corrente / Current draw	0,4 A	1 A	0,4 A	1 A
Potenza assorbita / Power draw	42 W	24 W	42 W	24 W
Rilevamento ostacolo Obstacle detection	Assorbimento di corrente Current draw	Assorbimento di corrente Current draw	Assorbimento di corrente Current draw	Assorbimento di corrente Current draw
Collegamento in parallelo Connection in parallel	Si / Yes Max 30 attuatori Max 30 actuators	Si / Yes Max 30 attuatori Max 30 actuators	Si / Yes Max 30 attuatori Max 30 actuators	Si / Yes Max 30 attuatori Max 30 actuators
Sincronizzazione / Synchronisation	No	No	Fino a 8 attuatori Up to 8 actuators	Fino a 8 attuatori Up to 8 actuators
Dimensioni / Dimensions	27 x 54 x 440 mm	27 x 54 x 440 mm	27 x 54 x 440 mm	27 x 54 x 440 mm
Finecorsa in apertura / Open limit switch	Encoder	Encoder	Encoder	Encoder
Finecorsa in chiusura / Closed limit switch	Amperometrica Amperometric	Amperometrica Amperometric	Amperometrica Amperometric	Amperometrica Amperometric
Peso attuatore / Actuator weight	1,110 Kg	1,110 Kg	1,110 Kg	1,110 Kg

* Vedi grafici portate pag. 170-171

* See actuators graph pag. 170-171

Resistente

Resistance

La qualità elevata e la robustezza della catena a doppia maglia garantiscono la trasmissione della forza massima sia in trazione che in spinta.

The high quality and sturdiness of the double link chain guarantee the transmission of the maximum force both in traction and in push.

IQ Interconnectivity

IQ Interconnectivity

L'interconnettività IQ è un innovativo sistema di comunicazione wireless. Grazie al dispositivo Wi-Fi posto all'interno del motore è possibile connettersi con l'app MOWIN per una completa configurazione degli attuatori e garantisce una perfetta sincronizzazione tra più attuatori installati sulla stessa finestra.

IQ interconnectivity is an innovative wireless communication system. Thanks to the Wi-Fi device placed inside the motor, it allows you to connect with the MOWIN app for complete configuration of the actuators and guarantee perfect synchronization between multiple actuators installed on the same window.

Diagnostica

Diagnostics

La Mowin App consente sia la registrazione delle ultime manovre con le eventuali anomalie segnalate, sia di effettuare una diagnostica in tempo reale per individuare eventuali errori di malfunzionamento.

L'attuatore è anche dotato di un led in grado di segnalare se ci sono eventuali anomalie.

The Mowin App allows both the recording of the last manoeuvres with any reported anomalies and real-time diagnostics to identify any malfunction errors. The actuator is also equipped with a led able to signal if there are any anomalies.

LIWIN L35 Slim

LIWIN L35 Slim Wi-Fi



One Smart



Mowin App®

24
VDC230
VAC110
VAC

Power



NV



Technology



Agile

Configurazione dell'attuatore

Actuator configuration



Sporgere

Top hung

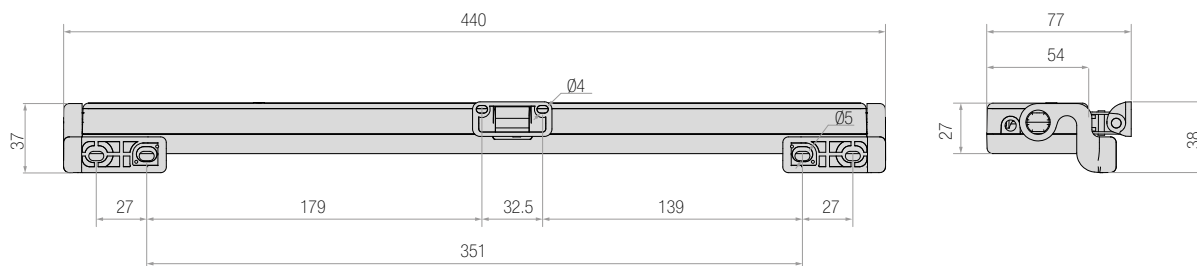

L35 - Angolo di apertura anta a sporgere

L35 - Top hung opening angle

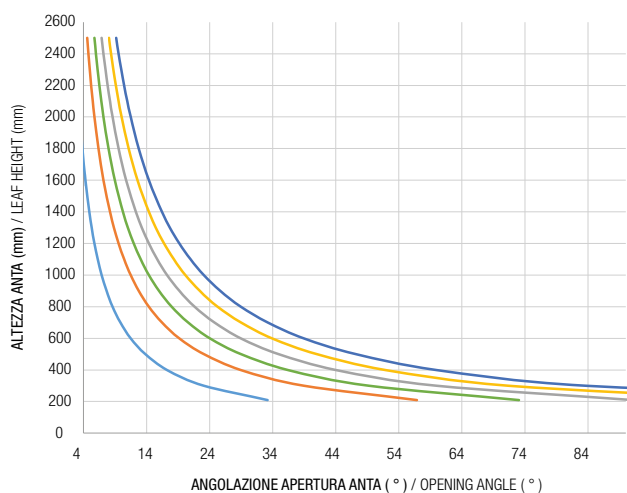

CORSA / STROKE — 120 mm — 200 mm — 250 mm — 300 mm — 350 mm — 400 mm

I valori indicati nei grafici sono da considerarsi indicativi e non considerano eventuali deformazioni dovute a fattori esterni.
The values indicated in the graphs are to be considered indicative and do not consider any deformations due to external factors.

Per scegliere l'attuatore Comunello Mowin più adatto, è necessario calcolare la FORZA (F) necessaria a sostenere il movimento della finestra. Il tipo di attuatore va selezionato considerando la combinazione tra la dimensione di BASE del serramento e la forza calcolata (N).

Per ante con BASE superiore a 1.5 metri, se il serramento è sufficientemente rigido, consigliamo l'installazione di sistemi sincronizzati come illustrato nel paragrafo Sincronizzazione di p.28.

L35 - Portate attuatori a sporgere e cupola

L35 - Actuator force - top hung and dome

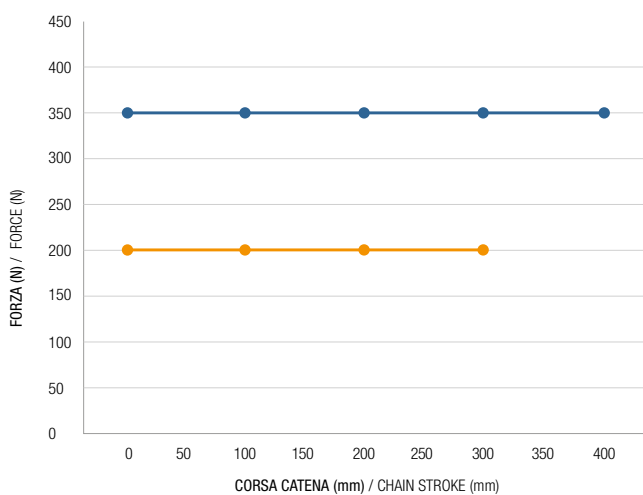

—●— SPORGERE / TOP HUNG OUTWARD OPENING —●— CUPOLA / DOME

In order to choose the most suitable Comunello Mowin actuator, you have to calculate the necessary FORCE (F) to sustain the window movement. Choose the actuator type in accordance with the CALCULATED FORCE (N) and the FRAME DIMENSION.

For leaves with a BASE greater than 1.5 metres, if the window is sufficiently rigid, we recommend the installation of synchronized systems as illustrated in the Synchronization paragraph on p.28.



Vasistas
Bottom hung

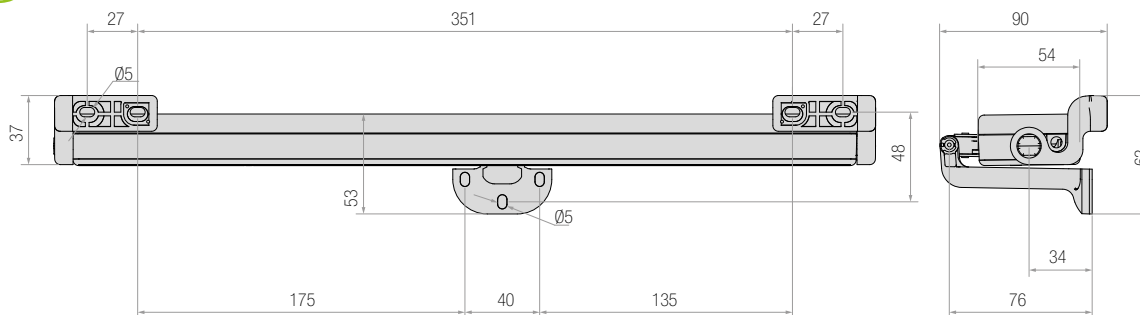

L35 - Angolo di apertura anta vasistas
L35 - Bottom hung opening angle

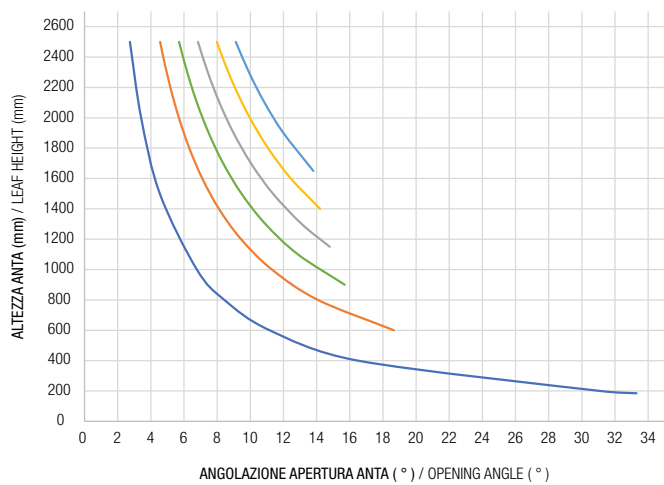

CORSA / STROKE — 120 mm — 200 mm — 250 mm — 300 mm — 350 mm — 400 mm

I valori indicati nei grafici sono da considerarsi indicativi e non considerano eventuali deformazioni dovute a fattori esterni.
The values indicated in the graphs are to be considered indicative and do not consider any deformations due to external factors.

L35 - Portate attuatori vasistas
L35 - Actuator force - bottom hung

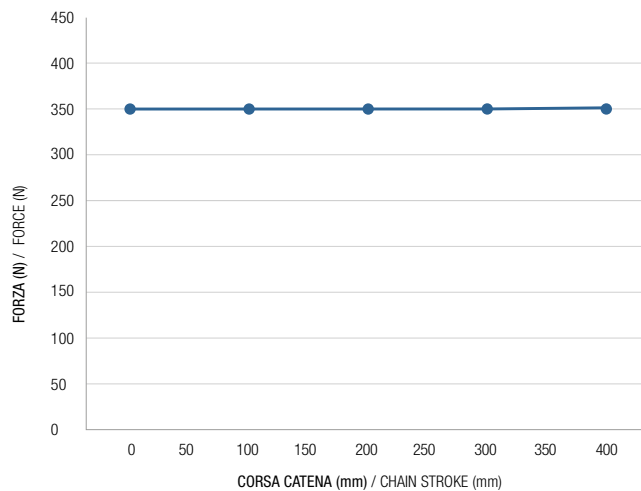

—●— VASISTAS / BOTTOM HUNG INWARD OPENING

Formule per il calcolo della forza necessaria a movimentare il serramento *Formulas for calculating the force necessary to move the window*

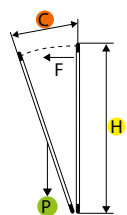

$$\frac{C \div H}{2} \times (P \div 2) = F \text{ Kg}$$

$$F \text{ (Kg)} \times 9,8 = \mathbf{N \text{ (N)}}$$

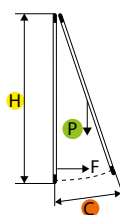

$$\frac{C \div H}{2} \times (P \div 2) = F \text{ Kg}$$

$$F \text{ (Kg)} \times 9,8 = \mathbf{N \text{ (N)}}$$

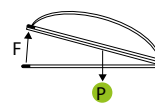

$$P \div 2 = F \text{ Kg}$$

$$F \text{ (Kg)} \times 9,8 = \mathbf{N \text{ (N)}}$$

F = Forza necessaria
Necessary Force (Kg)

C = Corsa di apertura
Opening stroke (mm)

H = Altezza serramento
Window height (mm)

P = Peso serramento
Window weight (Kg)

LIWIN L35 Slim

LIWIN L35 Slim Wi-Fi



One Smart



Mowin App®

24
VDC230
VAC110
VAC

NV



Technology



Agile

Article	Commercial code	Product code	Push / pull*	Strokes	Colour	Power supply	Weight	Pcs
LIWIN L35 Slim	L35-24V	ML35SVNNW40L0B00Z	350 N	120 - 300 - 350 - 400 mm	NERO / Black	24VDC	1,20 kg	1
LIWIN L35 Slim	L35-24V	ML35SVNNW40LOG00Z	350 N	120 - 300 - 350 - 400 mm	GRIGIO / Grey	24VDC	1,20 kg	1
LIWIN L35 Slim	L35-24V	ML35SVNNW40LOW00Z	350 N	120 - 300 - 350 - 400 mm	BIANCO / White	24VDC	1,20 kg	1
LIWIN L35 Slim	L35-24V	ML35SVNNW40L1W00Z	350 N	120 - 300 - 350 - 400 mm	AVORIO / Ivory	24VDC	1,20 kg	1
LIWIN L35 Slim Wi-Fi	L35-24V-WF	ML35SVNWF40L0B00Z	350 N	120 - 300 - 350 - 400 mm	NERO / Black	24VDC	1,20 kg	1
LIWIN L35 Slim Wi-Fi	L35-24V-WF	ML35SVNWF40LOG00Z	350 N	120 - 300 - 350 - 400 mm	GRIGIO / Grey	24VDC	1,20 kg	1
LIWIN L35 Slim Wi-Fi	L35-24V-WF	ML35SVNWF40LOW00Z	350 N	120 - 300 - 350 - 400 mm	BIANCO / White	24VDC	1,20 kg	1
LIWIN L35 Slim Wi-Fi	L35-24V-WF	ML35SVNWF40L1W00Z	350 N	120 - 300 - 350 - 400 mm	AVORIO / Ivory	24VDC	1,20 kg	1
LIWIN L35 Slim	L35-230V	ML35SVNNW40H0B00Z	350 N	120 - 300 - 350 - 400 mm	NERO / Black	110/230VAC	1,20 kg	1
LIWIN L35 Slim	L35-230V	ML35SVNNW40H0G00Z	350 N	120 - 300 - 350 - 400 mm	GRIGIO / Grey	110/230VAC	1,20 kg	1
LIWIN L35 Slim	L35-230V	ML35SVNNW40H0W00Z	350 N	120 - 300 - 350 - 400 mm	BIANCO / White	110/230VAC	1,20 kg	1
LIWIN L35 Slim	L35-230V	ML35SVNNW40H1W00Z	350 N	120 - 300 - 350 - 400 mm	AVORIO / Ivory	110/230VAC	1,20 kg	1
LIWIN L35 Slim Wi-Fi	L35-230V-WF	ML35SVNWF40H0B00Z	350 N	120 - 300 - 350 - 400 mm	NERO / Black	110/230VAC	1,20 kg	1
LIWIN L35 Slim Wi-Fi	L35-230V-WF	ML35SVNWF40H0G00Z	350 N	120 - 300 - 350 - 400 mm	GRIGIO / Grey	110/230VAC	1,20 kg	1
LIWIN L35 Slim Wi-Fi	L35-230V-WF	ML35SVNWF40H0W00Z	350 N	120 - 300 - 350 - 400 mm	BIANCO / White	110/230VAC	1,20 kg	1
LIWIN L35 Slim Wi-Fi	L35-230V-WF	ML35SVNWF40H1W00Z	350 N	120 - 300 - 350 - 400 mm	AVORIO / Ivory	110/230VAC	1,20 kg	1

*Vedi grafici portate attuatori p.170-171 / *See actuator graph p.170-171

La confezione contiene - Box contains:							
	Attuatore <i>Actuator</i>	Staffe Vasistas <i>Vasistas brackets</i>	Staffa a sporgere <i>Top hung bracket</i>	Dima per l'installazione <i>Mounting template</i>	Staffe di supporto <i>Support brackets</i>	Manuale d'uso <i>User manual</i>	



Raywin



Attuatore elettromeccanico a stelo per apertura e chiusura di finestre a sporgere, cupole e pale frangisole. Disponibili nelle versioni 24Vdc e 230Vac gli attuatori modello Raywin possono arrivare a 600N di forza con corsa massima di 500mm. Grazie alla tecnologia W-NET è possibile installare fino a 4 Raywin R60 sincronizzati nella stessa finestra.

Electromechanical rod actuator for opening and closing top hinged windows, domes and sunshade blades. Available in the 24Vdc and 230Vac versions, the Raywin model actuators can reach a force of 600N with a maximum stroke of 500mm. Thanks to W-NET technology it is possible to install up to 4 synchronized Raywin R60s in the same window.





Raywin



Attuatore elettrico a stelo per apertura e chiusura di finestre a sporgere, a lamelle, pale frangisole e cupole.

Electric rod actuator for opening and closing top hinged windows, louvres, sunshade blades and domes.





Raywin R20



One Smart

110
VAC24
VDC230
VAC

Power



NV



Caratteristiche principali

Main features

Installazione

Installation

Fissaggio della staffa regolabile lungo il binario del corpo dell'attuatore.

Fixing of the adjustable bracket along the rail of the actuator body.

Resistenza

Resistance

L'involucro in alluminio e le staffe in acciaio garantiscono un'elevata resistenza.

The aluminum casing and steel brackets guarantee high resistance.

Corse disponibili

Strokes available

Il finecorsa in apertura regolabile è garantito in maniera stabile e precisa dall'encoder.

The adjustable opening limit switch is guaranteed in a stable and precise manner by the encoder.

Caratteristiche tecniche / Technical data sheet

	Raywin R20 - 230 V	Raywin R20 - 24 V
Forza trazione / spinta <i>Thrust/traction force R20</i>	200 N	200 N
Alimentazione / <i>Power supply</i>	110/230 VAC	24 VDC
Frequenza / <i>Frequency</i>	50/60 hz	-
Tipo di servizio / <i>Type of service</i>	≤2 4min	≤2 4min
Velocità a vuoto / <i>Unloaded stroke speed</i>	7 mm/s	7 mm/s
Corse disponibili / <i>Strokes available</i>	105 - 180 - 300	105 - 180 - 300
Temperatura di funzionamento / <i>Operating temperature</i>	-5°c + 50°c	-5°c + 50°c
Grado di protezione IP / <i>IP protection class</i>	4x	4x
Soft START / Soft STOP	Si / Yes	Si / Yes
Assorbimento / potenza R20	0,13 A	0,7 A
Potenza assorbita / <i>Power draw</i>	17 W	41 W
Rilevamento ostacolo / <i>Obstacle detection</i>	Si / Yes	Si / Yes
Collegamento in parallelo / <i>Connection in parallel</i>	Si / Yes (max 30 attuatori / <i>max 30 actuators</i>)	Si / Yes (max 30 attuatori / <i>max 30 actuators</i>)
Sincronizzazione / <i>Synchronisation</i>	No/ No	No / No
Dimensioni / <i>Dimensions</i>	488 x 84 x 48 mm	488 x 84 x 48 mm
Finecorsa in apertura / <i>Open limit switch</i>	Encoder	Encoder
Finecorsa in chiusura / <i>Closed limit switch</i>	Amperometrica / <i>Amperometric</i>	Amperometrica / <i>Amperometric</i>
Peso attuatore / <i>Actuator weight</i>	1,90 Kg	1,90 Kg

Finecorsa chiusura Closing limit switch

Il finecorsa in chiusura per assorbimento di corrente garantisce una chiusura stabile nel tempo.

The closing limit switch by current absorption guarantees stable closure over time.

Collegamenti in parallelo Parallel connections

Collegabile in parallelo fino ad un massimo di 30 attuatori

Can be connected in parallel up to a maximum of 30 actuators.

Regolazioni Adjustments

Regolazione corse tramite combinazione di dip-switch.

Stroke setting by dip-switch combination.

Raywin R20



One Smart

110
VAC24
VDC230
VAC

NV

Configurazione dell'attuatore

Actuator configuration



Sporgere
Top hung

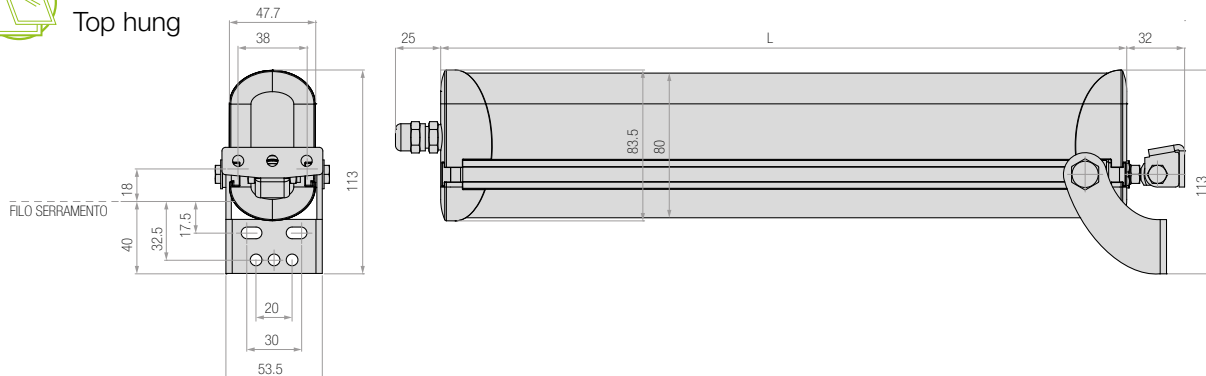

R20 - Angolo di apertura anta a sporgere

R20 - Top hung opening angle

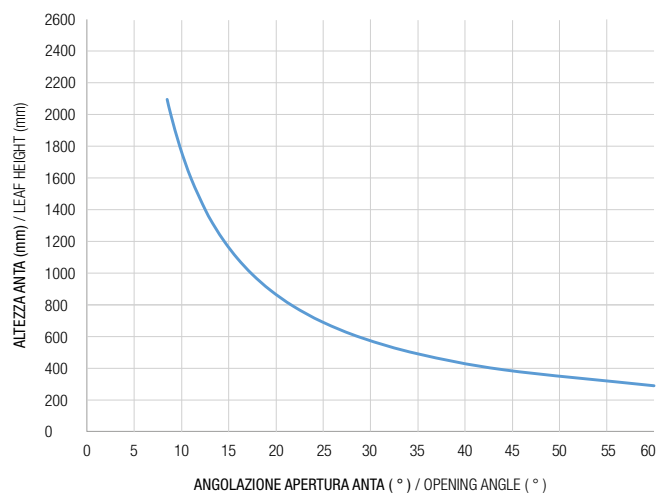

CORSA / STROKE — 300 mm

I valori indicati nei grafici sono da considerarsi indicativi e non considerano eventuali deformazioni dovute a fattori esterni.

The values indicated in the graphs are to be considered indicative and do not consider any deformations due to external factors.

Per scegliere l'attuatore Comunello Mowin più adatto, è necessario calcolare la FORZA (F) necessaria a sostenere il movimento della finestra. Il tipo di attuatore va selezionato considerando la combinazione tra la dimensione di BASE del serramento e la forza calcolata (N).

Formule per il calcolo della forza necessaria a movimentare il serramento

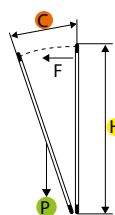

$$\frac{(C \div H) \times (P \div 2) = F \text{ Kg}}{F \text{ (Kg)} \times 9,8 = \mathbf{N F \text{ (N)}}$$

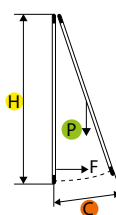

$$\frac{(C \div H) \times (P \div 2) = F \text{ Kg}}{F \text{ (Kg)} \times 9,8 = \mathbf{N F \text{ (N)}}$$

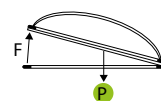

$$\frac{P \div 2 = F \text{ Kg}}{F \text{ (Kg)} \times 9,8 = \mathbf{N F \text{ (N)}}$$

F = Forza necessaria
Necessary Force (Kg)

C = Corsa di apertura
Opening stroke (mm)

H = Altezza serramento
Window height (mm)

P = Peso serramento
Window weight (Kg)

R20 - Portate attuatori a sporgere e cupola



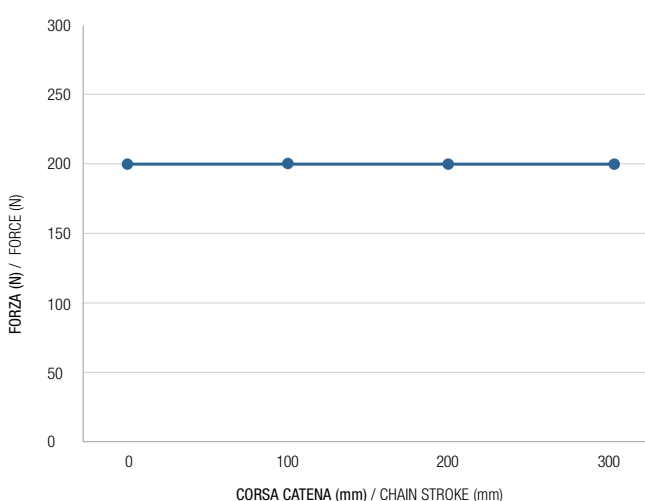

R20 - Actuator force - top hung and dome



— SPORGERE / TOP HUNG OUTWARD OPENING CUPOLA / DOME

In order to choose the most suitable Comunello Mowin actuator, you have to calculate the necessary FORCE (F) to sustain the window movement. Choose the actuator type in accordance with the CALCULATED FORCE (N) and the FRAME DIMENSION.

Formulas for calculating the force necessary to move the window

Article	Product code	Push / pull	Strokes	Colour	Power	Power supply	Weight	Pcs
R20/300 230V basic 	MR20 S1 30H 0G 00	200 N	105 - 180 - 300 mm	Grey RAL 7035 	17W	230 VAC	1,90 Kg	1
R20/300 24V basic 	MR20 S1 30L 0G 00	200 N	105 - 180 - 300 mm	Grey RAL 7035 	41W	24 VDC	1,90 Kg	1

	La confezione contiene:	Box contains:		
	Attuatore <i>Actuator</i> 	Staffe di supporto <i>Support brackets</i> 	Attacco per finestre <i>Fitting for windows</i> 	Manuale d'uso <i>User manual</i> 

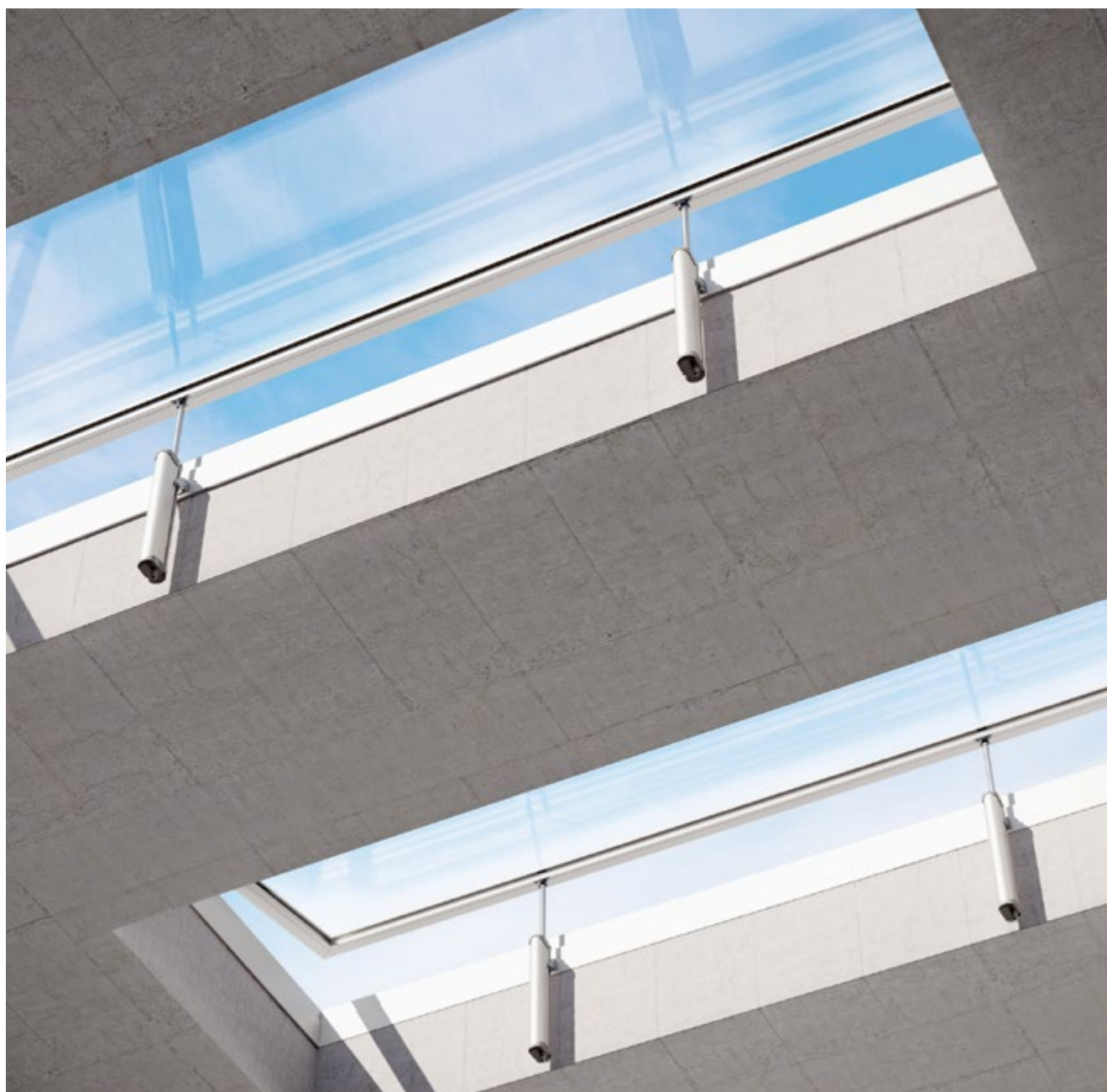

Raywin R45



One Smart

110
VAC24
VDC230
VAC

Power



NV



Caratteristiche principali

Main features

Installazione

Installation

Fissaggio della staffa regolabile lungo il binario del corpo dell'attuatore.

Fixing of the adjustable bracket along the rail of the actuator body.

Resistenza

Resistance

L'involucro in alluminio e le staffe in acciaio garantiscono un'elevata resistenza.

The aluminum casing and steel brackets guarantee high resistance.

Corse disponibili

Strokes available

Il finecorsa in apertura regolabile è garantito in maniera stabile e precisa dall'encoder.

The adjustable opening limit switch is guaranteed in a stable and precise manner by the encoder.

Caratteristiche tecniche / Technical data sheet

	Raywin R45 - 230 V	Raywin R45 - 24 V
Forza trazione / spinta Thrust/traction force	450 N	450 N
Alimentazione / Power supply	110/230 VAC	24 VDC
Frequenza / Frequency	50/60 hz	-
Tipo di servizio / Type of service	s2 4min	s2 4min
Velocità a vuoto / Unloaded stroke speed	7 mm/s	7 mm/s
Corse disponibili / Strokes available	70 - 160 - 200 - 235 - 300 - 400	70 - 160 - 200 - 235 - 300 - 400
Temperatura di funzionamento / Operating temperature	-5°C + 50°C	-5°C + 50°C
Grado di protezione IP / IP protection class	4X	4X
Soft START / Soft STOP	Si / Yes	Si / Yes
Assorbimento / potenza Rated Current / Power	0,23 A	1,2 A
Potenza assorbita / Power draw	29 W	41 W
Rilevamento ostacolo / Obstacle detection	Si / Yes	Si / Yes
Collegamento in parallelo / Connection in parallel	Si / Yes (max 30 attuatori / max 30 actuators)	Si / Yes (max 30 attuatori / max 30 actuators)
Sincronizzazione / Synchronisation	No / No	No / No
Dimensioni / Dimensions	L x 84 x 48 mm	L x 84 x 48 mm
Finecorsa in apertura / Open limit switch	Encoder	Encoder
Finecorsa in chiusura / Closed limit switch	Amperometrica / Amperometric	Amperometrica / Amperometric
Peso attuatore / Weight of actuator	Variabile secondo la corsa / Variable according to stroke	Variabile secondo la corsa / Variable according to stroke

Finecorsa chiusura

Closing limit switch

Il finecorsa in chiusura per assorbimento di corrente garantisce una chiusura stabile nel tempo.

The closing limit switch by current absorption guarantees stable closure over time.

Collegamenti in parallelo

Parallel connections

Collegabile in parallelo fino ad un massimo di 30 attuatori.

Can be connected in parallel up to a maximum of 30 actuators.

Regolazioni

Adjustments

Regolazione corse tramite combinazione di dip-switch.

Stroke setting by dip-switch combination.

Raywin R45



One Smart

110
VAC24
VDC230
VAC

NV

Configurazione dell'attuatore

Actuator configuration



Spingere
Top hung

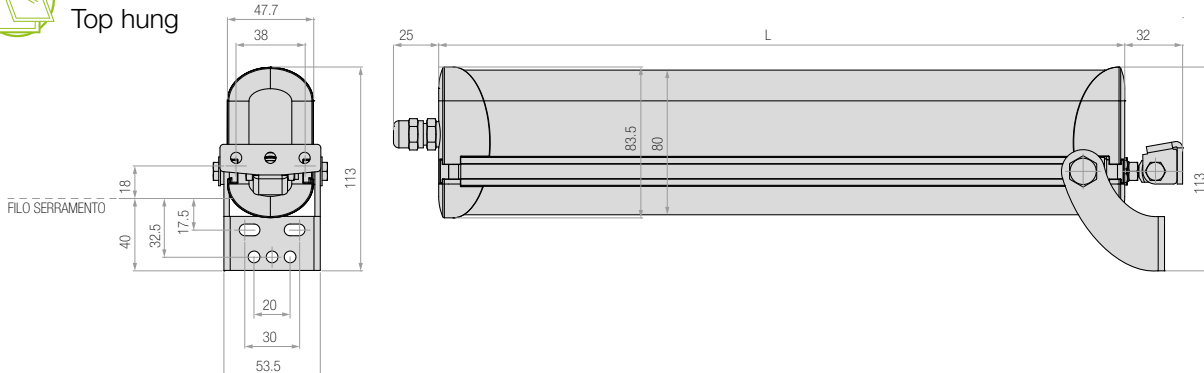

R45 - Angolo di apertura anta a spingere

R45 - Top hung opening angle

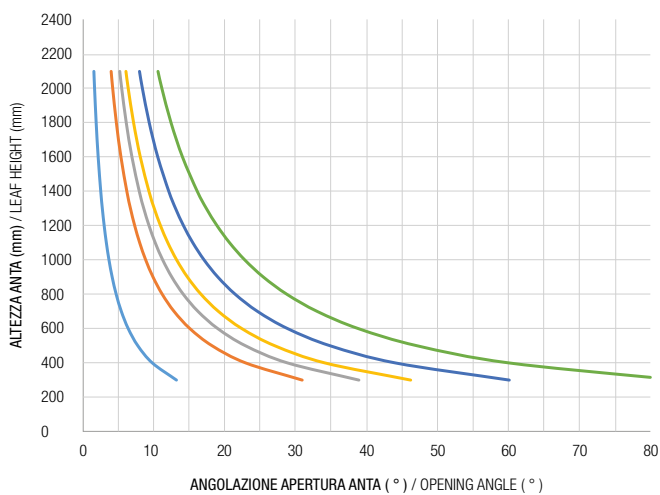

CORSA / STROKE — 70 mm — 160 mm — 200 mm — 235 mm — 300 mm — 400 mm

I valori indicati nei grafici sono da considerarsi indicativi e non considerano eventuali deformazioni dovute a fattori esterni.

The values indicated in the graphs are to be considered indicative and do not consider any deformations due to external factors.

R45 - Portate attuatori a spingere

R45 - Actuator force - top hung

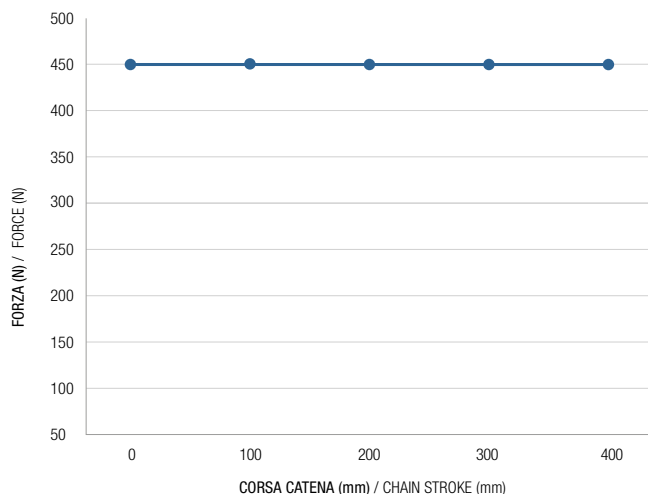

● SPORGERE / TOP HUNG OUTWARD OPENING CUPOLA / DOME

Per scegliere l'attuatore Comunello Mowin più adatto, è necessario calcolare la FORZA (F) necessaria a sostenere il movimento della finestra. Il tipo di attuatore va selezionato considerando la combinazione tra la dimensione di BASE del serramento e la forza calcolata (N).

In order to choose the most suitable Comunello Mowin actuator, you have to calculate the necessary FORCE (F) to sustain the window movement. Choose the actuator type in accordance with the CALCULATED FORCE (N) and the FRAME DIMENSION.

Formule per il calcolo della forza necessaria a movimentare il serramento

Formulas for calculating the force necessary to move the window

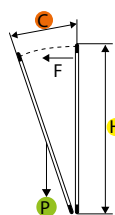

$$\frac{(C \div H) \times (P \div 2) = F \text{ Kg}}{F \text{ (Kg)} \times 9,8 = \mathbf{N F \text{ (N)}}$$

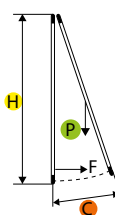

$$\frac{(C \div H) \times (P \div 2) = F \text{ Kg}}{F \text{ (Kg)} \times 9,8 = \mathbf{N F \text{ (N)}}$$

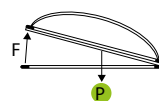













$$\frac{P \div 2 = F \text{ Kg}}{F \text{ (Kg)} \times 9,8 = \mathbf{N F \text{ (N)}}$$

F = Forza necessaria
Necessary Force (Kg)

C = Corsa di apertura
Opening stroke (mm)

H = Altezza serramento
Window height (mm)

P = Peso serramento
Window weight (Kg)

Article	Product code	Push / pull	Strokes	Lenght L	Colour	Power	Power supply	Weight	Pcs
R45/200 230V basic 	MR45 S1 20H 0G 00	450 N	70 - 160 - 200 mm	420 mm	Grey RAL 7035 	29W	230 VAC	1,90 Kg	1
R45/300 230V basic 	MR45 S1 30H 0G 00	450 N	235 - 300 mm	420 mm	Grey RAL 7035 	29W	230 VAC	1,90 Kg	1
R45/400 230V basic 	MR45 S1 40H 0G 00	450 N	400 mm	520 mm	Grey RAL 7035 	29W	230 VAC	2,30 Kg	1
R45/200 24V basic 	MR45 S1 20L 0G 00	450 N	70 - 160 - 200 mm	420 mm	Grey RAL 7035 	41W	24 VDC	1,90 Kg	1
R45/300 24V basic 	MR45 S1 30L 0G 00	450 N	235 - 300 mm	420 mm	Grey RAL 7035 	41W	24 VDC	1,90 Kg	1
R45/400 24V basic 	MR45 S1 40L 0G 00	450 N	400 mm	520 mm	Grey RAL 7035 	41W	24 VDC	2,30 Kg	1

	La confezione contiene:	Box contains:		
	Aattuatore <i>Actuator</i> 	Staffe di supporto <i>Support brackets</i> 	Attacco per finestre <i>Fitting for windows</i> 	Manuale d'uso <i>User manual</i> 



Raywin R60

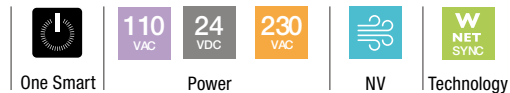

Caratteristiche principali

Main features

Installazione

Installation

Fissaggio della staffa regolabile lungo il binario del corpo dell'attuatore.

Fixing of the adjustable bracket along the rail of the actuator body.

Tecnologia W-Net

W-Net Technology

Grazie alla tecnologia W-Net è possibile installare fino a 4 attuatori sincronizzati nello stesso serramento.

Thanks to the W-Net technology it is possible to install up to 4 synchronized actuators in the same window.

Finecorsa apertura

Opening limit switch

Il finecorsa in apertura regolabile è garantito in maniera stabile e precisa dall'encoder.

The adjustable opening limit switch is guaranteed in a stable and precise manner by the encoder.

Caratteristiche tecniche / Technical data sheet

Forza trazione / spinta <i>Thrust/traction force</i>	600 N	600 N
Alimentazione / <i>Power supply</i>	110/230 VAC	24 VDC
Frequenza / <i>Frequency</i>	50/60 hz	-
Tipo di servizio / <i>Type of service</i>	s2 4min	s2 4min
Velocità a vuoto / <i>Unloaded stroke speed</i>	7 mm/s	7 mm/s
Corse disponibili / <i>Strokes available</i>	180 - 225 - 300 - 500	180 - 225 - 300 - 500
Temperatura di funzionamento <i>Operating temperature</i>	-5°C + 50°C	-5°C + 50°C
Grado di protezione IP / <i>IP protection class</i>	4X	4X
Soft START / Soft STOP	Si / Yes	Si / Yes
Assorbimento / potenza <i>Rated Current / Power</i>	0,23 A	1,7 A
Potenza assorbita / <i>Power draw</i>	29 W	41 W
Rilevamento ostacolo / <i>Obstacle detection</i>	Si / Yes	Si / Yes
Collegamento in parallelo / <i>Connection in parallel</i>	Si / Yes (max 30 attuatori / <i>max 30 actuators</i>)	Si / Yes (max 30 attuatori / <i>max 30 actuators</i>)
Sincronizzazione / <i>Synchronisation</i>	Si / Yes	Si / Yes
Dimensioni / <i>Dimensions</i>	L x 84 x 48 mm	L x 84 x 48 mm
Finecorsa in apertura / <i>Open limit switch</i>	Encoder	Encoder
Finecorsa in chiusura / <i>Closed limit switch</i>	Amperometrica / <i>Amperometric</i>	Amperometrica / <i>Amperometric</i>
Peso attuatore / <i>Actuator weight</i>	Variabile secondo la corsa / <i>Variable according to stroke</i>	Variabile secondo la corsa / <i>Variable according to stroke</i>

Finecorsa chiusura

Closing limit switch

Il finecorsa in chiusura per assorbimento di corrente garantisce una chiusura stabile nel tempo.

The closing limit switch by current absorption guarantees stable closure over time

Forza

Force

Grazie alla forza di 600N di un singolo attuatore è possibile raggiungere una forza totale di 1680N con 4 RAIWIN R60 sincronizzati.

Thanks to the force of 600N of a single actuator it is possible to reach a total force of 1680N with 4 synchronized RAIWIN R60.

Regolazioni

Adjustments

Regolazione corse tramite combinazione di dip-switch.

Stroke setting by dip-switch combination.

Raywin R60

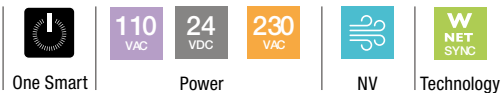

Configurazione dell'attuatore Actuator configuration



Sporgere
Top hung

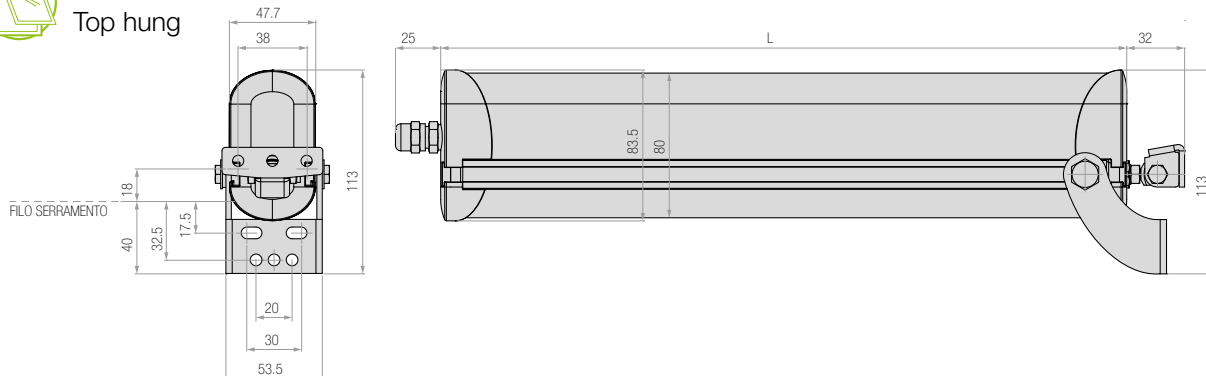

R60 - Angolo di apertura anta a sporgere R60 - Top hung opening angle

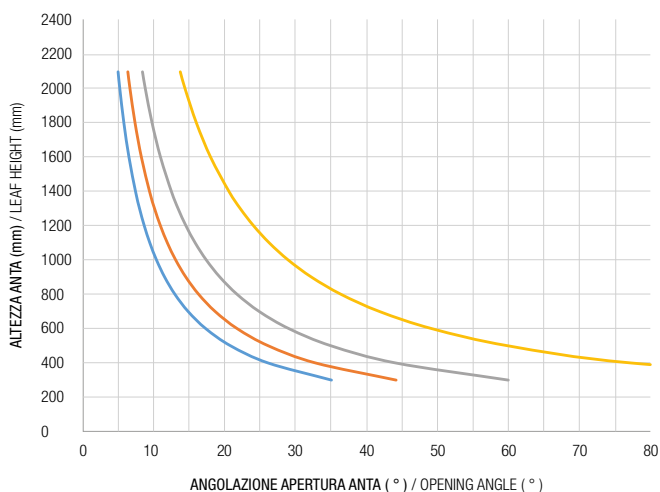

CORSA / STROKE — 180 mm — 225 mm — 300 mm — 500 mm

I valori indicati nei grafici sono da considerarsi indicativi e non considerano eventuali deformazioni dovute a fattori esterni.
The values indicated in the graphs are to be considered indicative and do not consider any deformations due to external factors.

Per scegliere l'attuatore Comunello Mowin più adatto, è necessario calcolare la FORZA (F) necessaria a sostenere il movimento della finestra. Il tipo di attuatore va selezionato considerando la combinazione tra la dimensione di BASE del serramento e la forza calcolata (N).

Formule per il calcolo della forza necessaria a movimentare il serramento

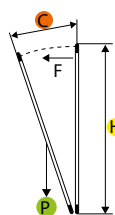

$$\frac{(C \div H) \times (P \div 2) = F \text{ Kg}}{F \text{ (Kg)} \times 9,8 = N \text{ (N)}}$$

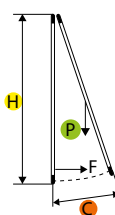

$$\frac{(C \div H) \times (P \div 2) = F \text{ Kg}}{F \text{ (Kg)} \times 9,8 = N \text{ (N)}}$$

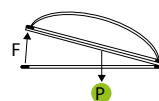

$$\frac{P \div 2 = F \text{ Kg}}{F \text{ (Kg)} \times 9,8 = N \text{ (N)}}$$

F = Forza necessaria
Necessary Force (Kg)

C = Corsa di apertura
Opening stroke (mm)

H = Altezza serramento
Window height (mm)

P = Peso serramento
Window weight (Kg)

R60 - Portate attuatori a sporgere e cupola R60 - Actuator force - top hung and dome

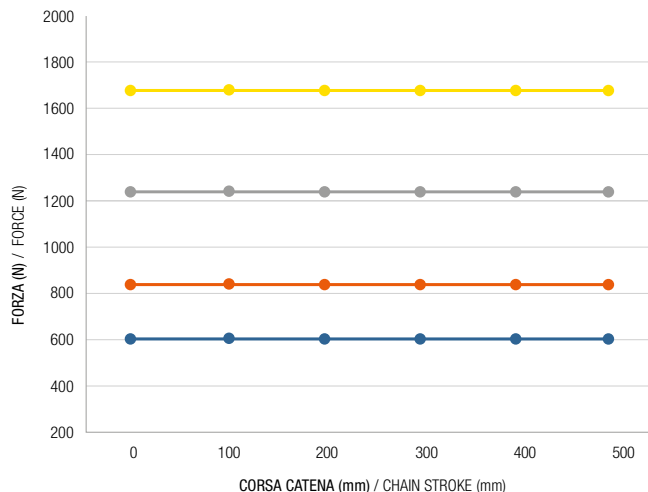

— SPORGERE / TOP HUNG OUTWARD OPENING CUPOLA / DOME
— SPORGERE / TOP HUNG OUTWARD OPENING CUPOLA 2W NET / DOME 2W NET
— SPORGERE / TOP HUNG OUTWARD OPENING CUPOLA 3W NET / DOME 3W NET
— SPORGERE / TOP HUNG OUTWARD OPENING CUPOLA 4W NET / DOME 4W NET

In order to choose the most suitable Comunello Mowin actuator, you have to calculate the necessary FORCE (F) to sustain the window movement. Choose the actuator type in accordance with the CALCULATED FORCE (N) and the FRAME DIMENSION.

Formulas for calculating the force necessary to move the window

Raywin R60

Article	Product code	Push / pull	Strokes	Lenght L	Colour	Power	Power supply	Weight	Pcs
R60/300 230V basic	MR60 S1 30H OG 00	600 N	180-225-300 mm	420 mm	Grey RAL 7035	41W	230 VAC	1,90 Kg	1
R60/500 230V basic	MR60 S1 50H OG 00	600 N	500 mm	620 mm	Grey RAL 7035	41W	230 VAC	2,30 Kg	1
R60/300 24V basic	MR60 S1 30L OG 00	600 N	180-225-300 mm	420 mm	Grey RAL 7035	41W	24 VDC	1,90 Kg	1
R60/500 24V basic	MR60 S1 50L OG 00	600 N	500 mm	620 mm	Grey RAL 7035	41W	24 VDC	2,30 Kg	1

Raywin R60 2W-NET

Article	Product code	Push / pull	Strokes	Colour	Power	Power supply	Weight	Pcs
R60/300 230V 2W-NET	MR60 S2 30H OG 00	600 N	180 - 225 - 300 mm	Grey RAL 7035	41W	230 VAC	3,80 Kg	1
R60/500 230V 2W-NET	MR60 S2 50H OG 00	600 N	500 mm	Grey RAL 7035	41W	230 VAC	4,60 Kg	1
R60/300 24V 2W-NET	MR60 S2 30L OG 00	600 N	180 - 225 - 300 mm	Grey RAL 7035	41W	24 VDC	3,80 Kg	1
R60/500 24V 2W-NET	MR60 S2 50L OG 00	600 N	500 mm	Grey RAL 7035	41W	24 VDC	4,60 Kg	1

Raywin R60 3W-NET

Article	Product code	Push / pull	Strokes	Colour	Power	Power supply	Weight	Pcs
R60/300 230V 3W-NET	MR60 S3 30H OG 00	600 N	180 - 225 - 300 mm	Grey RAL 7035	41W	230 VAC	5,70 Kg	1
R60/500 230V 3W-NET	MR60 S3 50H OG 00	600 N	500 mm	Grey RAL 7035	41W	230 VAC	6,90 Kg	1
R60/300 24V 3W-NET	MR60 S3 30L OG 00	600 N	180 - 225 - 300 mm	Grey RAL 7035	41W	24 VDC	5,70 Kg	1
R60/500 24V 3W-NET	MR60 S3 50L OG 00	600 N	500 mm	Grey RAL 7035	41W	24 VDC	6,90 Kg	1

Raywin R60 4W-NET

Article	Product code	Push / pull	Strokes	Colour	Power	Power supply	Weight	Pcs
R60/300 230V 4W-NET	MR60 S4 30H OG 00	600 N	180 - 225 - 300 mm	Grey RAL 7035	41W	230 VAC	7,60 Kg	1
R60/500 230V 4W-NET	MR60 S4 50H OG 00	600 N	500 mm	Grey RAL 7035	41W	230 VAC	9,20 Kg	1
R60/300 24V 4W-NET	MR60 S4 30L OG 00	600 N	180 - 225 - 300 mm	Grey RAL 7035	41W	24 VDC	7,60 Kg	1
R60/500 24V 4W-NET	MR60 S4 50L OG 00	600 N	500 mm	Grey RAL 7035	41W	24 VDC	9,20 Kg	1

La confezione contiene:		Box contains:		
	Aattuatore <i>Actuator</i>	Staffe di supporto <i>Support brackets</i>	Attacco per finestre <i>Fitting for windows</i>	Manuale d'uso <i>User manual</i>
				

Raywin R60 Regulator



One Smart

110
VAC24
VDC230
VAC

Power



NV



Caratteristiche principali

Main features

Installazione

Installation

Fissaggio della staffa regolabile lungo il binario del corpo dell'attuatore.

Fixing of the adjustable bracket along the rail of the actuator body.

Resistenza

Resistance

L'involucro in alluminio e le staffe in acciaio garantiscono un'elevata resistenza.

The aluminum casing and steel brackets guarantee high resistance.

Finecorsa apertura

Opening limit switch

Il finecorsa in apertura regolabile è garantito in maniera stabile e precisa dall'encoder.

The adjustable opening limit switch is guaranteed in a stable and precise manner by the encoder.

Caratteristiche tecniche / Technical data sheet

	R60/0-300R - 230 V	R60/0-300R - 24 V	R60/0-500R - 230 V	R60/0-500R - 24 V
Forza trazione / Traction force	600 N	600 N	600 N	600 N
Forza spinta / Thrust force	600 N	600 N	600 N	600 N
Alimentazione / Power supply	110/230 VAC	24 VDC	110/230 VAC	24 VDC
Frequenza / Frequency	50/60 hz	-	50/60 hz	-
Tipo di servizio / Type of service	s2 4min	s2 4min	s2 4min	s2 4min
Velocità a vuoto / Unloaded stroke speed	7 mm/s	7 mm/s	7 mm/s	7 mm/s
Corse disponibili / Strokes available	0 - 300	0 - 300	0 - 500	0 - 500
Temperatura di funzionamento Operating temperature	-5°c + 50°c	-5°c + 50°c	-5°c + 50°c	-5°c + 50°c
Grado di protezione IP IP protection class	4X	4X	4X	4X
Soft START / Soft STOP	Si / Yes	Si / Yes	Si / Yes	Si / Yes
Assorbimento corrente / Current draw	0,23 A	1,7 A	0,23 A	1,7 A
Potenza assorbita / Power draw	29 W	41 W	29 W	41 W
Rilevamento ostacolo Obstacle detection	Si / Yes	Si / Yes	Si / Yes	Si / Yes
Collegamento in parallelo Connection in parallel	Si / Yes Max 30 attuatori Max 30 actuators	Si / Yes Max 30 attuatori Max 30 actuators	Si / Yes Max 30 attuatori Max 30 actuators	Si / Yes Max 30 attuatori Max 30 actuators
Sincronizzazione / Synchronisation	No / No	No / No	No / No	No / No
Dimensioni / Dimensions	420 x 84 x 48 mm	420 x 84 x 48 mm	620 x 84 x 48 mm	620 x 84 x 48 mm
Finecorsa in apertura / Open limit switch	Encoder	Encoder	Encoder	Encoder
Finecorsa in chiusura / Closed limit switch	Amperometrica Amperometric	Amperometrica Amperometric	Amperometrica Amperometric	Amperometrica Amperometric
Peso attuatore / Actuator weight	1,90 Kg	1,90 Kg	2,30 Kg	2,30 Kg

Regolazione millimetrica

Millimeter adjustment

La versione R60 REGULATOR permette mediante dip-switch di effettuare una regolazione della corsa millimetrica anche ad installazione completata.

The R60 REGULATOR version allows by means of dip-switches to carry out a millimeter stroke adjustment even after installation is completed.

Finecorsa chiusura

Closing limit switch

Il finecorsa in chiusura per assorbimento di corrente garantisce una chiusura stabile nel tempo.

The closing limit switch by current absorption guarantees stable closure over time.

Collegamenti in parallelo

Parallel connections

Collegabile in parallelo fino ad un massimo di 30 attuatori.

Can be connected in parallel up to a maximum of 30 actuators.

Raywin R60 Regulator



One Smart



110 VAC



24 VDC



230 VAC



NV

Configurazione dell'attuatore

Actuator configuration



Sporgere
Top hung

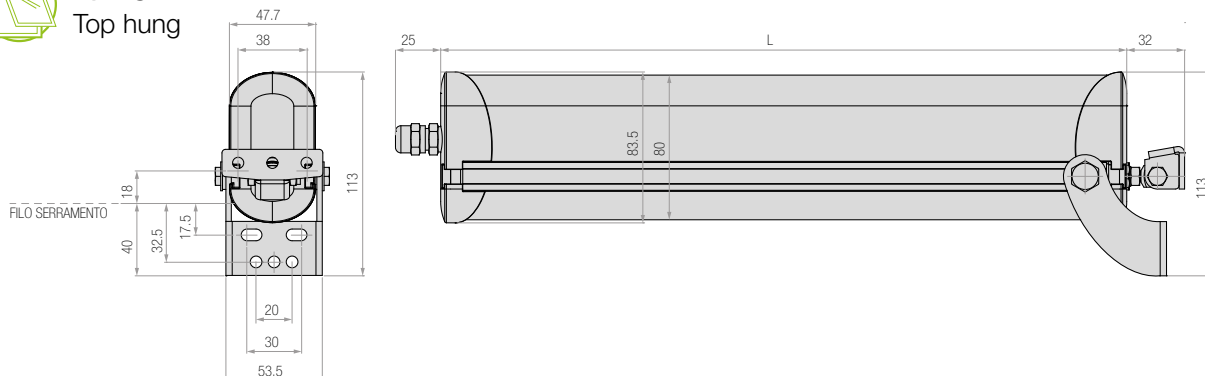

R60 Reg. - Angolo di apertura anta a sporgere

R60 Reg. - Top hung opening angle

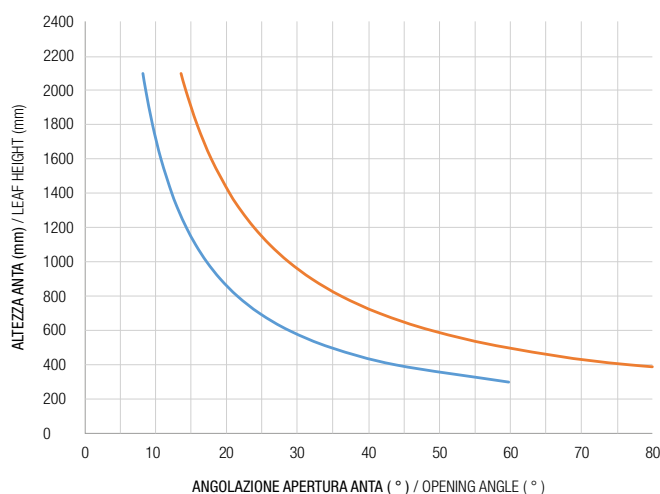

CORSA / STROKE — 300 mm — 500 mm

I valori indicati nei grafici sono da considerarsi indicativi e non considerano eventuali deformazioni dovute a fattori esterni.

Per scegliere l'attuatore Comunello Mowin più adatto, è necessario calcolare la FORZA (F) necessaria a sostenere il movimento della finestra. Il tipo di attuatore va selezionato considerando la combinazione tra la dimensione di BASE del serramento e la forza calcolata (N).

Formule per il calcolo della forza necessaria a movimentare il serramento

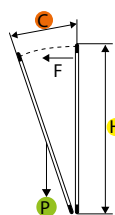

$$\frac{(C \div H) \times (P \div 2) = F \text{ Kg}}{F \text{ (Kg)} \times 9,8 = \mathbf{N F \text{ (N)}}$$

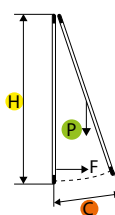

$$\frac{(C \div H) \times (P \div 2) = F \text{ Kg}}{F \text{ (Kg)} \times 9,8 = \mathbf{N F \text{ (N)}}$$

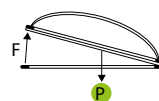

$$\frac{P \div 2 = F \text{ Kg}}{F \text{ (Kg)} \times 9,8 = \mathbf{N F \text{ (N)}}$$

F = Forza necessaria
Necessary Force (Kg)

C = Corsa di apertura
Opening stroke (mm)

H = Altezza serramento
Window height (mm)

P = Peso serramento
Window weight (Kg)

R60 Reg. - Portate attuatori a sporgere e cupola

R60 Reg. - Actuator force - top hung and dome

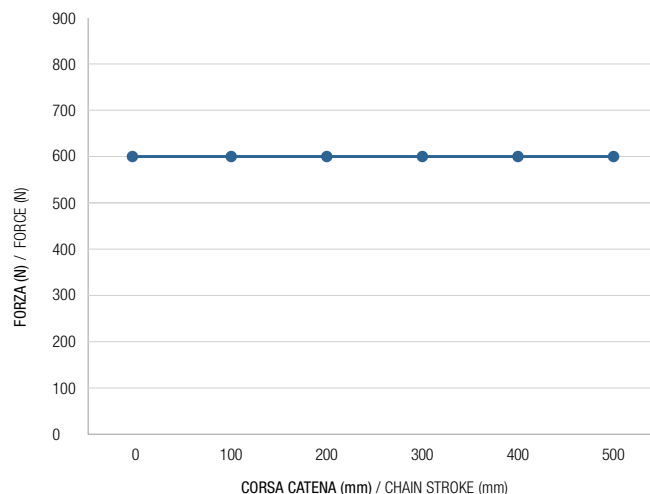









— SPORGERE / TOP HUNG OUTWARD OPENING

In order to choose the most suitable Comunello Mowin actuator, you have to calculate the necessary FORCE (F) to sustain the window movement. Choose the actuator type in accordance with the CALCULATED FORCE (N) and the FRAME DIMENSION.

Formulas for calculating the force necessary to move the window



Article	Product code	Push / pull	Strokes	Lenght L	Colour	Power	Power supply	Weight	Pcs
R60/0-300R 230V basic 	MR60 S1 03H 0G 00	600 N	0 - 300 mm	420 mm	Grigio / Grey 	41W	230 VAC	1,90 Kg	1
R60/0-500R 230V basic 	MR60 S1 05H 0G 00	600 N	0 - 500 mm	620 mm	Grigio / Grey 	41W	230 VAC	2,30 Kg	1
R60/0-300R 24V basic 	MR60 S1 03L 0G 00	600 N	0 - 300 mm	420 mm	Grigio / Grey 	41W	24 VDC	1,90 Kg	1
R60/0-500R 24V basic 	MR60 S1 05L 0G 00	600 N	0 - 500 mm	620 mm	Grigio / Grey 	41W	24 VDC	2,30 Kg	1

La confezione contiene:		Box contains:		
	Attuatore <i>Actuator</i> 	Staffe di supporto <i>Support brackets</i> 	Attacco per finestre <i>Fitting for windows</i> 	Manuale d'uso <i>User manual</i> 



Airwin



L'attuatore elettromeccanico a cremagliera Airwin può raggiungere una corsa massima di 1000mm mantenendo una forza in trazione e spinta di 650N. La versione A65 è dotata del sistema di sincronizzazione w-net che permette di installare fino a 4 attuatori sincronizzati nella stessa finestra. Disponibile nelle versioni 24Vdc e 230Vac, se accoppiato con l'accessorio Airwin mech, diventa una soluzione particolarmente adatta ad applicazioni su infissi di grandi dimensioni dove sono necessari più punti spinta.

The Airwin rack electromechanical actuator can reach a maximum stroke of 1000mm while maintaining a push and pull force of 650N. The A65 version is equipped with the w-net synchronization system which allows you to install up to 4 synchronized actuators in the same window. Available in the 24Vdc and 230Vac versions, if coupled with the Airwin mech accessory, it becomes a particularly suitable solution for applications on large window frames where more push points are required.





Airwin



Attuatore elettrico a cremagliera per apertura e chiusura di Shed, lucernai, pale frangisole e cupole

Electric rack actuator for opening and closing Sheds, skylights, sunshade blades and domes





Airwin A45



One Smart

24
VDC230
VAC

Power



NV

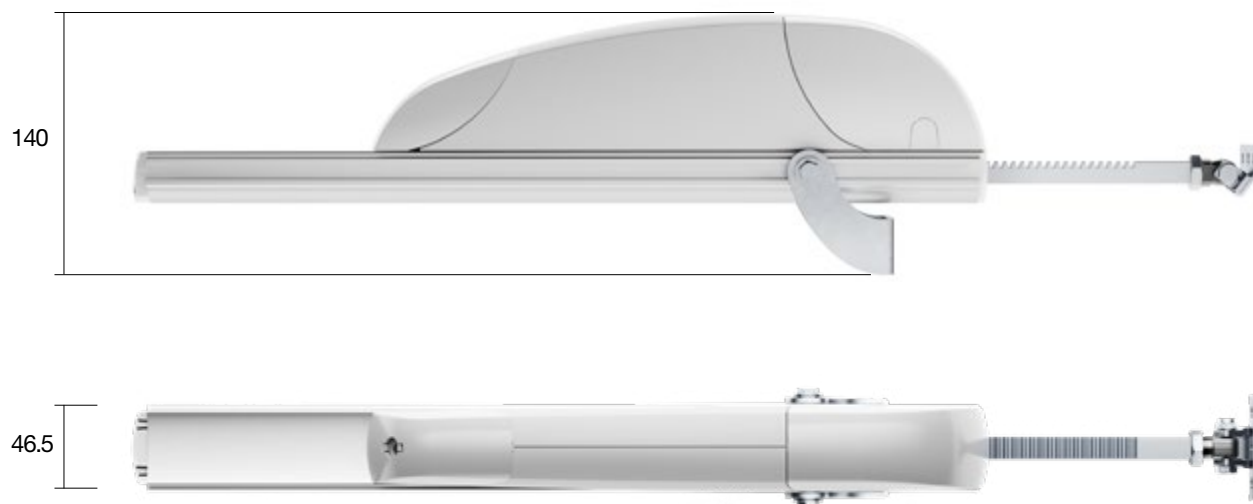

Caratteristiche principali

Main features

Installazione

Installation

Fissaggio della staffa regolabile lungo il binario del corpo dell'attuatore.

Fixing of the adjustable bracket along the rail of the actuator body.

Resistenza

Resistance

L'involucro in alluminio e le staffe in acciaio garantiscono un'elevata resistenza.

The aluminum casing and steel brackets guarantee high resistance.

Finecorsa apertura

Opening limit switch

Il finecorsa in apertura regolabile è garantito in maniera stabile e precisa dall'encoder.

The adjustable opening limit switch is guaranteed in a stable and precise manner by the encoder.

Caratteristiche tecniche / Technical data sheet

	Airwin A45 - 230 V	Airwin A45 - 24 V
Forza trazione / spinta / Thrust/traction force	450 N	450 N
Alimentazione / Power supply	230 VAC	24 VDC
Frequenza / Frequency	50 hz	-
Tipo di servizio / Type of service	s2 4min	s2 4min
Velocità a vuoto / Unloaded stroke speed	10 mm/s	10 mm/s
Corse disponibili / Strokes available	180 - 230 - 350 - 550 750 - 1000	180 - 230 - 350 - 550 750 - 1000
Temperatura di funzionamento / Operating temperature	-5°C + 50°C	-5°C + 50°C
Grado di protezione IP / IP protection class	44	44
Soft START / Soft STOP	Sì / Yes	Sì / Yes
Assorbimento / Current draw	0,29 A	1,5 A
Potenza assorbita / Power draw	36 W	36 W
Rilevamento ostacolo / Obstacle detection	Sì / Yes	Sì / Yes
Collegamento in parallelo / Connection in parallel	Sì / Yes (max 30 attuatori / max 30 actuators)	Sì / Yes (max 30 attuatori / max 30 actuators)
Sincronizzazione / Synchronisation	No / No	No / No
Dimensioni / Dimensions	L x 103 x 47 mm	L x 103 x 47 mm
Finecorsa in apertura / Open limit switch	Encoder	Encoder
Finecorsa in chiusura / Closed limit switch	Amperometrica / Amperometric	Amperometrica / Amperometric
Peso attuatore / Actuator weight	Variabile secondo la corsa Variable according to the stroke	Variabile secondo la corsa Variable according to the stroke

Finecorsa chiusura

Closing limit switch

Il finecorsa in chiusura per assorbimento di corrente garantisce una chiusura stabile nel tempo.

The closing limit switch by current absorption guarantees stable closure over time.

Collegamenti in parallelo

Parallel connections

Collegabile in parallelo fino ad un massimo di 30 attuatori.

Can be connected in parallel up to a maximum of 30 actuators.

A-Mech

È possibile collegare meccanicamente all'attuatore 1 o 2 cremagliere AIRWIN A MECH per ottenere un sistema a 2 o 3 punti spinta e garantire una chiusura più omogenea lungo tutta la lunghezza del serramento.

It is possible to mechanically connect 1 or 2 AIRWIN A MECH racks to the actuator to obtain a 2 or 3-point thrust system and ensure more uniform closure along the entire length of the window.

Airwin A45

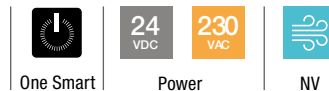

Configurazione dell'attuatore

Actuator configuration



Sporgere
Top hung

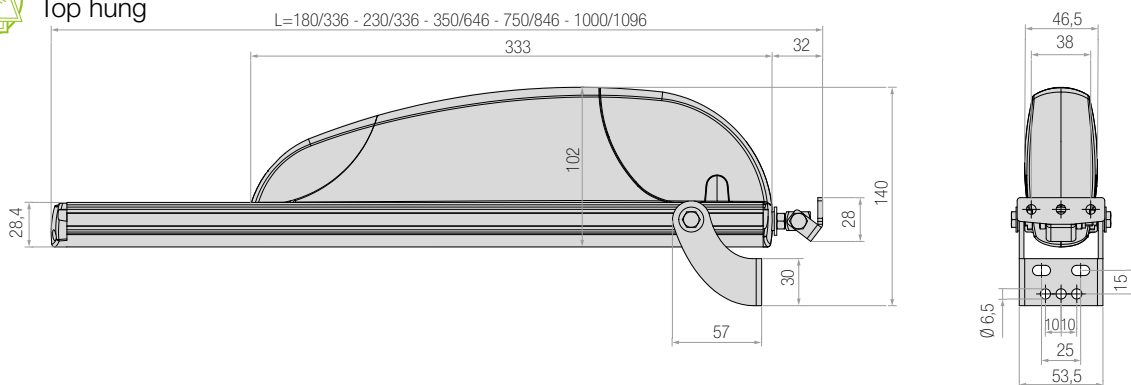

A45 - Angolo di apertura anta a sporgere

A45 - Top hung opening angle

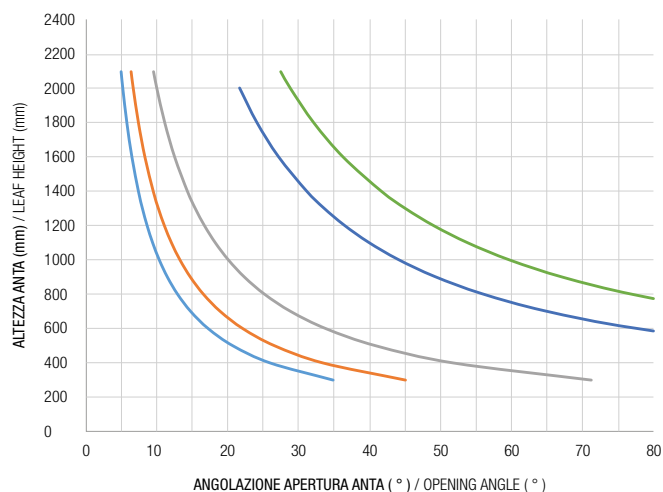

CORSA / STROKE — 180 mm — 230 mm — 350 mm — 550mm — 750 mm — 1000 mm

I valori indicati nei grafici sono da considerarsi indicativi e non considerano eventuali deformazioni dovute a fattori esterni.
The values indicated in the graphs are to be considered indicative and do not consider any deformations due to external factors.

Per scegliere l'attuatore Comunello Mowin più adatto, è necessario calcolare la FORZA (F) necessaria a sostenere il movimento della finestra. Il tipo di attuatore va selezionato considerando la combinazione tra la dimensione di BASE del serramento e la forza calcolata (N).

Formule per il calcolo della forza necessaria a movimentare il serramento

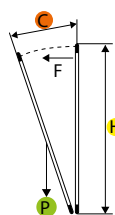

$$\frac{(C \div H) \times (P \div 2) = F \text{ Kg}}{F \text{ (Kg)} \times 9,8 = \mathbf{N F \text{ (N)}}$$

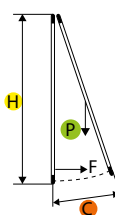

$$\frac{(C \div H) \times (P \div 2) = F \text{ Kg}}{F \text{ (Kg)} \times 9,8 = \mathbf{N F \text{ (N)}}$$

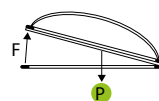

$$\frac{P \div 2 = F \text{ Kg}}{F \text{ (Kg)} \times 9,8 = \mathbf{N F \text{ (N)}}$$

F = Forza necessaria
Necessary Force (Kg)

C = Corsa di apertura
Opening stroke (mm)

H = Altezza serramento
Window height (mm)

P = Peso serramento
Window weight (Kg)

A45 - Portate attuatori a sporgere e cupola

A45 - Actuator force - top hung and dome

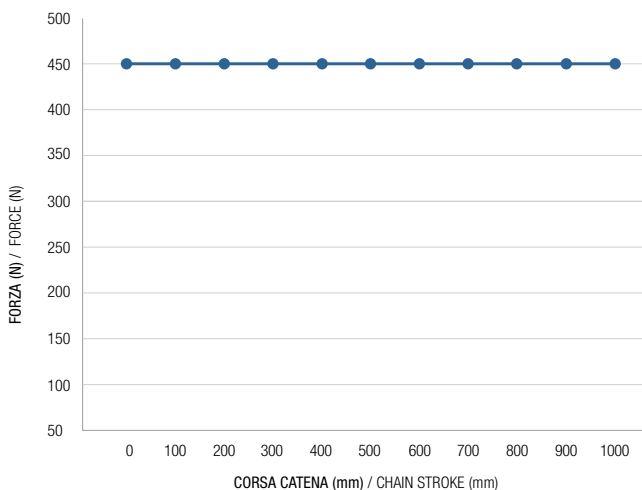

● SPORGERE / TOP HUNG OUTWARD OPENING CUPOLA / DOME

In order to choose the most suitable Comunello Mowin actuator, you have to calculate the necessary FORCE (F) to sustain the window movement. Choose the actuator type in accordance with the CALCULATED FORCE (N) and the FRAME DIMENSION.

Formulas for calculating the force necessary to move the window



L 1096 mm - C 1000 mm



L 846 mm - C 750 mm



L 646 mm - C 550 mm



L 446 mm - C 350 mm



L 336 mm - C 180 or 230 mm

Article	Product code	Colour	Strokes	Push / pull	Power	Power supply	Weight	Pcs
A45/180 230V basic	MA45 S1 18H OG 00	Grey RAL 7035	180 mm	450 N	36W	230 VAC	1,70 Kg	1
A45/230 230V basic	MA45 S1 23H OG 00	Grey RAL 7035	230 mm	450 N	36W	230 VAC	1,75 Kg	1
A45/350 230V basic	MA45 S1 35H OG 00	Grey RAL 7035	350 mm	450 N	36W	230 VAC	1,90 Kg	1
A45/550 230V basic	MA45 S1 55H OG 00	Grey RAL 7035	550 mm	450 N	36W	230 VAC	4,50 Kg	1
A45/750 230V basic	MA45 S1 75H OG 00	Grey RAL 7035	750 mm	450 N	36W	230 VAC	5,50 Kg	1
A45/1000 230V basic	MA45 S1 0AH OG 00	Grey RAL 7035	1000 mm	450 N	36W	230 VAC	6,00 Kg	1
A45/180 24V basic	MA45 S1 18L OG 00	Grey RAL 7035	180 mm	450 N	36W	24 VDC	1,70 Kg	1
A45/230 24V basic	MA45 S1 23L OG 00	Grey RAL 7035	230 mm	450 N	36W	24 VDC	1,75 Kg	1
A45/350 24V basic	MA45 S1 35L OG 00	Grey RAL 7035	350 mm	450 N	36W	24 VDC	1,90 Kg	1
A45/550 24V basic	MA45 S1 55L OG 00	Grey RAL 7035	550 mm	450 N	36W	24 VDC	4,50 Kg	1
A45/750 24V basic	MA45 S1 75L OG 00	Grey RAL 7035	750 mm	450 N	36W	24 VDC	5,50 Kg	1
A45/1000 24V basic	MA45 S1 0AL OG 00	Grey RAL 7035	1000 mm	450 N	36W	24 VDC	6,00 Kg	1

La confezione contiene:		Box contains:		
	Attuatore <i>Actuator</i>	Staffe di supporto <i>Support brackets</i>	Attacco per finestre <i>Fitting for windows</i>	Manuale d'uso <i>User manual</i>

Airwin A65



One Smart

24
VDC

Power

230
VAC

NV

W
NET
SYNC

Technology

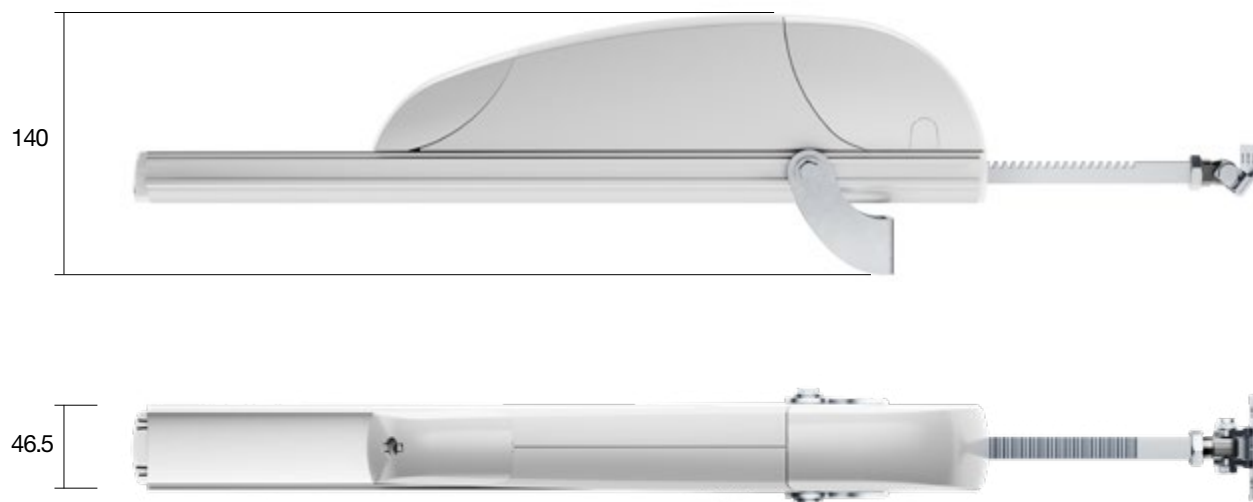

Caratteristiche principali

Main features

Installazione

Installation

Fissaggio della staffa regolabile lungo il binario del corpo dell'attuatore.

Fixing of the adjustable bracket along the rail of the actuator body.

Tecnologia W-Net

W-Net Technology

Grazie alla tecnologia W-Net è possibile installare fino a 4 attuatori sincronizzati nello stesso serramento.

Thanks to the W-Net technology it is possible to install up to 4 synchronized actuators in the same window.

Finecorsa apertura

Opening limit switch

Il finecorsa in apertura regolabile è garantito in maniera stabile e precisa dall'encoder.

The adjustable opening limit switch is guaranteed in a stable and precise manner by the encoder.

Caratteristiche tecniche / Technical data sheet

	Airwin A65 - 230 V	Airwin A65 - 24 V
Forza trazione / spinta / Thrust / traction force	650 N	650 N
Alimentazione / Power supply	230 VAC	24 VDC
Frequenza / Frequency	50 hz	-
Tipo di servizio / Type of service	s2 4min	s2 4min
Velocità a vuoto / Unloaded stroke speed	10 mm/s	10 mm/s
Corse disponibili / Strokes available	180 - 230 - 350 - 550 750 - 1000	180 - 230 - 350 - 550 750 - 1000
Temperatura di funzionamento / Operating temperature	-5°C + 50°C	-5°C + 50°C
Grado di protezione IP / IP protection class	44	44
Soft START / Soft STOP	Sì / Yes	Sì / Yes
Assorbimento / Current draw	0,36 A	1,85 A
Potenza assorbita / Power draw	45 W	45 W
Rilevamento ostacolo / Obstacle detection	Sì / Yes	Sì / Yes
Collegamento in parallelo / Connection in parallel	Sì / Yes (max 30 attuatori / max 30 actuators)	Sì / Yes (max 30 attuatori / max 30 actuators)
Sincronizzazione / Synchronisation	Sì / Yes	Sì / Yes
Dimensioni / Dimensions	L x 103 x 47mm	L x 103 x 47mm
Finecorsa in apertura / Open limit switch	Encoder	Encoder
Finecorsa in chiusura / Closed limit switch	Amperometrica / Amperometric	Amperometrica / Amperometric
Peso attuatore / Actuator weight	Variabile secondo la corsa Variable according to the stroke	Variabile secondo la corsa Variable according to the stroke

Finecorsa chiusura Closing limit switch

Il finecorsa in chiusura per assorbimento di corrente garantisce una chiusura stabile nel tempo.

The closing limit switch by current absorption guarantees stable closure over time.

Forza Force

Grazie alla forza di 650N di un singolo attuatore è possibile raggiungere una forza totale di 1820N con 4 AIRWIN A65 sincronizzati.

Thanks to the 650N force of a single actuator, it is possible to reach a total force of 1820N with 4 synchronized AIRWIN A65s.

A-Mech

È possibile collegare meccanicamente all'attuatore 1 o 2 cremagliere AIRWIN A MECH per ottenere un sistema a 2 o 3 punti spinta e garantire una chiusura più omogenea lungo tutta la lunghezza del serramento.

It is possible to mechanically connect 1 or 2 AIRWIN A MECH racks to the actuator to obtain a 2 or 3-point thrust system and ensure more uniform closure along the entire length of the window.

Airwin A65



Configurazione dell'attuatore Actuator configuration

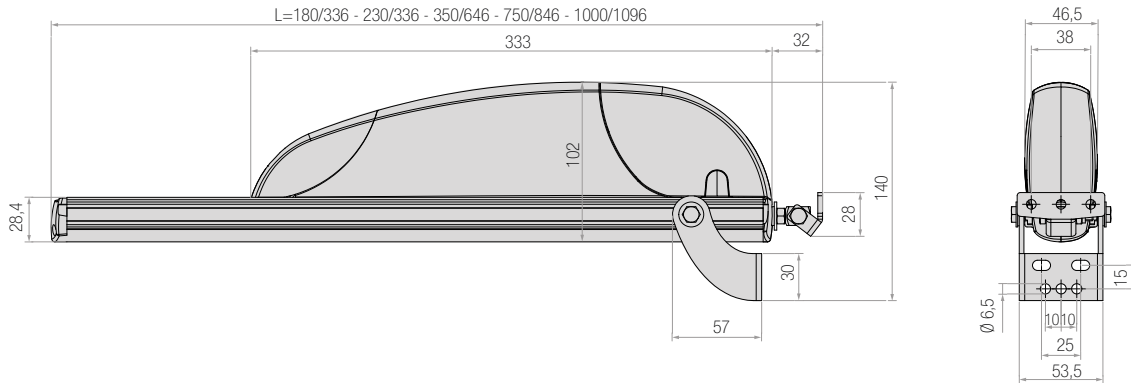

Formule per il calcolo della forza necessaria a movimentare il serramento *Formulas for calculating the force necessary to move the window*

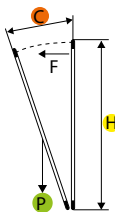

$$\frac{(C \div H) \times (P \div 2) = F \text{ Kg}}{F \text{ (Kg)} \times 9,8 = \mathbf{N F \text{ (N)}}$$

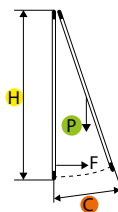

$$\frac{(C \div H) \times (P \div 2) = F \text{ Kg}}{F \text{ (Kg)} \times 9,8 = \mathbf{N F \text{ (N)}}$$

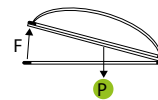

$$\frac{P \div 2 = F \text{ Kg}}{F \text{ (Kg)} \times 9,8 = \mathbf{N F \text{ (N)}}$$

F = Forza necessaria
Necessary Force (Kg)

C = Corsa di apertura
Opening stroke (mm)

H = Altezza serramento
Window height (mm)

P = Peso serramento
Window weight (Kg)



A65 - Angolo di apertura anta a sporgere
A65 - Top hung opening angle

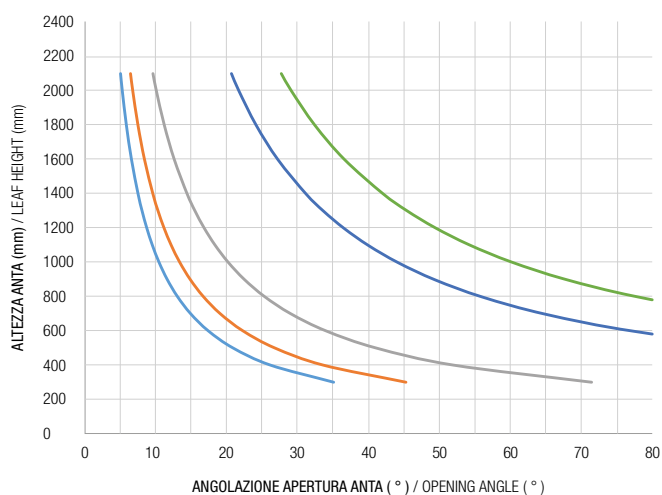

CORSA / STROKE — 180 mm — 230 mm — 350 mm — 550 mm — 750 mm — 1000 mm

I valori indicati nei grafici sono da considerarsi indicativi e non considerano eventuali deformazioni dovute a fattori esterni.
 The values indicated in the graphs are to be considered indicative and do not consider any deformations due to external factors.

A65 - Portate attuatori a sporgere e cupola
A65 - Actuator force - top hung and dome

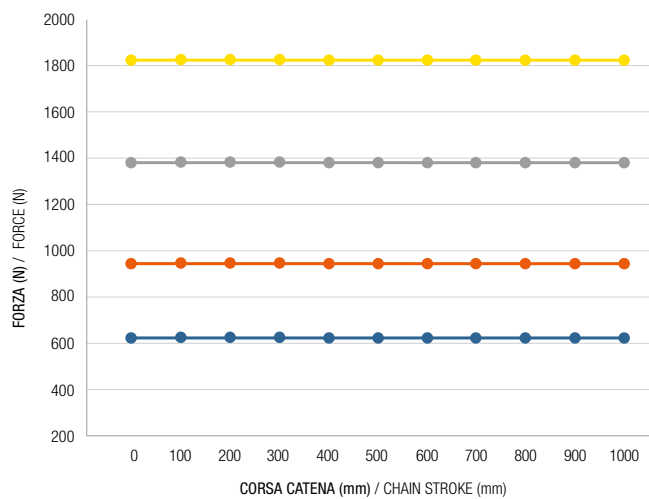

— SPORGERE / TOP HUNG OUTWARD OPENING CUPOLA / DOME
 — SPORGERE / TOP HUNG OUTWARD OPENING CUPOLA 2W NET / DOME 2W NET
 — SPORGERE / TOP HUNG OUTWARD OPENING CUPOLA 3W NET / DOME 3W NET
 — SPORGERE / TOP HUNG OUTWARD OPENING CUPOLA 4W NET / DOME 4W NET

Per scegliere l'attuatore Comunello Mowin più adatto, è necessario calcolare la FORZA (F) necessaria a sostenere il movimento della finestra. Il tipo di attuatore va selezionato considerando la combinazione tra la dimensione di BASE del serramento e la forza calcolata (N).

In order to choose the most suitable Comunello Mowin actuator, you have to calculate the necessary FORCE (F) to sustain the window movement. Choose the actuator type in accordance with the CALCULATED FORCE (N) and the FRAME DIMENSION.

La confezione contiene:		Box contains:		
	Attuatore Actuator		Staffe di supporto Support brackets	
			Attacco per finestre Fitting for windows	
				Manuale d'uso User manual

Airwin A65



Power



NV



Technology

Airwin A65

Article	Product code	Colour	Strokes	Push / pull	Power	Power supply	Weight	Pcs
A65/180 230V basic	MA65 S1 18H 0G 00	Grigio / Grey	180 mm	650 N	45W	230 VAC	1,70 Kg	1
A65/230 230V basic	MA65 S1 23H 0G 00	Grigio / Grey	230 mm	650 N	45W	230 VAC	1,75 Kg	1
A65/350 230V basic	MA65 S1 35H 0G 00	Grigio / Grey	350 mm	650 N	45W	230 VAC	1,90 Kg	1
A65/550 230V basic	MA65 S1 55H 0G 00	Grigio / Grey	550 mm	650 N	45W	230 VAC	4,50 Kg	1
A65/750 230V basic	MA65 S1 75H 0G 00	Grigio / Grey	750 mm	650 N	45W	230 VAC	5,50 Kg	1
A65/1000 230V basic	MA65 S1 0AH 0G 00	Grigio / Grey	1000 mm	650 N	45W	230 VAC	6,00 Kg	1
A65/180 24V basic	MA65 S1 18L 0G 00	Grigio / Grey	180 mm	650 N	45W	24 VDC	1,70 Kg	1
A65/230 24V basic	MA65 S1 23L 0G 00	Grigio / Grey	230 mm	650 N	45W	24 VDC	1,75 Kg	1
A65/350 24V basic	MA65 S1 35L 0G 00	Grigio / Grey	350 mm	650 N	45W	24 VDC	1,90 Kg	1
A65/550 24V basic	MA65 S1 55L 0G 00	Grigio / Grey	550 mm	650 N	45W	24 VDC	4,50 Kg	1
A65/750 24V basic	MA65 S1 75L 0G 00	Grigio / Grey	750 mm	650 N	45W	24 VDC	5,50 Kg	1
A65/1000 24V basic	MA65 S1 0AL 0G 00	Grigio / Grey	1000 mm	650 N	45W	24 VDC	6,00 Kg	1

Airwin A65 2W-NET

Article	Product code	Colour	Strokes	Push / pull	Power	Power supply	Weight	Pcs
A65/180 230V 2W-NET	MA65 S2 18H 0G 00	Grigio / Grey	180 mm	650 N	45W	230 VAC	3,40 Kg	2
A65/230 230V 2W-NET	MA65 S2 23H 0G 00	Grigio / Grey	230 mm	650 N	45W	230 VAC	3,50 Kg	2
A65/350 230V 2W-NET	MA65 S2 35H 0G 00	Grigio / Grey	350 mm	650 N	45W	230 VAC	3,80 Kg	2
A65/550 230V 2W-NET	MA65 S2 55H 0G 00	Grigio / Grey	550 mm	650 N	45W	230 VAC	4,50 Kg	2
A65/750 230V 2W-NET	MA65 S2 75H 0G 00	Grigio / Grey	750 mm	650 N	45W	230 VAC	5,50 Kg	2
A65/1000 230V 2W-NET	MA65 S2 0AH 0G 00	Grigio / Grey	1000 mm	650 N	45W	230 VAC	6,00 Kg	2
A65/180 24V 2W-NET	MA65 S2 18L 0G 00	Grigio / Grey	180 mm	650 N	45W	24 VDC	3,40 Kg	2
A65/230 24V 2W-NET	MA65 S2 23L 0G 00	Grigio / Grey	230 mm	650 N	45W	24 VDC	3,50 Kg	2
A65/350 24V 2W-NET	MA65 S2 35L 0G 00	Grigio / Grey	350 mm	650 N	45W	24 VDC	3,80 Kg	2
A65/550 24V 2W-NET	MA65 S2 55L 0G 00	Grigio / Grey	550 mm	650 N	45W	24 VDC	4,50 Kg	2
A65/750 24V 2W-NET	MA65 S2 75L 0G 00	Grigio / Grey	750 mm	650 N	45W	24 VDC	5,50 Kg	2
A65/1000 24V 2W-NET	MA65 S2 0AL 0G 00	Grigio / Grey	1000 mm	650 N	45W	24 VDC	6,00 Kg	2



Airwin A65 3W-NET

Article	Product code	Colour	Strokes	Push / pull	Power	Power supply	Weight	Pcs
A65/180 230V 3W-NET	MA65 S3 18H 0G 00	Grigio / Grey	180 mm	650 N	45W	230 VAC	5,10 Kg	3
A65/230 230V 3W-NET	MA65 S3 23H 0G 00	Grigio / Grey	230 mm	650 N	45W	230 VAC	5,25 Kg	3
A65/350 230V 3W-NET	MA65 S3 35H 0G 00	Grigio / Grey	350 mm	650 N	45W	230 VAC	5,70 Kg	3
A65/550 230V 3W-NET	MA65 S3 55H 0G 00	Grigio / Grey	550 mm	650 N	45W	230 VAC	6,75 Kg	3
A65/750 230V 3W-NET	MA65 S3 75H 0G 00	Grigio / Grey	750 mm	650 N	45W	230 VAC	8,25 Kg	3
A65/1000 230V 3W-NET	MA65 S3 0AH 0G 00	Grigio / Grey	1000 mm	650 N	45W	230 VAC	9,00 Kg	3
A65/180 24V 3W-NET	MA65 S3 18L 0G 00	Grigio / Grey	180 mm	650 N	45W	24 VDC	5,10 Kg	3
A65/230 24V 3W-NET	MA65 S3 23L 0G 00	Grigio / Grey	230 mm	650 N	45W	24 VDC	5,25 Kg	3
A65/350 24V 3W-NET	MA65 S3 35L 0G 00	Grigio / Grey	350 mm	650 N	45W	24 VDC	5,70 Kg	3
A65/550 24V 3W-NET	MA65 S3 55L 0G 00	Grigio / Grey	550 mm	650 N	45W	24 VDC	6,75 Kg	3
A65/750 24V 3W-NET	MA65 S3 75L 0G 00	Grigio / Grey	750 mm	650 N	45W	24 VDC	8,25 Kg	3
A65/1000 24V 3W-NET	MA65 S3 0AL 0G 00	Grigio / Grey	1000 mm	650 N	45W	24 VDC	9,00 Kg	3

Airwin A65 4W-NET

Article	Product code	Colour	Strokes	Push / pull	Power	Power supply	Weight	Pcs
A65/180 230V 4W-NET	MA65 S4 18H 0G 00	Grigio / Grey	180 mm	650 N	45W	230 VAC	6,80 Kg	4
A65/230 230V 4W-NET	MA65 S4 23H 0G 00	Grigio / Grey	230 mm	650 N	45W	230 VAC	7,00 Kg	4
A65/350 230V 4W-NET	MA65 S4 35H 0G 00	Grigio / Grey	350 mm	650 N	45W	230 VAC	7,60 Kg	4
A65/550 230V 4W-NET	MA65 S4 55H 0G 00	Grigio / Grey	550 mm	650 N	45W	230 VAC	9,00 Kg	4
A65/750 230V 4W-NET	MA65 S4 75H 0G 00	Grigio / Grey	750 mm	650 N	45W	230 VAC	11,00 Kg	4
A65/1000 230V 4W-NET	MA65 S4 0AH 0G 00	Grigio / Grey	1000 mm	650 N	45W	230 VAC	12,00 Kg	4
A65/180 24V 4W-NET	MA65 S4 18L 0G 00	Grigio / Grey	180 mm	650 N	45W	24 VDC	6,80 Kg	4
A65/230 24V 4W-NET	MA65 S4 23L 0G 00	Grigio / Grey	230 mm	650 N	45W	24 VDC	7,00 Kg	4
A65/350 24V 4W-NET	MA65 S4 35L 0G 00	Grigio / Grey	350 mm	650 N	45W	24 VDC	7,60 Kg	4
A65/550 24V 4W-NET	MA65 S4 55L 0G 00	Grigio / Grey	550 mm	650 N	45W	24 VDC	9,00 Kg	4
A65/750 24V 4W-NET	MA65 S4 75L 0G 00	Grigio / Grey	750 mm	650 N	45W	24 VDC	11,00 Kg	4
A65/1000 24V 4W-NET	MA65 S4 0AL 0G 00	Grigio / Grey	1000 mm	650 N	45W	24 VDC	12,00 Kg	4

Airwin A Mech



Utilizzo



Non incluso / Not included

Con l'accessorio A-MECH è possibile unire fino a 4 punti spinta, distribuendo la forza lungo tutto un serramento, anche di notevoli dimensioni

With the A-MECH accessory it is possible to join up to 4 push points, distributing the force throughout a window, even of considerable size

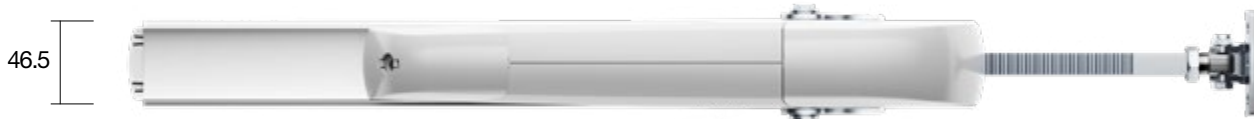

L 336 mm - Corsa / Stroke 180 - 230 mm



L 446 mm - Corsa / Stroke 350 mm



L 846 mm - Corsa / Stroke 750 mm



L 646 mm - Corsa / Stroke 550 mm



L 1096 mm - Corsa / Stroke 1000 mm

Configurazione dell'attuatore Actuator configuration



Sporgere
Top hung

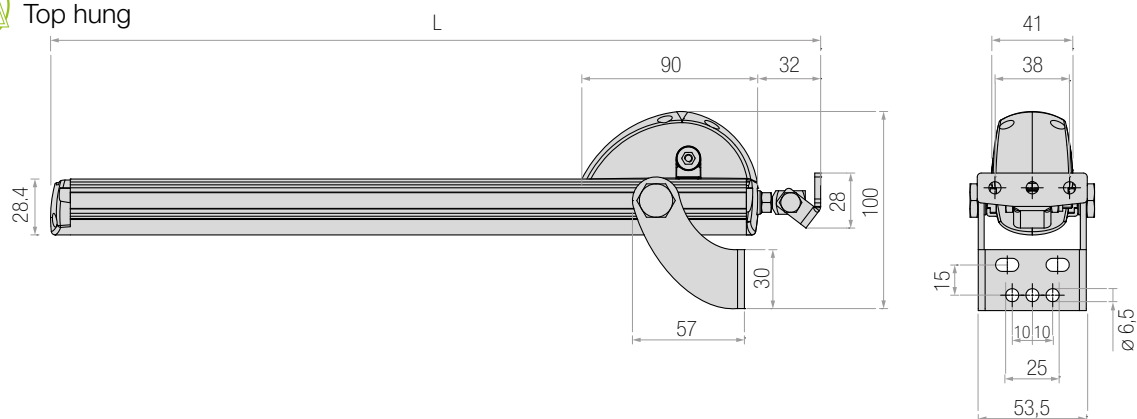

Article	Product code	Strokes	Colour	Weight	Pcs
A180 MECH	MA00 MC 18N OG 00	180 mm	Grigio / Grey	1,80 Kg	1
A230 MECH	MA00 MC 23N OG 00	230 mm	Grigio / Grey	2,00 Kg	1
A350 MECH	MA00 MC 35N OG 00	350 mm	Grigio / Grey	2,40 Kg	1
A550 MECH	MA00 MC 55N OG 00	550 mm	Grigio / Grey	3,10 Kg	1
A750 MECH	MA00 MC 75N OG 00	750 mm	Grigio / Grey	3,80 Kg	1
A1000 MECH	MA00 MC 0AN OG 00	1000 mm	Grigio / Grey	4,60 Kg	1

	La confezione contiene:	Box contains:		
	Attuatore Actuator	Staffe di supporto Support brackets	Attacco per finestre Fitting for windows	Manuale d'uso User manual
				



01 STAFFE DI SUPPORTO / SUPPORT BRACKETS

10 pieces x pack (1,60 Kg)

MR00 AS 01N OG 00 Zincato bianco / White zinc plated

02 ATTACCO PER FINESTRE / FITTING FOR WINDOWS

30 pieces x pack (2,05 Kg)

MR00 AA 01N OG 00 Zincato bianco / White zinc plated

04 BOCCOLE / COLLARS

10 coppie x pack (1,10 Kg)

MA00 XX 02N OG 00 Zincato bianco / White zinc plated

03 BARRA DI COLLEGAMENTO / CONNECTION BAR

MA00 AB 01N OG 00 L= 895 mm per interasse 1000 mm. Zincato bianco
10 pcs x pack (6,20 Kg) for 1000 mm centre distance. White zinc plated

MA00 AB 02N OG 00 L= 1395 mm per interasse 1500 mm. Zincato bianco
10 pcs x pack (9,60 Kg) for 1500 mm centre distance. White zinc plated

MA00 AB 03N OG 00 L= 1895 mm per interasse 2000 mm. Zincato bianco
10 pcs x pack (13,10 Kg) for 2000 mm centre distance. White zinc plated

MA00 AB 04N OG 00 L= 2395 mm per interasse 2500 mm. Zincato bianco
10 pcs x pack (16,60 Kg) for 2500 mm centre distance. White zinc plated

MA00 AB 05N OG 00 L= 2985 mm per interasse 3000 mm. Zincato bianco
10 pcs x pack (20,00 Kg) for 3000 mm centre distance. White zinc plated

→ Accessori per Ventilazione naturale

Accessories for natural ventilation



MCU RADIO

Centralina ventilazione naturale
Control unit - natural ventilation

cod. MX00AU02H0W00



MCU

Centralina ventilazione naturale
Control unit - natural ventilation

cod. MX00AU03H0W00



AF 950

Scheda decoupler: modulo per comando locale e centralizzato di attuatori 230 VAC

Decoupler board: module for local and centralized control of 230 VAC actuators

cod. MP00X003H00000



AF 960

Centralina per il controllo di due attuatori installati nello stesso serramento - Non compatibile con Fast e Raywin

Control unit for the control of two actuators installed on the same window - Not compatible with Fast and Raywin

cod. MP00E003H00000



Rilevatore di pioggia *Rain sensor*

cod. MX00AR01NOG00

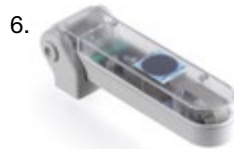

Rilevatore di pioggia trasparente *Transparent rain sensor*

cod. MX00AR01N0T00



Rilevatore vento sole *Wind sun sensor*

cod. MX00AR02N0T00

Attuatori compatibili / Compatible actuators



SMART



LIWIN



STAR



FAST



RAYWIN



AIRWIN



Schema elettrico MCU 230VAC versione Standard e Radio

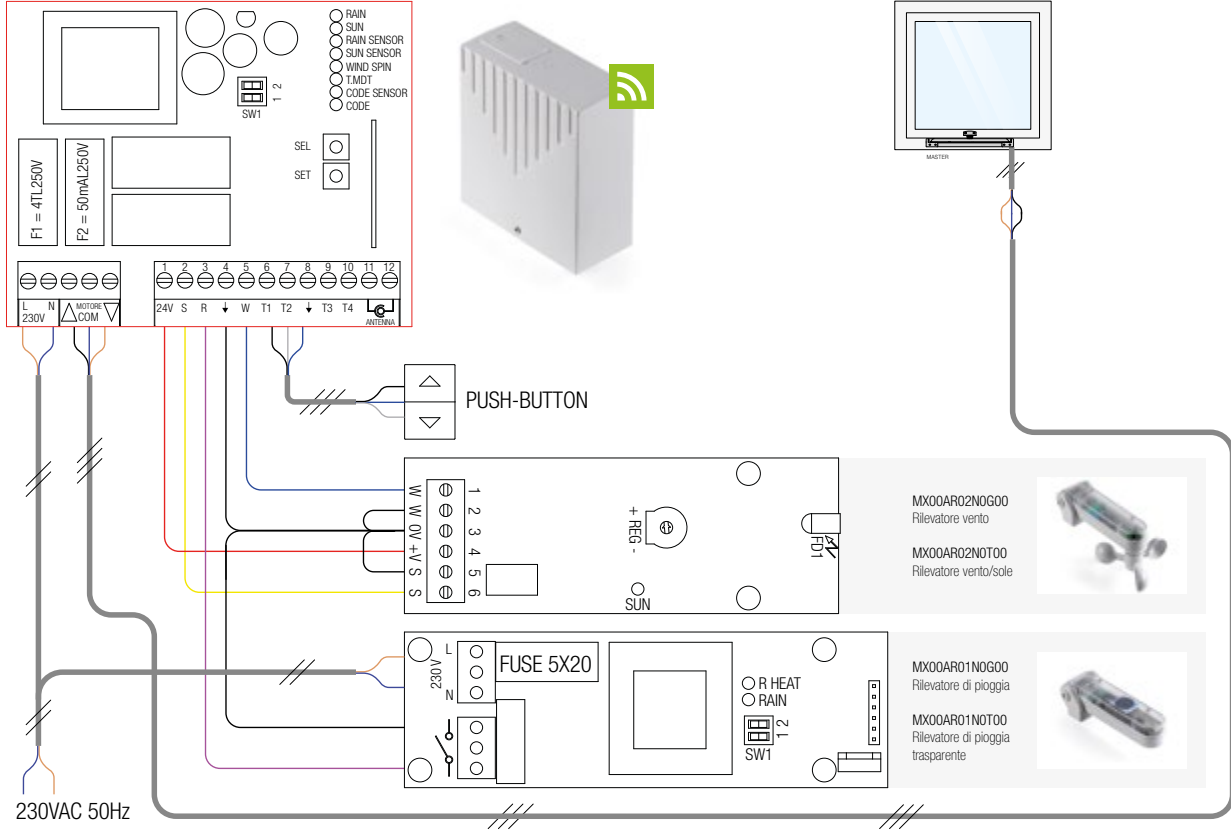

Schema collegamento elettrico AF 960

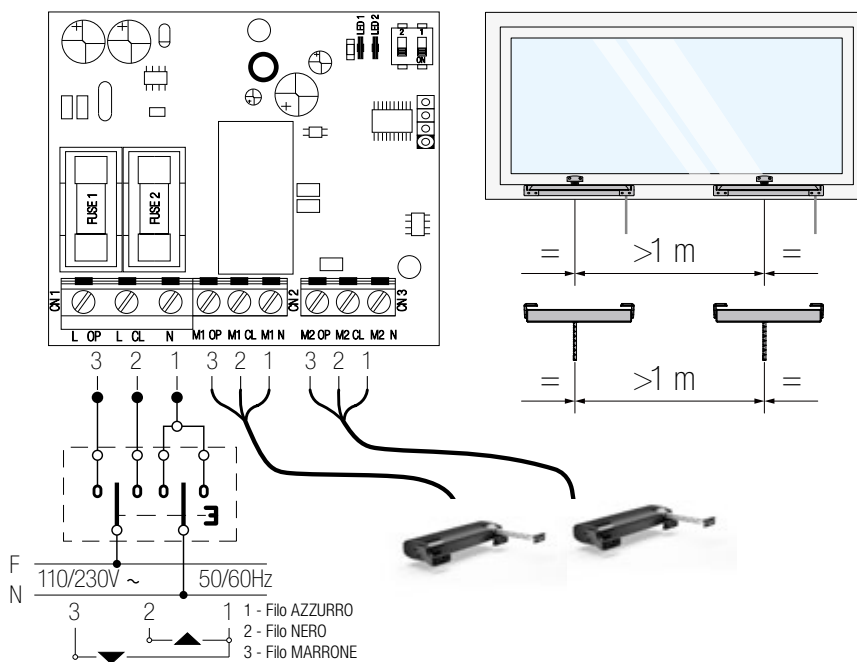

→ Accessori per Ventilazione Naturale

Accessories for Natural Ventilation



AF-920

Alimentatore da banco 24 VDC
Bench tester 24 VDC

cod. MX00AU04LOB00



AF-910

Alimentatore da banco 230 VAC
Bench tester 230 VAC

cod. MX00AU04H0B00

Attuatori compatibili / Compatible actuators



SMART



LIWIN



STAR



FAST



RAYWIN



AIRWIN

Schema collegamento alimentatore MX00AU04LOB00 per attuatori 24 VDC / MX00AU04LOB00 power supply connection diagram for 24 VDC actuators

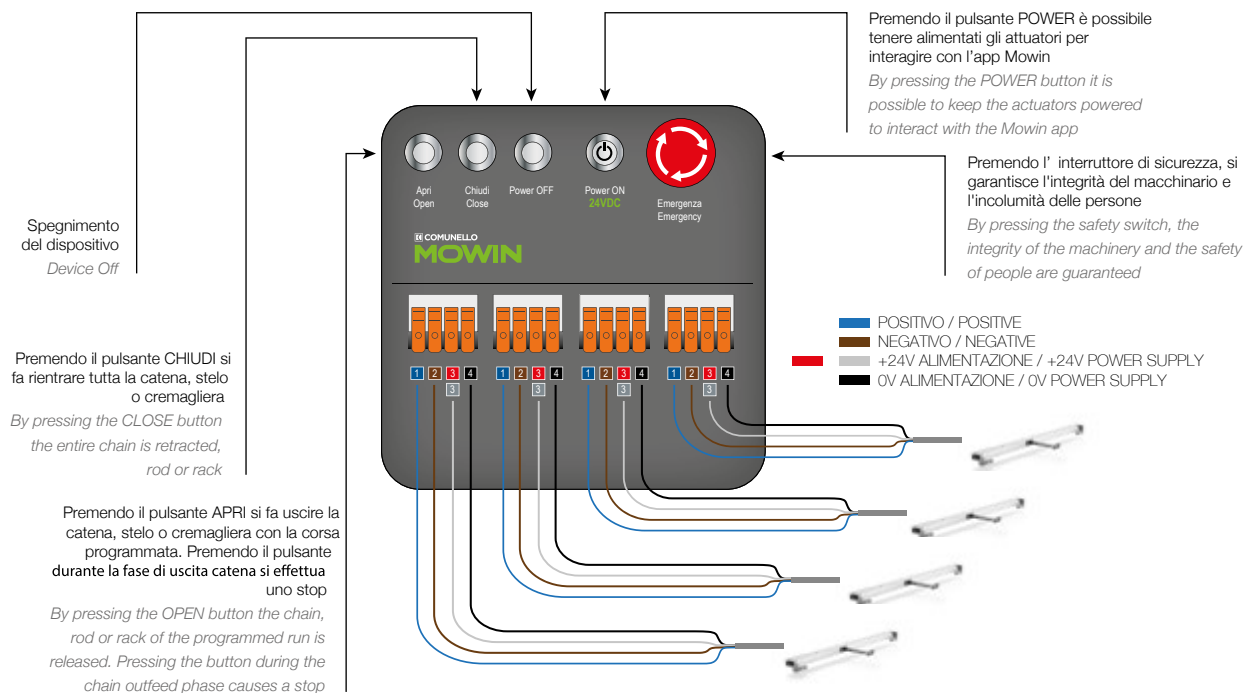

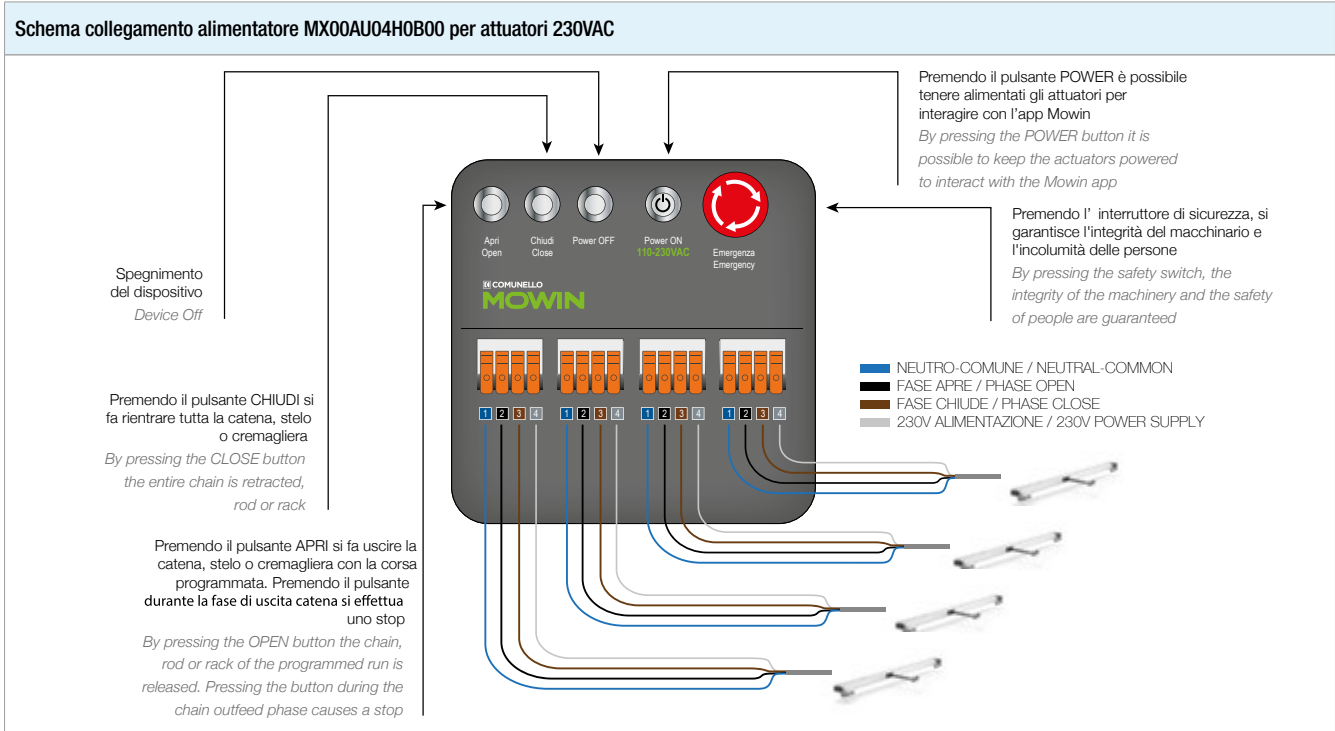











STAFFE ATTUATORI RWA / RWA ACTUATORS BRACKETS						
Product photo	Commercial code	Product code	Colour	Attuatori compatibili	Weight (Kg)	PCS
	Staffe di supporto	ML00AS01N0W00	BIANCO □	SMART	1,00 Kg	20
	Staffe di supporto	ML00AS01N0N00	NERO ■	SMART	1,00 Kg	20
	Staffe di supporto	ML00AS01N0G00	GRIGIO ■	SMART	1,00 Kg	20
	Staffe di supporto	ML00AS07N0W00	BIANCO □	STAR 25, STAR 30	0,16 Kg	10
	Staffe di supporto	ML00AS07N0B00	NERO ■	STAR 25, STAR 30	0,16 Kg	10
	Staffe di supporto	ML00AS07N0G00	GRIGIO ■	STAR 25, STAR 30	0,16 Kg	10
	Staffe di supporto versione alta	ML00AS03N0W00	BIANCO □	SMART	2,00 Kg	10
	Staffe di supporto versione alta	ML00AS03N0B00	NERO ■	SMART	2,00 Kg	10
	Staffe di supporto versione alta	ML00AS03N0G00	GRIGIO ■	SMART	2,00 Kg	10
	Staffe di supporto versione bassa	ML00AS05N0W00	BIANCO □	SMART	1,40 Kg	10
	Staffe di supporto versione bassa	ML00AS05N0B00	NERO ■	SMART	1,40 Kg	10
	Staffe di supporto versione bassa	ML00AS05N0G00	GRIGIO ■	SMART	1,40 Kg	10
	Staffe di supporto	MX00AS35N0W00	BIANCO □	L35	0,30 Kg	10
	Staffe di supporto	MX00AS35N0B00	NERO ■	L35	0,30 Kg	10
	Staffe di supporto	MX00AS35N0G00	GRIGIO ■	L35	0,30 Kg	10
	Staffe di supporto per abbaino	MX00SA35N0W00	BIANCO □	L40 L40 SLIM L35 L35 SLIM	0,19 Kg	10
	Staffe di supporto per abbaino	MX00SA35N0B00	NERO ■	L40 L40 SLIM L35 L35 SLIM	0,19 Kg	10
	Staffe di supporto per abbaino	MX00SA35N0G00	GRIGIO ■	L40 L40 SLIM L35 L35 SLIM	0,19 Kg	10
	Staffa di supporto per abbaino	ML00AS06N0W00	BIANCO □	STAR 30, STAR 25	0,16 Kg	20
	Staffa di supporto per abbaino	ML00AS06N0B00	NERO ■	STAR 30, STAR 25	0,16 Kg	20
	Staffa di supporto per abbaino	ML00AS06N0G00	GRIGIO ■	STAR 30, STAR 25	0,16 Kg	20

→ Accessori per Ventilazione Naturale

Accessories for Natural Ventilation



STAFFE ATTUATORI RWA / RWA ACTUATORS BRACKETS						
Product photo	Commercial code	Product code	Colour	Attuatori compatibili	Weight (Kg)	PCS
	Staffa di supporto	MFASTS01N0G00	GRIGIO ■	FAST	2,06 Kg	10
	Staffa di supporto	MR00AS01N0G00	GRIGIO ■	AIRWIN, RAYWIN	1,53 Kg	10
	Staffa di supporto	MX00AS2IN0W00	BIANCO □	L20 insert	0,36 Kg	20
	Staffa di supporto	MX00AS2IN0B00	NERO ■	L20 insert	0,36 Kg	20
	Staffa di supporto	MX00AS2IN0G00	GRIGIO ■	L20 insert	0,36 Kg	20
	Staffa di supporto per abbaino/incasso	MX00SA2IN0W00	BIANCO □	L20 insert	0,06 Kg	20
	Staffa di supporto per abbaino/incasso	MX00SA2IN0B00	NERO ■	L20 insert	0,06 Kg	20
	Staffa di supporto per abbaino/incasso	MX00SA2IN0G00	GRIGIO ■	L20 insert	0,06 Kg	20
	Attacco per finestre a sporgere	MX00SP00N0W00	BIANCO □	STAR 25, STAR 30, SMART, L35	0,24 Kg	30
	Attacco per finestre a sporgere	MX00SP00N0B00	NERO ■	STAR 25, STAR 30, SMART, L35	0,24 Kg	30
	Attacco per finestre a sporgere	MX00SP00N0G00	GRIGIO ■	STAR 25, STAR 30, SMART, L35	0,24 Kg	30
	Attacco per finestre a vasistas	MX00VA20N0W00	BIANCO □	STAR 25, STAR 30, SMART	0,60 Kg	20
	Attacco per finestre a vasistas	MX00VA20N0B00	NERO ■	STAR 25, STAR 30, SMART	0,60 Kg	20
	Attacco per finestre a vasistas	MX00VA20N0G00	GRIGIO ■	STAR 25, STAR 30, SMART	0,60 Kg	20
	Attacco per finestre a vasistas	MX00VA35N0W00	BIANCO □	L35	0,40 Kg	20
	Attacco per finestre a vasistas	MX00VA35N0B00	NERO ■	L35	0,40 Kg	20
	Attacco per finestre a vasistas	MX00VA35N0G00	GRIGIO ■	L35	0,40 Kg	20
	Attacco per finestre a vasistas	MX00VA2IN0W00	BIANCO □	L20 insert	0,30 Kg	20
	Attacco per finestre a vasistas	MX00VA2IN0B00	NERO ■	L20 insert	0,30 Kg	20
	Attacco per finestre a vasistas	MX00VA2IN0G00	GRIGIO ■	L20 insert	0,30 Kg	20
	Attacco per finestre a sporgere	MX00SP2IN0W00	BIANCO □	L20 insert	0,25 Kg	30
	Attacco per finestre a sporgere	MX00SP2IN0B00	NERO ■	L20 insert	0,25 Kg	30
	Attacco per finestre a sporgere	MX00SP2IN0G00	GRIGIO ■	L20 insert	0,25 Kg	30
	kit staffa supporto e attacco catena per applicazione ad incasso	MX00SI2IN0W00	BIANCO □	L20 insert	0,16 Kg	10
	kit staffa supporto e attacco catena per applicazione ad incasso	MX00SI2IN0B00	NERO ■	L20 insert	0,16 Kg	10
	kit staffa supporto e attacco catena per applicazione ad incasso	MX00SI2IN0G00	GRIGIO ■	L20 insert	0,16 Kg	10
	Attacco per finestre	MR00AA01N0G00	GRIGIO ■	FAST, RAYWIN, AIRWIN	2,04 Kg	30

→ Accessori R-Control

Accessories R-Control

Trasmittitore radio con frequenza 434,15 MHz
Radio transmitter with 434.15 MHz frequency



Codice	Articolo	Colore	Canali	Pcs/pack	Kg/pack
MX00AT01NOW00	R1 CONTROL	Bianco	1	1	0.09
MX00AT06NOW00	R6 CONTROL	Bianco	6	1	0.09
MX00AT01NYW00	R1 CONTROL	Giallo	1	1	0.09
MX00AT06NYW00	R6 CONTROL	Giallo	6	1	0.09
MX00AT01NVW00	R1 CONTROL	Verde	1	1	0.09
MX00AT06NVW00	R6 CONTROL	Verde	6	1	0.09
MX00AT01NGW00	R1 CONTROL	Grigio	1	1	0.09
MX00AT06NGW00	R6 CONTROL	Grigio	6	1	0.09
MX00AT01NAW00	R1 CONTROL	Arancio	1	1	0.09
MX00AT06NAW00	R6 CONTROL	Arancio	6	1	0.09

→ Smart home accessori

Smart home accessories



AF-800
Centrale di comando 110-240 V
Control unit 110-240 V

cod. MX00 AU 05 H 0W 00



AF-820
Centrale di comando
110-240 V Wi-Fi
Control unit 110-240 V Wi-Fi

cod. MX00 AU 06 H 0W 00



AF-840
Centrale di comando 110-240V
Control unit 110-240V

cod. MX00 AU 07 H 0W 00



AF-850
Centrale di comando
110-240 V Wi-Fi
Control unit 110-240 V Wi-Fi

cod. MX00 AU 08 H 0W 00



AF-860
Centrale di comando
12-24 VAC/DC Wi-Fi
Control unit 12-24 VAC/DC Wi-Fi

cod. MX00 AU 09 L 0W 00



AF-880
Radiocomando Rolling 1
Radiocomando 1 canale
Remote control 1 channel

cod. MX00 AT 11 N 0B 00



AF-890
Radiocomando Rolling 6
Radiocomando 6 canali
Remote control 6 channels

cod. MX00 AT 16 N 0B 00



AF-870
Pulsante radio Rolling
Radiocomando 1 canale
Remote control 1 channel

cod. MX00 AT 10 N 0W 00



Rilevatore vento sole
Wind sun sensor

cod. MX00 AR 02 N 0T 00



Rilevatore di pioggia
Rain sensor

cod. MX00 AR 01 N 0T 00

Attuatori compatibili / Compatible actuators





Sensori di pioggia e vento/sole.
Rain and wind/sun sensors.



Centrale di comando a scomparsa per controllo finestre e tapparelle motorizzate.
Concealed control unit for controlling motorized windows and rolling shutters.



Attivatore tramite pulsante radio Rolling.
Activator via Rolling radio button.



Assistente vocale di comando per la gestione dei dispositivi OneSmart tramite voce.
Command voice assistant for managing OneSmart devices via voice.



Radiocomando multi-canale per il controllo di finestre e tapparelle.
Multi-channel remote control for controlling windows and shutters.



Controllo remoto con Smartphone tramite connessione Wi-Fi.
Remote control with Smartphone via Wi-Fi connection.

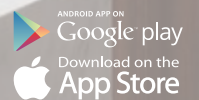

CONDIZIONI GENERALI DI VENDITA GENERAL TERMS OF SALE

1. GENERALITÀ

1.1 Il presente documento si rivolge ai clienti (di seguito "Clienti") di FRATELLI COMUNELLO SPA (di seguito solo COMUNELLO) con esso si intendono rendere note le condizioni contrattuali che COMUNELLO applicherà in tutte le vendite dei propri prodotti (di seguito CONDIZIONI GENERALI DI VENDITA), salvo diverse specifiche pattuizioni in deroga a quanto qui riportato, trattasi, in ogni caso, di condizioni che risultano vincolanti ed efficaci tra le parti ai sensi dell'art. 1341 Codice Civile.

1.2. COMUNELLO applica in tutti i rapporti contrattuali di vendita dei propri prodotti la legge italiana, salvo apposite deroghe che dovranno essere concordate e provate per iscritto

1.3 Le Condizioni Generali di Vendita qui riportate si riferiscono esclusivamente ai prodotti portanti il marchio COMUNELLO (di seguito "Prodotti").

2. OFFERTE – PREVENTIVI

2.1 Le offerte formulate da COMUNELLO ai propri Clienti conservano efficacia per un periodo massimo di 20 (venti) giorni dalla data di invio delle stesse, in ogni caso dovranno essere formalizzate per iscritto, anche a mezzo mail.

2.2. Decorso tale termine l'offerta formulata da COMUNELLO dovrà ritenersi decaduta e non accettabile da parte del CLIENTE, salvo diverso specifico accordo scritto tra le parti contrattuali

3. ORDINI

3.1 Gli ordini d'acquisto sottoscritti dai Clienti ed indirizzati a COMUNELLO dovranno essere confermati mediante apposito modulo predisposto da COMUNELLO (conferma d'ordine), che ciascun Cliente dovrà ritrasmettere a quest'ultima società, indicando, con precisione, il quantitativo della merce compravenduta e le ulteriori caratteristiche dei prodotti richiesti, previa apposizione della firma.

3.2 Il contratto d'acquisto si intende perfezionato e vincolante tra le parti mediante:

a) conferma dell'ordine d'acquisto da parte di FRATELLI COMUNELLO SPA;
b) con l'esecuzione materiale dell'ordine d'acquisto da parte di FRATELLI COMUNELLO, purché rispettoso del contenuto della vendita conclusa tra le parti.

3.3 Qualsiasi modifica o integrazione di singole disposizioni delle Condizioni Generali di Vendita o dell'ordine d'acquisto sono prive di efficacia se non sono state approvate per iscritto da COMUNELLO SPA. In caso di modifiche all'ordine d'acquisto, intervenute successivamente all'inoltro del modulo indicato al punto 3.1., le stesse non potranno considerarsi efficaci se nel frattempo COMUNELLO ha accettato l'ordine o vi ha dato esecuzione anche parziale, COMUNELLO si riserva comunque il diritto di annullare l'ordine d'acquisto originario e di sospendere l'esecuzione di quello in corso, chiedendo il risarcimento dei danni.

3.4 La data di consegna dei Prodotti indicata negli ordini d'acquisto ha sempre e comunque valore indicativo e l'eventuale ritardo rispetto a tale termine, per un periodo non superiore a 30 giorni, non potrà mai costituire ragione per il CLIENTE affinché questi possa avanzare pretese risarcitorie nei confronti di COMUNELLO o per risolvere il rapporto contrattuale.

In particolare COMUNELLO si riserva la facoltà di prorogare i termini di consegna per caso fortuito o forza maggiore o comunque per eventi non prevedibili al momento della conclusione della vendita (ad esempio, per difficoltà di approvvigionamenti di materie prime e componenti); qualora prima della consegna del materiale il CLIENTE versi in una situazione di difficoltà finanziaria o comunque modifichi la propria forma giuridica, COMUNELLO potrà procedere alla sospensione dell'esecuzione del rapporto contrattuale interrompendone immediatamente l'esecuzione, ed eventualmente risolvendo il contratto.-

4. CONSEGNA E SPEDIZIONE

4.1 I Prodotti vengono consegnati al CLIENTE nel luogo di produzione ovvero presso la sede legale di COMUNELLO (di seguito "Consegna").

4.2 Nel caso in cui i Prodotti siano consegnati Ex-works Rosà o Cassola (VI) INCOTERMS 2010, il passaggio del rischio si realizza dal momento della Consegna dei Prodotti da parte di FRATELLI COMUNELLO S.p.a. al Cliente od al vettore, il CLIENTE assume inoltre i costi del trasporto.

4.3 Salvo diverso accordo, FRATELLI COMUNELLO SPA stabilisce, in nome e per conto del Cliente, il tipo di spedizione, la via di trasporto e il vettore.

4.4 FRATELLI COMUNELLO SPA si riserva la facoltà di effettuare esecuzioni o Consegne parziali degli ordini d'acquisto. Il Cliente non potrà sollevare contestazione alcuna in ordine a consegne frazionate

e/o parziali. Tutte le Consegne parziali verranno fatturate autonomamente ed i termini di pagamento decorreranno dalla data di ciascuna fattura. Il pagamento delle Consegne parziali non potrà essere differito all'ultimazione delle Consegne relative all'ordine d'acquisto originario. Anche in caso di consegne parziali, troverà applicazione quanto stabilito dall'articolo 4.1.

5. PREZZI E LISTINI

5.1 Per prezzo si intende quello indicato nell'ultimo listino COMUNELLO per i Prodotti consegnati al Cliente, imballaggio normale compreso, e spese di spedizione escluse (di seguito "Prezzo"). L'ultimo listino emesso da FRATELLI COMUNELLO SPA annulla tutti i listini precedenti ed, in assenza di diverse pattuizioni, sarà quello applicabile alla vendita.

6. PAGAMENTO

6.1 Il pagamento del Prezzo dovrà avvenire entro il termine pattuito tra le parti contraenti. Il mancato pagamento del Prezzo entro il termine convenuto determinerà la decorrenza di interessi per il ritardo di pagamento nelle transazioni commerciali, nella misura prevista dal D.Lgs. n. 231 del 9.10.2002 e successive modifiche ed integrazioni. Tali interessi decorreranno dalla scadenza del termine di pagamento è fatto salvo il maggior danno subito da COMUNELLO.-

6.2 Il Cliente non potrà proporre domande né formulare eccezioni nei confronti di COMUNELLO se non dopo aver provveduto al pagamento del Prezzo.

6.3 In caso di irregolarità nei pagamenti, COMUNELLO si riserva il diritto di sospendere l'esecuzione di tutti gli ordini di acquisto, anche se diversi da quelli per i quali si è verificato il ritardo o l'inadempimento da parte del CLIENTE, senza alcun preavviso né diritto di risarcimento di alcun danno da parte del CLIENTE.

7. RESI E RECLAMI

7.1 Tutti i reclami devono essere formulati per iscritto entro 8 (otto) giorni dalla ricezione dei Prodotti, siano essi relativi alla quantità o alla qualità dei Prodotti consegnati.

7.2 I resi dei Prodotti consegnati verranno accettati da FRATELLI COMUNELLO SPA soltanto previo accordo scritto ed esclusivamente con riguardo a Prodotti nuovi e completi di imballaggio originale.

7.3 I resi dovranno essere accompagnati dall'apposito documento di trasporto di reso, indicante l'autorizzazione scritta di FRATELLI COMUNELLO SPA nonché la quantità e la qualità dei Prodotti.

7.4 I resi non potranno considerarsi accettati da FRATELLI COMUNELLO SPA se non effettuati con le modalità di cui sopra ed in particolare non potrà intendersi quale accettazione di resi la presa in consegna di Prodotti presso la sede o i depositi di FRATELLI COMUNELLO SPA.

7.5 Sulla somma accreditata riferita a resi non dovuti a cause imputabili a FRATELLI COMUNELLO SPA, verrà operata una riduzione del 30% da considerarsi alla stregua di una liquidazione forfetaria del danno (clausola penale), addebitata al Cliente in ragione dei costi generali, di spedizione, deperimento della merce, vetustà etc sopportati da COMUNELLO.

1. GENERAL INFORMATION

1.1 This document is intended for customers (hereinafter "Customers") of FRATELLI COMUNELLO SPA (hereinafter simply COMUNELLO); its purpose is to inform customers about the contractual conditions that COMUNELLO shall apply in all the sales of its products (hereinafter GENERAL TERMS AND CONDITIONS OF SALE), unless otherwise agreed in writing, and which, in any case, are binding on and effective between the parties pursuant to art. 1341 of the Italian Civil Code.

1.2. COMUNELLO applies the Italian law in all contractual relationships involving the sale of its products, save for any specific derogations to be agreed and proved in writing.

1.3 The General Terms and Conditions of Sale listed here exclusively refer to products bearing the COMUNELLO trademark (hereinafter the "Products").

2. OFFERS – QUOTES

2.1 The offers made by COMUNELLO to its Customers are effective for a maximum period of 20 (twenty) days from their submission; in any case they will have to be formalized in writing, including by email.

2.2. Upon expiry of the aforementioned deadline, the offer made by COMUNELLO shall be deemed cancelled and not acceptable by the CUSTOMER, unless otherwise specifically agreed in writing between the contracting parties

3. ORDERS

3.1 Purchase orders signed by the Customers and addressed to Comunello must be confirmed using the specific form prepared by Comunello (order confirmation), which each Customer has to sign and return to Comunello, precisely specifying the quantity of the goods bought and any additional features of the requested products.

3.2 The purchase contract shall be considered finalized and binding on the parties by means of:

a) confirmation of the purchase order by FRATELLI COMUNELLO SPA;
b) physical execution of the purchase order by FRATELLI COMUNELLO SPA, provided it is in compliance with the contents of the sale entered into between the parties.

3.3 Any amendment or addition to the individual provisions of the General Terms and Conditions of Sale or to the purchase order shall be ineffective unless approved in writing by COMUNELLO SPA. In the event changes are made to the purchase order after sending the form specified in paragraph 3.1., they shall have no effect if in the meantime Comunello has accepted the order or has implemented it in part; in any event, Comunello reserves the right to cancel the original purchase order and to suspend performance of the current one, requesting damages.

3.4 The Product delivery date specified in the purchase orders is always indicative and any delay of up to 30 days with respect to such deadline shall never constitute grounds for the CUSTOMER to claim damages against Comunello or to terminate the contractual relationship. More specifically, Comunello reserves the right to extend the delivery date due to unforeseeable circumstances or force majeure or in any case for circumstances that could not be foreseen at the time of the sale (for example, difficulty in procurement of raw materials and components); if prior to delivery, the CUSTOMER is in a difficult financial situation or changes its legal form, Comunello shall be entitled to suspend performance of, and possibly terminate the contract.

4. DELIVERY AND SHIPPING

4.1 The Products are delivered to the Customer at the production site or at the registered office of Comunello (hereinafter "Delivery").

4.2 If the Products are delivered Ex-works Rosà or Cassola (VI) Incoterms 2010, the risk is transferred upon delivery of the Products by FRATELLI COMUNELLO SPA to the Customer or to the carrier, the CUSTOMER being in charge of the transportation costs.

4.3 Unless otherwise agreed, FRATELLI COMUNELLO SPA shall establish, in the name and on behalf of the Customer, the type of shipment, the transport route and the carrier.

4.4 FRATELLI COMUNELLO SPA reserves the right to partially fulfil the purchase order or to partially deliver the products ordered. The Customer cannot raise any objection with regard to partial deliveries and/or deliveries made by instalments. All Partial deliveries shall be invoiced individually and the payment time limits shall run from the date of each invoice. The payment of partial Deliveries may not be deferred until completion of all the Deliveries related to the original purchase order. The provisions of Article 4.1 shall also apply to partial deliveries.

5. PRICES AND PRICE LISTS

5.1 The price is as specified in the last Comunello price list for the products delivered to the Customer, including normal packaging and excluding shipping costs (hereinafter the "Price"). The last price list issued by FRATELLI COMUNELLO SPA cancels all previous price lists and, unless otherwise agreed, it shall be applicable to the sale.

6. PAYMENT

6.1 Payment of the Price has to be made within the time limit agreed between the contracting parties. Failure to pay the price within the agreed time limit shall result in the application of interest for late payment in commercial transactions, to the extent provided by Legislative Decree No. 231 of 9.10.2002 as amended and supplemented. Default interest shall run from the expiry of the payment due date, subject to COMUNELLO's right to seek compensation for any further damage.

6.2 The Customer may not make claims or raise objections against Comunello until the Price has been paid.

6.3 In the event of irregular payments, Comunello reserves the right to suspend the performance of all purchase orders, including those not affected by the delay or default by the CUSTOMER, without notice and with no right to compensation for the CUSTOMER.

7. RETURNS AND COMPLAINTS

7.1 Any complaints referring to either the quantity or the quality of the delivered Products must be made in writing within 8 (eight) days from receipt of the Products.

7.2 The Products returned shall be accepted by FRATELLI COMUNELLO SPA only after written agreement and exclusively with regard to new Products with their original packaging.

7.3 The Products must be returned using the appropriate transport document specifying the written permission of FRATELLI COMUNELLO SPA as well as the quantity and quality of the Products.

7.4 Returns shall not be considered accepted by FRATELLI COMUNELLO SPA unless they are returned in the manner specified above and, specifically, taking delivery of the Products at the headquarters or at the warehouses of FRATELLI COMUNELLO SPA may not be construed as acceptance of the returns.

7.5 The amount credited for returns not due to causes attributable to FRATELLI COMUNELLO SPA, shall be subject to a 30% deduction, to be regarded as a flat-rate assessment of the damage (penalty clause), charged to the Customer on account of the general, shipping, goods deterioration, age etc. costs incurred by COMUNELLO.

8. GARANZIA

8.1 La presente garanzia nei rapporti commerciali o in caso di vendita di beni per uso professionale è limitata alla riparazione o sostituzione del pezzo del Prodotto riconosciuto da FRATELLI COMUNELLO SPA quale difettoso mediante Prodotti rigenerati equivalenti (di seguito "Garanzia Convenzionale"), non risulta compresa nella garanzia il costo necessario per le attività di riparazione e sostituzione del materiale (a titolo esemplificativo costi di manodopera, noleggio materiali, etc.).

8.2 È esclusa l'applicazione della disciplina dettata dagli articoli 1490-1495 del Codice Civile,

8.3 FRATELLI COMUNELLO SPA garantisce il funzionamento dei Prodotti nei limiti indicati al superiore punto sub 8.1.. Salvo diverso accordo, la validità della Garanzia Convenzionale è di 24 (ventiquattro) mesi dalla data di produzione, rilevabile sui Prodotti. Per gli attuatori della linea Showin la garanzia è di 60 (sessanta) mesi dalla data di produzione, mentre per i restanti prodotti della linea Automation Frame la garanzia è di 36 (trentasei) mesi dalla data di produzione. La Garanzia risulterà efficace e vincolante per COMUNELLO solo se il prodotto verrà correttamente montato e manutentato in conformità alle regole di installazione e di sicurezza indicate nella documentazione fornita da COMUNELLO o comunque rinvenibile sul sito www.comunello.com

8.4 La garanzia non comprende: avarie o danni causati dal trasporto; avarie o danni causati da vizi dell'impianto elettrico presente presso l'acquirente il prodotto e/o da trascuratezza, negligenza, inadeguatezza, uso anomalo di tale impianto; avarie o danni dovuti a manomissioni poste in essere da parte di personale non autorizzato o conseguenti allo scorretto uso/installazione (a questo proposito, si consiglia una manutenzione del sistema almeno ogni sei mesi) o all'impiego di pezzi di ricambio non originali; difetti causati da agenti chimici e/o fenomeni atmosferici. La garanzia non comprende il costo

per materiale di consumo, in ogni caso COMUNELLO matura il credito per l'intervento eseguito presso il cliente, laddove quest'ultimo si riveli inutile poiché non risultava operante la garanzia o perché il cliente aveva utilizzato il prodotto COMUNELLO in modo negligente, imprudente od imperito, tale per cui il corretto utilizzo del prodotto avrebbe potuto evitare l'installazione.-

8.5 Termini attuativi: salvo diverso accordo, il diritto alla Garanzia Convenzionale si esercita esibendo copia del documento di acquisto (fattura fiscale) a COMUNELLO. Il Cliente deve denunciare il difetto a COMUNELLO entro il termine di decadenza di 30 (trenta) giorni dalla scoperta.

L'azione deve essere esercitata entro il termine di prescrizione di 6 (sei) mesi dalla scoperta. I pezzi dei Prodotti per i quali viene richiesta l'attivazione della Garanzia Convenzionale devono essere spediti dal Cliente presso FRATELLI COMUNELLO S.p.a., Via Cassola 64, 36027 Rosà (VI) Italia.

8.6 Il Cliente non potrà richiedere il risarcimento di danni indiretti, mancati profitti, perdita di produzione ed in ogni caso non potrà pretendere a titolo di risarcimento somme superiori al valore dei componenti o dei Prodotti forniti. Tutte le spese per il trasporto dei Prodotti da riparare o riparati, anche se coperti dalla Garanzia Convenzionale, sono a carico del Cliente.

8.7 Nessun intervento esterno effettuato dal personale tecnico di COMUNELLO è coperto dalla Garanzia Convenzionale.

8.8 Modifiche specifiche delle condizioni della Garanzia Convenzionale qui descritte possono essere definite dalle parti nei propri contratti commerciali.

9. RIPARAZIONI OLTRE IL TERMINE DI GARANZIA

9.1 Le riparazioni dei Prodotti richieste dal Cliente verranno effettuate da FRATELLI COMUNELLO SPA, previo accordo sul costo dell'intervento. In ogni caso le spese per la manodopera e quelle di spedizione (andata e ritorno) rimarranno a carico del Cliente.

10. RISERVA DI PROPRIETÀ

10.1 I Prodotti forniti al CLIENTE, rimangono di proprietà di FRATELLI COMUNELLO SPA fino al saldo integrale del Prezzo da parte del Cliente, indipendentemente da chi abbia la detenzione dei Prodotti. Le spese di trasporto e le altre necessarie al recupero dei Prodotti così come le spese straordinarie e quelle ripetibili, saranno a carico del Cliente.

11. BREVETTI, MARCHI E SEGNI DISTINTIVI

11.1 Il Cliente è a conoscenza del fatto che i Prodotti sono coperti da brevetti e sono oggetto di Know-How e design costituenti proprietà esclusiva di FRATELLI COMUNELLO SPA, a norma del Codice della Proprietà Industriale.

11.2 È fatto espresso divieto al Cliente di violare tali diritti di FRATELLI COMUNELLO SPA ed in ogni caso il Cliente non potrà in alcun modo rimuovere, sopprimere o comunque alterare marchi ed altri segni distintivi o sigle di qualsiasi genere apposti ai Prodotti, così come è fatto divieto di apporre di nuovi di qualsiasi natura. È vietata inoltre qualsiasi forma di riproduzione od utilizzo del marchio FRATELLI COMUNELLO SPA e di ogni altro segno distintivo presente sui Prodotti, salvo autorizzazione scritta di FRATELLI COMUNELLO SPA.

12. CLAUSOLA RISOLUTIVA ESPRESSA

12.1 Ai sensi e per gli effetti dell'articolo 1456 del Codice Civile, il ritardato pagamento superiore ai dieci giorni, o il mancato pagamento, anche solo parziale, del Prezzo da parte del Cliente, secondo le modalità di cui all'articolo 6 delle presenti Condizioni Generali di Vendita, comporterà la risoluzione del contratto di acquisto, con diritto per FRATELLI COMUNELLO SPA di chiedere al Cliente il risarcimento dei danni patiti, oltre alla restituzione dei Prodotti rispetto ai quali il Cliente non abbia pagato il Prezzo.

12.2 La comunicazione di cui al punto precedente sarà trasmessa tramite raccomandata A.R. o tramite Pec.

13. ACCORDI TRA LE PARTI

13.1 In caso di accordi, preesistenti o sopravvenuti, tra FRATELLI COMUNELLO SPA ed il Cliente, in relazione a resi e modalità di pagamento, tali accordi prevarranno su quanto a riguardo stabilito dalle Condizioni Generali di Vendita.

14. LEGGE APPLICABILE E FORO COMPETENTE

14.1 I contratti di acquisto conclusi secondo le Condizioni Generali di Vendita sono soggetti esclusivamente alla legge italiana, con esclusione di qualsiasi altra legislazione.

14.2 Tutte le controversie che dovessero sorgere in merito ai suddetti contratti d'acquisto saranno assoggettate alla giurisdizione italiana e rimesse alla competenza esclusiva del Tribunale di Vicenza, anche se il pagamento sia convenuto a mezzo ricevuta bancaria o tratta domiciliata presso il Cliente.

(Italia). Il contenuto di questo catalogo è da ritenersi suscettibile di modifica in qualsiasi momento e senza obbligo di preavviso da parte di Fratelli Comunello SPA.

8. WARRANTY

8.1 In business relationships or in case of products sold for professional use, this warranty is limited to the repair or replacement of product parts that FRATELLI COMUNELLO SPA acknowledges as defective, through equivalent re-manufactured Products (the "Conventional Warranty"); the warranty does not include the costs necessary for repairing or replacing the material (e.g. labour costs, rental of equipment etc.) -

8.2 The provisions contained in articles 1490 to 1495 of the Italian Civil Code shall not apply.

8.3 FRATELLI COMUNELLO SPA warrants the proper operation of the products within the limits indicated in 8.1 above. Unless otherwise agreed, the validity of the Conventional Warranty is 24 (twenty four) months from the production date, which can be found on the products. For actuators of the Showin line the warranty is 60 (sixty) months from the production date, while for the remaining products of the Automation Frame Line the warranty is 36 (thirty six) months from the production date. The Warranty shall be effective and binding on COMUNELLO only if the product has been correctly installed and maintained in accordance with the installation and safety rules set out in the documentation provided by COMUNELLO or otherwise available on the website www.comunello.com

8.4 The warranty does not cover: failures or damage caused by transport; failures or damage caused by defects in the electrical system of the buyer and/or by carelessness, negligence, inadequate or abnormal use of such system; failure or damage due to tampering carried out by unauthorized personnel or due to incorrect use / installation (in this regard, system maintenance at least every six months is recommended) or the use of non-original spare parts; defects caused by chemical agents and/or atmospheric phenomena. The warranty does not cover the cost

of consumables; in any event, COMUNELLO shall be entitled to a consideration for the work performed at the Customer, where such work proves useless as the warranty did not apply or because the customer had used the Comunello product in a negligent, reckless or incompetent manner, such that the proper use of the product could have avoided the work.

8.5 Implementation terms: unless otherwise agreed, the right to the Conventional Warranty is exercised by showing a copy of the purchase document (invoice) to COMUNELLO. Any defect must be notified to COMUNELLO within the time limit of thirty (30) days from detection of the defect.

The action must be exercised within the limitation period of 6 (six) months from detection of the defect. The Product parts for which the Customer requests application of the Conventional Warranty must be returned by the Customer to FRATELLI COMUNELLO SPA, Via Cassola 64, 36027 Rosà (VI) Italy.

8.6 The Customer cannot claim compensation for indirect damage, loss of profits, loss of production and in any case it cannot claim compensation for an amount that exceeds the value of the supplied components or products. All transport costs for Products that have been repaired or to be repaired, although covered by the Conventional Warranty, shall be charged to the Customer.

8.7 No external work carried out by Comunello technical staff is covered by the Conventional Warranty.

8.8 Specific amendments to the Conventional Warranty conditions described herein can be defined by the parties in their commercial contracts.

9. REPAIRS AFTER EXPIRATION OF THE WARRANTY

9.1 The Product repairs requested by the Customer shall be carried out by FRATELLI COMUNELLO SPA, subject to prior agreement on the cost of the work. In any case, labour and transport costs (return) shall be charged to the customer.

10. RESERVATION OF TITLE

10.1 The Products delivered to the CUSTOMER shall continue to be the property of FRATELLI COMUNELLO SPA until full payment of the Price by the Customer, regardless of who has possession of the Products. Transport costs and other costs necessary to recover the Products as well as extraordinary expenses and those that can be recovered, shall be charged to the Customer.

11. PATENTS, TRADEMARKS AND DISTINCTIVE MARKS

11.1 The Customer is aware that the Products are covered by patents and incorporate know-how and design that are the exclusive property of FRATELLI COMUNELLO SPA, pursuant to the Italian Industrial Property Code.

11.2 The Customer is expressly forbidden from infringing such FRATELLI COMUNELLO SPAs rights; in any case, the Customer may not in any way remove, delete or otherwise alter the trademarks or other signs or distinctive marks of any kind affixed to Products; the Customer is likewise forbidden from affixing new ones of any kind. Any form of reproduction or use of the FRATELLI COMUNELLO SPA trademark and of any other distinctive mark on the Products is forbidden, without written authorization by FRATELLI COMUNELLO SPA.

12. EXPRESS TERMINATION CLAUSE

12.1 Pursuant to article 1456 of the Italian Civil Code, any delay of more than ten days in the payment, or any non-payment of the Price, including partial, by the Client, as provided for in Article 6 of these General Terms and Conditions of Sale, shall result in termination of the purchase contract and FRATELLI COMUNELLO SPA shall be entitled to seek compensation from the Customer for the damage suffered, in addition to restitution of the Products not paid by the Customer.

12.2 The notice referred to in the previous paragraph shall be sent by registered mail with return receipt or via certified email address (Pec).

13. AGREEMENT BETWEEN THE PARTIES

13.1 Any agreements, existing or that will take place between FRATELLI COMUNELLO SPA and the Customer, in relation to returns and payment methods, shall prevail over the provisions of these General Terms and Conditions of Sale.

14. APPLICABLE LAW AND JURISDICTION

14.1 The purchase contracts entered into in accordance with the General Terms and Conditions of Sale are subject to Italian law only, with the exclusion of any other legislation.

14.2 All disputes that may arise on the mentioned purchase contracts shall be subject to Italian jurisdiction and referred to the exclusive competence of the Court of Vicenza, including if the agreed payment method is by bank collection order or draft payable at the customer's.

(Italy). The content of this catalogue is subject to change at any time and without notice by FRATELLI COMUNELLO SPA.

COMUNELLO MOWIN

Le immagini, i disegni tecnici e le relative specifiche appartengono a Fratelli Comunello SpA e sono protetti dalle leggi sul copyright. Ogni utilizzo non espressamente autorizzato sarà perseguito legalmente. Le specifiche dei prodotti sono soggette a cambiamenti senza preavviso. Possono essere richiesti su specifiche del cliente articoli con altre misure oppure a disegno. Foto immagini e disegni sono puramente indicativi. Fratelli Comunello SpA si riserva il diritto di apportare qualsiasi tipo di variazione, anche senza preavviso, al fine di aggiornare e migliorare il catalogo in qualsiasi momento. Fratelli Comunello SpA non risponde per eventuali errori tipografici o descrizioni errate di prodotti e Plus di prodotto.

All images, technical drawings and specifications are the exclusive property of Fratelli Comunello SpA and are protected by International Copyright laws. Any unauthorised use will result in legal proceedings. Fratelli Comunello SpA reserves the right to alter technical specifications at any time without notice. Clients may request bespoke products of different sizes and/or based on customised designs. All photographs and other images shown are for informational purposes only. Fratelli Comunello SpA reserves the right to make any kind of alteration, at any time and without prior notice so as to update and improve the catalogue. Fratelli Comunello SpA is not liable for any errors or other mistakes in the technical descriptions and technical characteristics of the products shown.

HELP DESK **+39 0424 585 111**

CONSULENZA TECNICA IN CANTIERE
PROFESSIONAL ON-SITE TECHNICAL SERVICE

TECHNICAL INFORMATION
www.comunello.com

FRATELLI COMUNELLO S.P.A.

Via Cassola, 64 - C.P. 79

36027 Rosà, Vicenza, Italy

Tel. +39 0424 585111 Fax +39 0424 533417

info@comunello.it www.comunello.com



Concept and design: Caseley Giovara Srl

Printed in Italy

JOB10315 CATALOGO MOWIN Rev. 01 (07/2023)







COMUNELLO GROUP

INNOVATING TOGETHER